

# **RULE ON FIRE SAFETY OF BUILDINGS**

**- 2024 -**

**SECOND DRAFT**

# CHAPTER 1

## 1. GENERAL PROVISIONS

### SECTION I

#### 1.1. Subject matter, scope

**Article 11.1 (1)** This Rule sets out the main conditions, performance and performance levels for construction works, so that they meet the fundamental requirement of 'fire safety' according to Law No 10/1995 on quality in construction, republished, as amended.

(2) The measures provided for in this Rule are minimal and are not restrictive.

**Article 1.1.2. (1)** The general provisions, the common and specific performance of the Rule, including the annexes thereof, are binding on all the actors involved in the design, construction and operation of buildings, namely designers, project verifiers, technical experts, executors, consultants, execution technicians, site supervisors, owners under any title and users of buildings, as well as public administration authorities and control bodies, according to their obligations and responsibilities according to the legal provisions.

(2) The fire safety measures provided for construction works must meet the conditions, criteria and performance levels laid down in this Rule.

**Article 1.1.3.** In order to meet the basic requirement 'fire safety', buildings, as a whole and in their component parts, must be designed, constructed, equipped and used according to the provisions of this Rule, the relevant technical regulations and the technical regulations specific to their intended use, so that in the event of fire:

- a) the stability of the load-bearing elements is ensured during the predetermined time period;
- b) the occurrence and propagation of fire and smoke within the construction is limited;
- c) the spread of fire to and from neighbouring buildings is limited;
- d) users are able to leave the building or be rescued by other acceptable means;
- e) the security of the intervention teams is taken into account.

**Article 1.1.4. (1)** The provisions of this Rule on the fire safety of buildings are mandatory for the design and execution of new constructions, as well as intervention works on existing constructions, irrespective of the form of ownership, destination, category and class of importance or source of financing, in order to protect the lives of people, their property, society and the environment.

(2) When intervention works are carried out on existing buildings built on the basis of this Rule, where it is justified in technical terms that no standardised fire safety provisions can be met, alternative protective measures (passive, active or combinations thereof) shall be provided to meet the requirements that cannot be complied with.

(3) Modification of existing buildings constituting a building stock prior to the date of entry into force of the Rule shall comply with the requirements of **Chapter 9** of this Rule.

**Article 1.1.5. (1)** For historic or architectural monuments classified according to the law, the provisions of this Rule shall be of a recommendatory nature, following that only the fire safety improvement measures that may be achieved and that do not affect the character of the respective monuments are ensured.

(2) Measures to improve the fire safety which may be carried out and which do not affect the character of the monuments concerned shall be carried out on the basis of a technical expert opinion for the fundamental requirement of fire safety and the measures proposed by the technical expert to improve the fire safety requirement shall be taken with the approval of the competent

ministry. The assessment of the fire risk which represents the process of estimating and quantifying the risk associated with a system, referred to as existing fire risk, determined on the basis of the likelihood of the fire occurrence and the consequences of the occurrence of the event, as well as comparing it to a predetermined limit level, referred to as an accepted fire risk, is an additional way in which a historic monument building may also be assessed and subsequently, on the basis of a technical expert report, measures which are possible to be carried out and which do not affect the character of that monument may be taken to improve the fire safety.

**Article 1.1.6. (1)** The provisions of the Rule shall not apply to the design and implementation of:

- a) production facilities, systems, machinery, aggregates, devices and equipment;
- b) constructions and installations intended for the manufacture, handling and/or storage of pyrotechnic substances;
- c) outdoor chemical and petrochemical technology installations;
- d) nuclear constructions and installations;
- e) constructions and installations relating to buildings for the production of electrical energy;
- f) underground constructions and installations related to the metro;
- g) constructions and facilities specific to site organisations;
- h) special constructions and installations of national defence, public order and national security structures, nominated by orders of the headquarters of those structures;
- i) engineering constructions: communication routes (roads, railways, bridges, tunnels (excluding building drains and underground technical channels, runways, etc.), special industrial constructions (chimney sweeps, cooling towers, antennas, bunkers, silos, water towers, gondolas or other cableway transport systems, transport lines for electricity and technological fluids, sewage systems and the like);
- j) outdoor storages for liquids or gases and related technological facilities;
- k) service stations regardless of their type;
- l) LPG distribution systems to household or industrial customers;
- m) maritime platforms;
- n) heliports installed on buildings.

*Note: the organisation of the premises, the location of machinery and equipment and the safety and fire safety requirements will be taken from the specific Design, Execution and Operation Rules existing in the legislation.*

**(2)** Agrozootechnical buildings shall be treated by deeming it to be civil or production or storage constructions, depending on their destination, according to the provisions of the Rule and rules specific to them.

**Article 1.1.7. (1)** The criteria for the reaction to fire class shall be considered to be met if the performance actually achieved is equal to or greater than the minimum performance established by the Rule. Reaction classes to fire with cardinal numbers smaller than those indicated in the Rule or by a previous alphabet letter are permitted (e.g. if class **B-s3d1** are allowed, then classes **B-s3d0**, **B-s2d1**, **B-s2d0**, **B-s1d1**, **B-s1d0**, **A2-s1÷s3,d0÷d1** and **A1** are also allowed).

**(2)** The classification of the resistance to fire of a product for a given period of time includes all lower classes as follows:

- Classification **REI-M** of a product for a given period of time includes classifications **REI**, **RE**, **R** for the same period.
- Classification **REI** of a product for a given period of time includes classifications **RE**, **R** for the same period.
- Classification **EI-M** of a product for a given period of time includes classifications **EI** and **E** for the same period.
- Classification **EI** of a product for a given period of time includes the classification **E** for the same period.
- Requirement **I** of a product for a given period of time includes the

requirement **W** for the same period (requirement **W** of a product for a given period of time **does not** include the requirement **I** for the same period).

**Article 1.1.8. (1)** In order to meet the standardised conditions, criteria and levels of performance, construction materials, elements and products manufactured in the country or imported, complying with Government Decision No 668/2017 laying down conditions for the marketing of construction products shall be used. Construction materials, elements and products for which the manufacturer/importer/distributor declares ‘No Performance Determined (NPD)’ or ‘Open Description (OD)’ are not allowed. The reaction to fire of construction materials, elements and products shall be determined on the basis of applicable EU regulations, EU delegated regulations and EC decisions.

(2) As an alternative to the laboratory fire test method, the calculation procedures presented in Eurocodes may be used to assess the fire resistance performance criterion of building elements.

(3) Lightweight walls made up in dry assembly from thin boards (of plasterboard, glass fibre reinforced plaster, cement boards, etc.), with or without glazed elements, as well as walls made of other types of components (thermo-insulated corrugated plate panels, etc.) may be executed, based on technical approvals for lightweight wall systems or the European Technical Assessment for the placing on the market of construction products, where their resistance to fire is determined according to the applicable test standards for their reaction to fire classification.

(4) The reaction to fire class of gypsum plasterboard required in the Rule refers to the components of the wall (gypsum plates, uprights, beams, fasteners, internal insulations).

(5) Where conditions for fitting automatic sprinkler fire-extinguishing systems for construction, building or fire compartment are laid down in the Rule, these automatic installations shall be provided according to the provisions of the Rule **P118: 2** and/or **SR EN 12845** for all construction, building or fire compartment (except for high or very high buildings, in which case the fitting shall be made for the entire building), taking into account the spaces exempted from fitting and those protected by other compatible automatic extinguishing systems. No automatic sprinkler extinguishing systems shall be provided in cases where fire-extinguishing is ensured with automatic extinguishing systems with other substances referred to in Rule **P118:2** and/or **SR EN 12845**, as well as when water is not indicated as an extinguishing substance, in which case automatic extinguishing systems with other substances provided for according to **P118: 2** and/or **SR EN 12845** shall be fitted.

(6) Where conditions for fitting water fog systems (fixed fire extinguishing systems) are laid down in the Rules, they shall be provided only if and when tested according to the standards.

(7) Where throughout the Rule, conditions are provided for fitting water spray fire-extinguishing systems, they shall be provided according to the provisions of the Rule **P118: 2**.

**Article 1.1.9. (1)** The provisions of this Rule lay down the conditions and levels of performance specific to the fire safety of civil, production and/or storage constructions, or with mixed functions, of all categories of importance.

(2) New constructions classified in the categories of importance ‘**A**’ and ‘**B**’ must meet the criteria for classification in the level **I** or **II** of fire stability.

(3) For constructions classified in the categories of importance ‘**A**’ and ‘**B**’, except in the case of historic or architectural monuments classified according to the law in which the provisions of **Article 1.1.5.** are complied with, additional fire safety measures as determined by the designer shall be taken..

**Article 1.1.10. (1)** The reaction to fire conditions and the fire safety measures provided by the main materials, products and components of construction and installations used in the design and execution of the constructions shall be laid down in the technical documentation drawn up by the relevant specialist designers responsible for the measures taken, as follows:

a) architects, for: conformity and fire correlation of the construction, partitioning elements, external perimeter and roof closures, partitions, escape routes for users, protection

of functional gaps for circulation and communication in walls and floors, thermal, acoustic (sound) treatments, waterproofing, finishes (interior and exterior) including cladding used, compliance of access routes for intervention vehicles (number of access to facades, minimum width of road access, connection radii, etc.);

**b)** civil engineers, for: ensuring the resistance to fire of components which contribute to the fire stability of the construction (pillars, bearing walls, floors, roofs, stairways, balconies, passageways, etc.), passive protection of metal, concrete, wooden structures, etc., as well as for specifying the critical temperature of the metal structures for which protections to heat from fires must be ensured, based on calculations drawn up according to the Eurocodes;

**c)** installer engineers specialising in construction installations for designed systems, equipment and installations, namely: sanitary, gas, electrical, automation, ventilation, air-conditioning, refrigeration, heating and fire protection, such as those for detection, signalling and alarm, for extinguishing with water or other special substances, for exhausting of smoke and hot gases through natural draught or mechanical ventilation, for detecting flammable gases, etc.

**(2)** Responsibility for the veracity of the data provided to designers lies with:

**a)** technology engineers for determining the fire risks associated with technological processes and for risk mitigation/control measures;

**b)** investors for determining and presenting the nature and quantities of maximum allowed mobile combustible materials to be used, handled and stored in the constructions to be designed.

**Article 1.1.11.** In this Technical Rule, the following terms are used to indicate the degree of obligation associated with the provisions:

**a)** ‘is mandatory’, ‘is necessary’, ‘must’ (modal use of ‘shall’ with other verbs, e.g. ‘height must be ...’) indicates the strict obligation to comply with the provisions in question;

**b)** ‘as a rule’ indicates that this provision must be applied in most cases; failure to comply with such a provision is permitted but must be duly justified in the project;

**c)** the words ‘is allowed’ indicate a satisfactory solution that may be applied in particular cases; it is compulsory to justify this solution in the project;

**d)** ‘is recommended’ indicates a preferable solution to be considered when choosing the solution; failure to comply with such a provision need not be justified in the project;

**e)** the conjunction ‘and’ is used to connect two conditions which must be valid at the same time (equivalent to the operator AND);

**f)** the conjunction ‘or’ (and its equivalents) is used to connect two conditions that can be valid at the same time or alternatively (equivalent to operator OR);

**g)** the noun ‘example’ or its abbreviation ‘e.g.’ is used to indicate one or more possibilities for the sole purpose of indicating practical applications of a rule or principle. **Examples and drawings (figures) should be considered indicative, non-exhaustive cases provided as illustration only.**

## SECTION II

### 1.2. Terminology, classifications

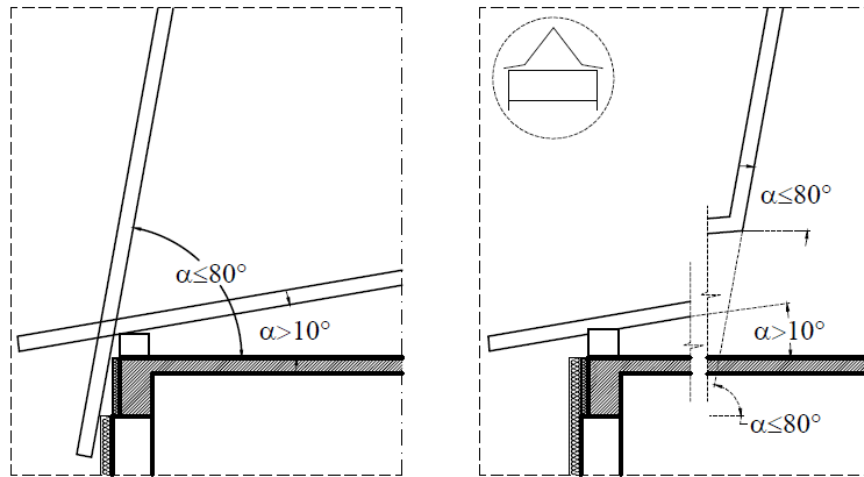
**Article 1.2.1.** For the purposes of this Rule, the terminology and classifications used have the following meanings:

**1) Roof** – part of the construction which closes the construction from the outside above

the last built level, consisting of structural and non-structural building elements and components. It may be sloping (roof framing type or terrace.)

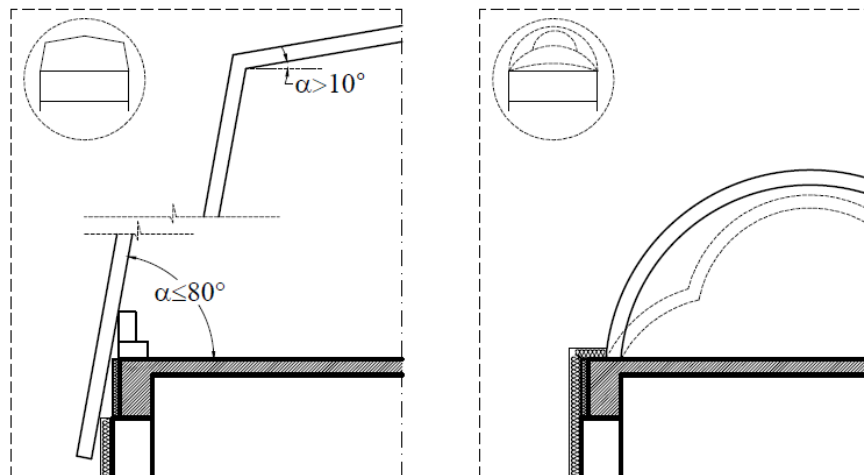
- a) **Sloping roof (roof framing type)** – roof where the gradient of the roof relative to its horizontal projection forms an alpha ( $\alpha$ ) angle. Roofs with a small slope (referred to as ‘flat roofs\*’) are deemed to be roofs having an angle ( $\alpha$ ),  $\alpha \leq 10^\circ$ , roofs with a large slope are deemed to be roofs having an angle  $10^\circ < \alpha \leq 80^\circ$ , as well as those with a curved surface. The slope of a roof/hip of a roof is determined by the line of the largest slope. Surface types – slopes can be:
- with flat surface
    - continuous, in a single plane according to Figure 1 variant a)
    - discontinuous
      - with slope break according to Figure 1 variant b) or level break
      - with level and slope break according to Figure 1 variant d)
    - with curved surface (single curvature according to Figure 1 variant c) or double curvature).

**Note:** Where sloping roofs represent flat roofs (inclination up to  $10^\circ$ ), they must be tested horizontally. Test results obtained with an inclination of  $0^\circ$  (horizontally) may be valid for flat roofs (with an inclination up to  $10^\circ$ ).



**Variant a)** – with continuous flat surface, in a single plane

**Variant b)** – with a discontinuous flat surface, with slope break



**Variant c)** – with a discontinuous flat surface, with level and slope break

**Variant d)** – with curved surface

**Figure 1 – Types of sloping roofs**

- b) **Terrace roof (floor type)** – horizontal or inclined building element which closes the

construction at the top, above the last built level, which must be fitted with carrying capacity **R** (its ability to withstand fire exposure on one or more sides during the standardised time under specified mechanical actions without loss of structural stability). Any roof (floor type) with a reinforced or prestressed concrete/monolithic or prefabricated reinforced concrete structure, with a slope small or equal to  $10^{\circ}$ , is considered to meet this provision. The terrace roof designed for various functions such as car parks, commerce, etc. must comply with the design requirements specific to the developed function and the type of building.

Notes: 1. For load-bearing floors and roofs without fire separation function (tested and classified for fire applied only from below in exceptional cases, where a floor or a roof is exposed to fire simultaneously on both sides, shall be tested as a balcony/passageway), the performance criterion is the load-bearing capacity and is defined by the class **R**. For floors and roofs with a fire separation function (tested and classified for fire applied only from below), the performance criteria are the load-bearing capacity and fire-tightness or the load-bearing capacity, fire tightness and thermal insulation, defined by the class **RE** or **REI**.

2. Where photovoltaic devices are applied over the final waterproofing layer, the provisions of **Table 2, reference number 10 (b)** or **Table 3 reference number 10 (b)** shall be taken into account.

3. In the situation of positioning the thermal insulation between the reinforced concrete floor and a layer of slope concrete of minimum **3,00 cm**, the use of materials is permitted according to the provisions of **Article 2.3.6.2.1. 4.**

**c) Green roof** – as defined in the Guide on the design and execution of green roofs in new and existing buildings, reference number GP 120 of 21.11.2013

**2) Building envelope** – The building's perimeter closure construction assembly, consisting of facades, regardless of the materials and construction system, as well as a covering system

**3) Burning** – exothermic reaction of a substance with an oxidiser. Burning generally emits fire effluents accompanied by flames and/or incandescence.

a. **Oxidation** – chemical reaction in which the proportion of oxygen or other electronegative element in a substance is increased.

b. **Oxidiser** – substance likely to produce an oxidation reaction. Burning is an oxidation.

**4) Built area (Ac)** – the area of the horizontal section of the building, at  $\pm 0.00$  elevation, of the ground floor, measured according to **STAS 4908** – Non industrial, industrial and agricultural buildings. Conventional areas and volumes

Note: The following are considered:

**a) Built area** – the area of the horizontal section of the building, at  $\pm 0.000$  elevation of the ground floor, measured on the outer contour of the walls (or the projection on the ground of the contour of the above-ground levels if their surface is larger).

Note:

(1) The built-up area does not include:

i. – jutties with an area less than **0.4 m** and oriels with an area larger than **0.4 m<sup>2</sup>**;

ii. – external steps and uncovered terraces,

iii. – uncovered terraces of the ground floor beyond the plane of the façade, platforms, access ladders. Ground projection of balconies whose elevation mark is below **3.00 m** from the developed ground level and the enclosed loggia of the floors are included in the built area.

iv. – areas of internal, exterior glass-roofed courts or access courts (commonly known as English courts) larger than **4 m<sup>2</sup>**

(2) For underground buildings and basements, the built-up area shall be measured at the final elevation of the floor coverings and shall be considered as the area of the horizontal section contained in the outer contour of the walls, including the thickness of the insulation protection wall. In the case of a construction located on a sloping terrain, the area of construction shall be calculated in horizontal planes in steps, depending on the terrain and the specific nature of the construction.

(3) Since construction elements arranged for access to buildings (external inclined planes, external staircase – external steps and uncovered terraces) are not included in the calculation of the built area of the construction, they are not required to meet the requirements for external escape staircase.

**b) The built area on the apartment** – according to **STAS 4908** ‘Non industrial, industrial and agricultural buildings. Conventional areas and volumes’

**c) Level area** – The area of the horizontal section of the building at that level bounded by its outer contour.

Note: The attic is not considered a floor. Mansards, mezzanines and intermediate floors (whose area exceeds 40 % of that of the room in which they are made) shall be considered as floors (levels).

The level area shall be measured at **1 m** above the finished floor coverings.

The level area also includes intermediate level areas or internal or external annexes such as:

- areas of walkable terraces for different functions;
- loggia and interior balconies areas (in the case of theatres, cinemas, recitation rooms, or the like);
- areas of the intermediate floors (whose area is less than or equal to 40 % of that of the room in which they are made);
- balcony and loggia areas;
- areas of the walking porticoes and gangways where they are not more than one floor height, shall be deemed to relate only to the first level served;
- the area of the outer corridors;
- the area of external access ladders between levels is included in the calculation of the area of the level served;
- the area of rooms with a clear height of more than 1.80 m (e.g. basement, lift engine rooms, pumps, etc., protuberant parts and closed for the lighting of the basements, rooms in the mansards, etc.);
- areas of external ramps and access ladders from storage rooms, warehouses, etc.;
- dormer windows area in the case of mansards if height  $h \geq 1.80$  m.

The level area does not include:

- domes with areas of less than **4 m<sup>2</sup>** and depth less than **2 m**, ornamental profiles and cornices;
- coatings, non-walkable (retracted) terraces above the next lower level;
- gaps larger than **4 m<sup>2</sup>**, each of them only in glass-roofed courts and English courts;
- areas referred to in the definition of ‘built-up area’, paragraph (1);
- dormer windows area in the case of mansards, if height **h < 1.80 m**

In buildings, except dwellings, which have portions with a different number of levels or disparate levels of equal or different heights served by the same staircase, the number of levels shall be determined according to the figures in **STAS 4908** ‘Non industrial, industrial and agricultural buildings. Conventional areas and volumes’

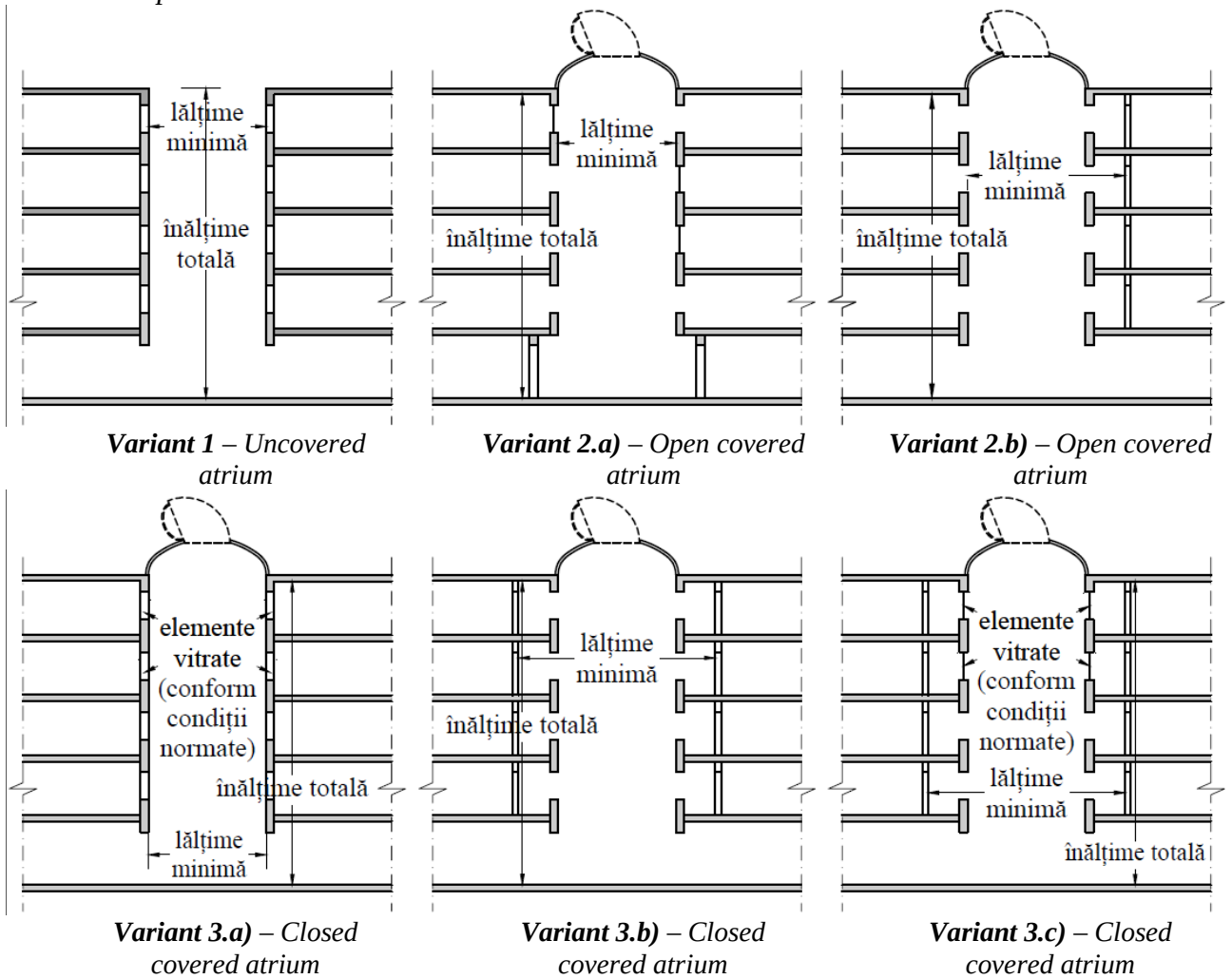
**d) Wall area, Useful area, Useful area of the apartment** – according to **STAS 4908** ‘Non industrial, industrial and agricultural buildings. Conventional areas and volumes’

**5) Developed area, built up area (in dwellings)** – according to **STAS 4908** ‘Non industrial, industrial and agricultural buildings. Conventional areas and volumes’

Note: specific fire safety measures shall be provided, including on the surface of the basements of clear height from **1.80 m** up to **2.10 m**, on the surface of the basements used strictly for car parking, technical areas or balconies, loggia, open and uncovered terraces provided for escape, as well as the separation of (non-serviceable) attics from spaces used, as well as external stairways.

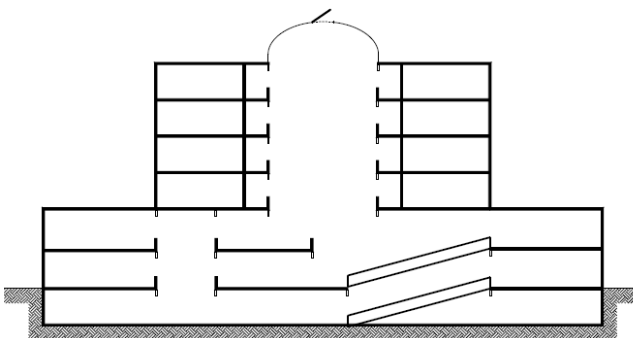


6) **Atrium** – the free volume inside a building or the volume generated by several buildings, bounded on one or more sides by at least four levels of the building and which do not need to be vertically aligned. Atriums can be uncovered, covered or covered open (as shown in Figure 2 and Figure 3). For more information see **Annex** ‘Constructive compositions – atriums’

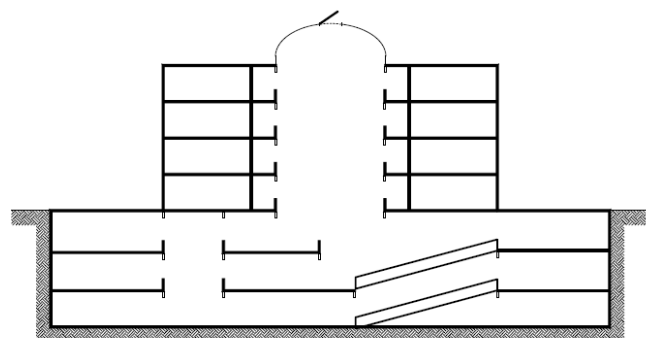


**Figure 2 - Types of atriums**

lățime minimă	minimum width
înălțime totală	overall height
înălțime totală	overall height
elemente vitrate (conform condiții normate)	glazed elements (under standardised conditions)



**Variant a) – Correct variant**



**Variant b) – Incorrect variant**

### Figure 3 – Underground interconnected atrium

Notes to **Figure 3**: The entire surface of the above-ground part of the space interconnected through the atrium is open and unobstructed so that a fire in any part of the space interconnected through the atrium will be easily visible to the users of the space before it becomes a danger to them.

A single underground level interconnected with the above-ground part of the construction, interconnected through the atrium, is accepted, (**Figure 3 variant a**).

In order to mitigate the consequences of the panic effect, for atrium buildings whose maximum capacity is greater than **1 500** persons, the number of flows for which escape to the outside the building must be ensured through the external doors that also constitute access routinely used by the public or visitors (persons outside the building) must be increased by multiplying it with a coefficient of minimum **1.25**.

**7) Escape route** – functional (horizontal or vertical) common path embedded in or attached to the construction, intended to evacuate users in the event of fire, separated from the rest of the construction with fire resistant elements. Free paths (without obstacles) which, fulfilling the conditions laid down in this Rule, ensure escape through doors, corridors, protected communication spaces, tunnels, halls or changing rooms, etc., at the level of walkable terrain or road surfaces or to adjacent fire compartments (under the conditions permitted by the Rule) shall be regarded as escape routes, as follows: directly; through escape staircases; through terraces, courts, loggia, escape passages.

Escape routes in the event of fire may be:

- common horizontal or vertical common path embodied in or attached to the construction and separated from the rest of it through elements with resistance performance and reaction to fire class
- specially designed escape routes which are only foreseen when the functional ones are insufficient or cannot satisfy the safety conditions for fire, separated from the rest of the construction with elements with performance in terms of resistance and reaction to fire class.

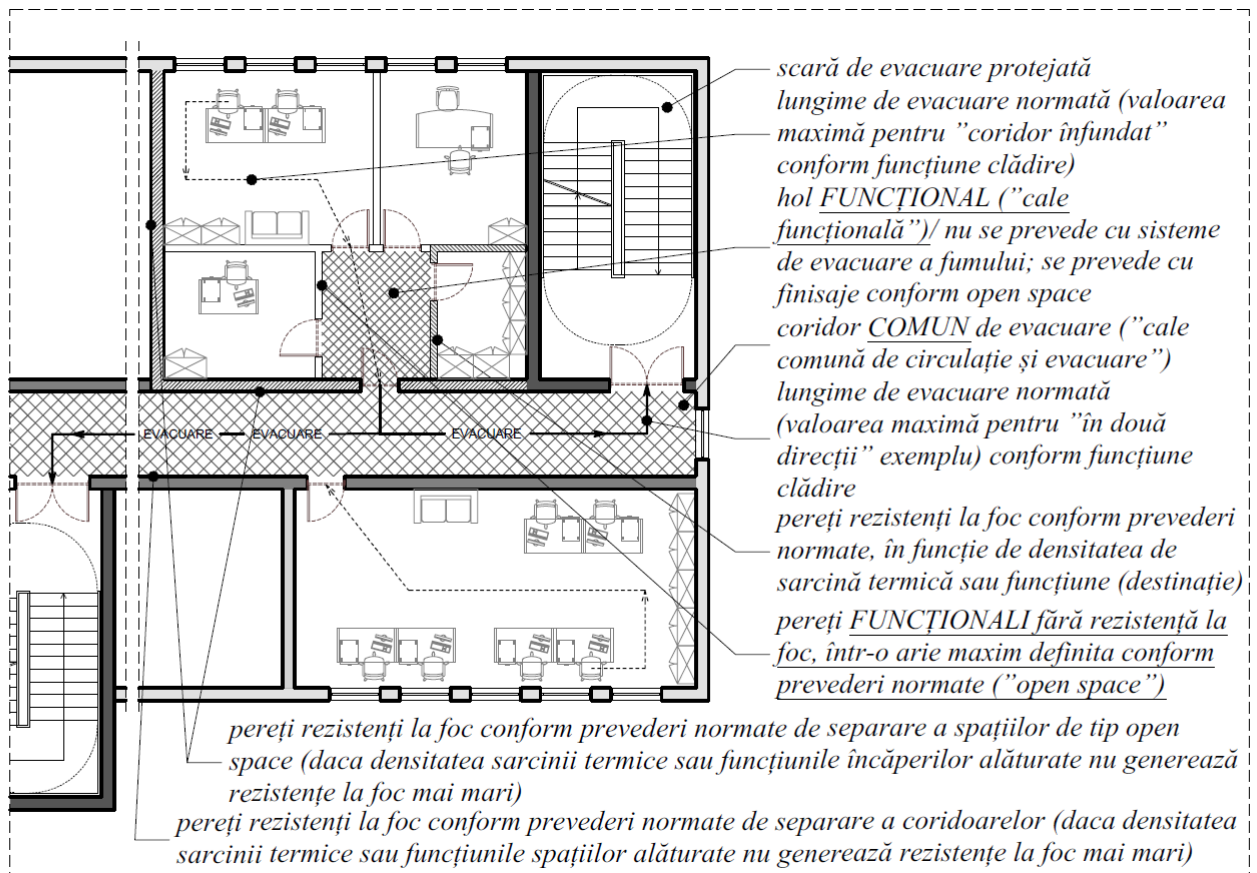


Figure 4 - Escape paths

scară de evacuare protejată lungime de evacuare normată (valoarea maximă pentru "coridor înfundat" conform funcțiune clădire)	protected exhaust staircase with standardised escape length (maximum value for 'dead-end corridor' according to the building function)
hol <u>FUNCTIONAL</u> ("cale funcțională ") nu se prevede cu sisteme de evacuare a f onului; se prevede cu finisaje conform open space	<u>FUNCTIONAL</u> hallway ('functional path') shall not be fitted with smoke exhaust systems; it is provided with finishes according to open space
coridor COMUN de evacuare ('cale comună de circulație și evacuare") lungime de evacuare normată (valoarea maximă pentru "în două direcții" exemplu) conform funcțiune clădire	COMMON escape corridor ('common movement and escape route') with standardised escape length (maximum value for 'in two directions' example) according to the building function
pereți rezistenți la foc conform prevederi - normate, în funcție de densitatea de sarcină termică sau funcțiune (destinație)	fire resistant walls according to the provisions – standardised, depending on the density of thermal load or function (destination)
pereți <u>FUNCTIONALI</u> fără rezistență la -foc; într-o arie maxim definită conform prevederi normate ("open space")	<u>FUNCTIONAL</u> walls without resistance to – fire; within a defined maximum area according to standardised provisions ('open space')
pereți rezistenți la foc conform prevederi normate de separare a spațiilor de tip open space (daca densitatea sarcinii termice sau funcțiunile încăperilor alăturate nu generează rezistențe la foc mai mari)	fire resistant walls according to standardised open space separation provisions (if the thermal load density or the functions of adjacent rooms do not generate higher fire resistance)
pereți rezistenți la foc conform prevederi normate de separare a coridoarelor (daca densitatea sarcinii termice sau funcțiunile spațiilor alăturate nu generează rezistențe la foc mai mari)	fire resistant walls according to standardised corridor separation provisions (if the thermal load density or the functions of adjacent spaces do not generate higher fire resistance)

*Note **Figure 4:** The grouping of open space spaces with a low fire risk and the same purpose divided by parapets, opaque or glazed panels, fixed or mobile, used as functional separations, including collateral destinations, including those of horizontal functional communications, shall be permitted. The grouping of open space rooms shall be partitioned at the boundary against the common escape paths (corridors, protected communication spaces, buffer rooms, enclosed staircases etc.), as well as against the spaces with different fire risk (from thermal load density and/or operation), with fire resistant walls specific to open space type of spaces or according to the provisions of the adjacent spaces (the most restrictive requirements must be chosen) according to the classification of each function or type of construction. Within the grouping of open space spaces, rooms with a different fire risk (from thermal load density and/or operation) shall be partitioned by fire resistant walls specific to these rooms. Functional communication between open space spaces and horizontal common paths may be done through common spaces belonging to open space which must meet the specific conditions of open space type of spaces.*

**8) Access, intervention and rescue routes/paths** - access, intervention and rescue routes, suitably constituted, sized and marked so that they can be used by personnel intervening in the event of fire.

Access, intervention and rescue routes are:

- c) Exterior – for easy access to fire-fighter intervention vehicles, being marked and kept free at all times. As a rule, the intervention to at least at one facade of the building shall be ensured, except in the cases specified in the Rule.
- d) Interior – for easy access to the main functional paths (horizontal and vertical), as well as to spaces with risk or fire hazard.

**9) Internal paths** – horizontal/functional horizontal paths intended for use in a room.

**10) Smoke control ducts** – ducts used in a system to control the movement and/or retention of smoke and heat

**Smoke exhaust ducts from a single compartment** – smoke control ducts designed to provide a degree of fire resistance for use in a single compartment

**Fire resistant multi-compartment smoke exhaust ducts** – smoke control duct designed to provide a degree of fire resistance for use in more than one compartment.

**Smoke control flap** – device that can be opened or closed to control the flow of smoke and hot gases

**Note 1:** In the fire operating position, the smoke control flap may be opened (to evacuate smoke from the burned compartment) or closed (to avoid the spread of smoke to other areas).

**Note 2:** Classifications refer to the term ‘compartment’ representing an enclosed space, comprising one or more separate spaces, limited by components of construction having a specified fire resistance, to prevent the propagation of fire in any direction for a given period of time. The term in this sense will refer strictly to the classifications of those products.

**Smoke screen (smoke barrier)** – device designed to channel, retain and/or prevent smoke migration, used to limit and/or prevent the spread of smoke, classified **DH** or **D<sub>600</sub>**

Note: Smoke barriers are also referred to as smoke curtains, smoke blinds or smoke screens.

**Note:** Alternatively to the provisions of this Rule, the screen height of smoke and hot gas exhaust systems (for non-standard structures or buildings where large dimensions, shape or configuration make it necessary to control smoke and/or according to design criteria, or at the request of the competent authorities, appropriate performance levels regarding the smoke-free air layer height, air bed temperature, external influences, etc.) may be different, but not less than **50 cm**.

**Smoke and heat exhaust escape fan** – device specially designed to exhaust smoke and hot gases from a construction under fire conditions

**Smoke and heat natural exhaust fan (smoke exhaust hatch)** – device specially designed to remove smoke and hot gases from construction works through the floatation force

**Natural ventilation** – ventilation caused by upward forces resulting from differences in density between smoke and ambient air gases due to temperature differences

**Geometrical area** – the area of a section through a fan, measured in the plane defined by the building surface that is in contact with the fan structure

Note: The geometric area is expressed as **Av**. No reduction shall be made for guide paths, ventilation gaps or other obstructions.

**Mechanical ventilation** – ventilation that is caused by the application of an external energy to move the gas through a fan.

**11) i) Corridor** (passageway) – long and narrow transit room (with a length at least double the width);

**ii) Hall** (changing room) – transit room which does not meet the corridor conditions.

**12) Reaction to fire class** – quantitative expression, expressed in terms of performance, for the behaviour of a product under end-use conditions, which, by its own decomposition, feeds a fire to which it is exposed; it is expressed by the level of the specific parameters determined by standardised tests. The structuring into performance levels of reaction to fire classes is established by the Regulation on the classification and qualifying the construction products based on reaction to fire performance. In this Rule, the minimum reaction to fire class means a minimum performance criterion for the class **A÷F**, minimum for smoke emissions **s1 s2** and **s3** and minimum for drops **d0 d1** and **d2**. Example: minimum **C-s2d0** means that this class or any class of reaction to fire above it is allowed only for smoke emissions **s1** and **s2**, and for drops only **d0**;

Where ‘minimum’ or ‘at least’ is stated in the Rule, they shall refer to each of the components of the indication (letters and suffixes).

**13) Classes of reaction to fire performance of construction products**

**(13.1)** Classes of reaction to fire performance of construction products (excluding floor coverings, thermal insulation products for linear tubing and electric cables), are **A1, A2, B, C, D, E and F**, namely:

1. **A1** – non-combustible products which do not contribute at all to the

- development of the fire;
2. *A2* – products which cannot ignite by flame and whose contribution to the development of the fire is extremely limited;
  3. *B* – products that are extinguished in the absence of a maintenance flame and whose contribution to the development of the fire is very small;
  4. *C* – combustible products which contribute to the development of fire within certain limits;
  5. *D* – combustible products that contribute to the development and spread of fire;
  6. *E* – combustible products whose contribution to the rapid spread of the fire is important;
  7. *F* – combustible products whose contribution to the rapid spread of fire is very important.

For each product, the emission of smoke (*s1*, *s2* and *s3*) and burning drops/particles (*d0*, *d1* and *d2*) shall be specified, according to ‘Regulation on the classification and qualifying of construction products based on reaction to fire performance’

**(13.2)** The classes of reaction to fire performance of building floors are: *A1<sub>FL</sub>*, *A2<sub>FL</sub>*, *B<sub>FL</sub>*, *C<sub>FL</sub>*, *D<sub>FL</sub>*, *E<sub>FL</sub>* and *F<sub>FL</sub>*, with smoke emission specification (*s1* or *s2*).

**(13.3)** The classes of reaction to fire performance of thermal insulation products for linear tubing are: *A1<sub>L</sub>*, *A2<sub>L</sub>*, *B<sub>L</sub>*, *C<sub>L</sub>*, *D<sub>L</sub>*, *E<sub>L</sub>* and *F<sub>L</sub>* with smoke emission (*s1*, *s2* and *s3*) and burning drops/particles specification (*d0*, *d1* and *d2*).

**(13.4)** The reaction to fire classes of electric cables are: *A<sub>ca</sub>*, *B1<sub>ca</sub>*, *B2<sub>ca</sub>*, *C<sub>ca</sub>*, *D<sub>ca</sub>*, *E<sub>ca</sub>* and *F<sub>ca</sub>*, with smoke emission (*s1*, *s1a*, *s1b*, *s2* or *s3*) and burning drops/particles (*d0*, *d1* or *d2*) and a conductivity specification (*a1*, *a2* or *a3*).

**14) Civil building** – construction intended for users, with the exception of those intended for production and/or storage activities and those agrozootechnical; in the context of this Rule, **building types** (buildings of normal height, high buildings, underground buildings, very high buildings and buildings with crowded rooms) are defined.

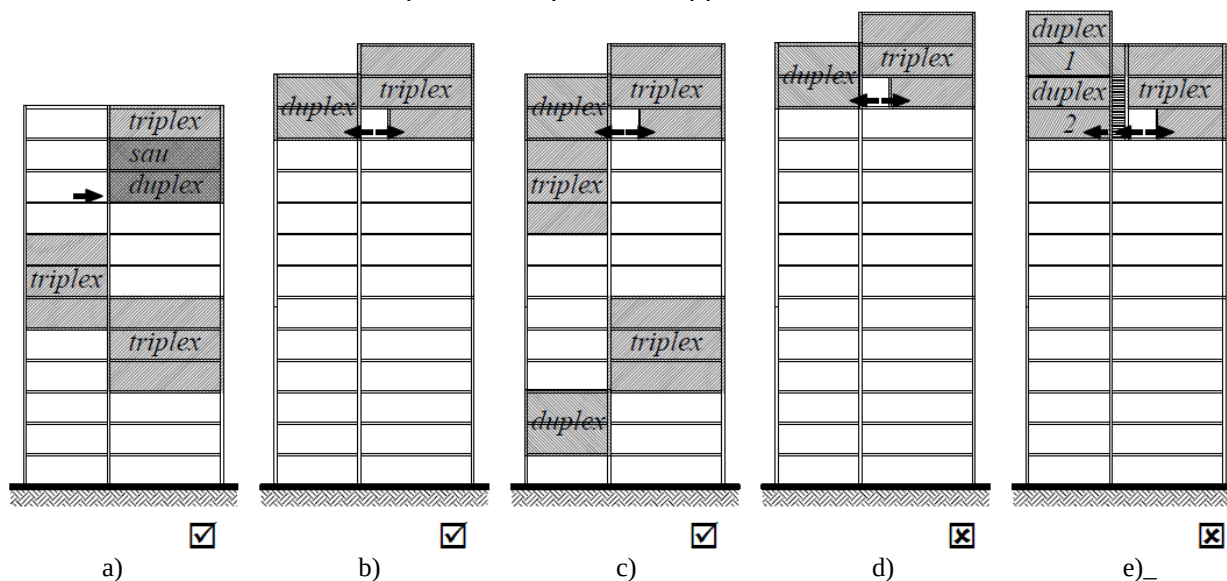
**15) High building** – above-ground civil (public) building, where the upper part of the wear layer of the last level floor used by users is more than 28 m and less than 45 m above the reference level (**28 m < h < 45 m**). High buildings must allow emergency services vehicles to fully access at least two (2) adjacent sides and at the same time, at least on 50 % from the perimeter of the external walls. The height of the buildings at which the terrace roof is designed for various functions such as car parks, commerce, etc. account shall be taken of the rate of circulation of the trafficable terrace relative to the reference level.

a. Are not considered as high buildings (according to Figure 5):

1. – constructions for production and/or storage;
2. – multi-dwelling buildings with maximum 12 above-ground levels, with the exception of mixed-function civil buildings where the function of collective dwelling has a developed area larger than 75 % of that of the building under review;
3. – where duplex or triplex dwellings are at the last levels, only the level of access to them from the common horizontal paths of the building shall be taken into account when determining the height of the construction, level of access which leads to classification as high building or as building of normal height. It is permissible for a single level to be a duplex or triplex type with

access according to the preceding paragraph, the two duplex levels or the three triplex levels being considered as one level, representing the last level of the construction. If the levels of access to duplex or triplex type dwellings are at levels other than that specified above, all levels of the duplex or triplex dwellings shall be taken into account when determining the height of the construction.

4. – civil buildings (regardless of destination), where there is a single built level above the standard limit level occupying maximum 50 % of the built-up area of the lower level and comprises only technical spaces related to the building (lift rooms, thermal power stations, ventilation plants, etc.), functional and escape routes (halls, corridors, buffer rooms ventilated in excess pressure etc.) or appended spaces (laundry rooms, ironing rooms, dryers rooms, etc.), without the permanent presence of persons.



triplex	triplex
sau	or
duplex	duplex

**Correct variant**  
12 levels-a)


**Correct variant**  
12 levels-b)

**Correct variant**  
12 levels-c)

**Incorrect variant**  
13 levels-d)

**Incorrect variant**  
14 levels-e)

LEGENDĂ

 - nivel de acces

LEGENDĂ	LEGEND
Nivel de acces	Level of access

**Figure 5 - Duplex or triplex dwellings in buildings of normal height**

**16) Very high building** – above-ground civil (public) building where the upper part of the floor wear layer of the last useable level is situated at the height of 45 m or more relative to the height of the reference level. Very high buildings must allow at least two emergency services vehicles to have access to minimum two (2) adjacent sides and at the same time, at least on 50 % of the perimeter of the external walls. Residential buildings where the floor of the last habitable level is situated above the height of over 50 m relative to the height of the reference level (according to the definition). The height of buildings

where the terrace roof is designed for various functions such as car parks, commerce, etc. shall be determined taking into account the rate of circulation of the trafficable terrace relative to the reference level.

The following are not considered very high buildings:

- a. – constructions for production and/or storage;
- b. – civil buildings (regardless of destination), where there is a single built level above the standard limit level occupying maximum **50 %** of the built-up area of the lower level and comprises only technical spaces relating to the building (lift rooms, thermal power stations, ventilation plants, etc.), functional and escape paths (halls, corridors, buffer rooms ventilated in excess pressure, etc.) or appended areas (laundry rooms, ironing rooms, dryers rooms, etc.), without the permanent presence of persons.

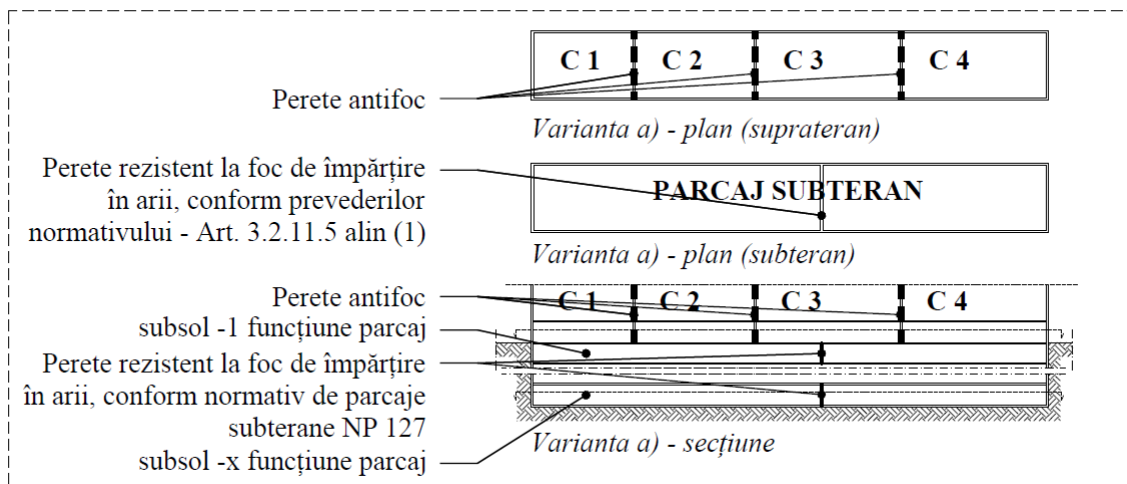
**17) Building of normal height** – above-ground civil building that is not a high or very high building.

**18) Mixed-function building** – construction comprising different main civil-civil or civil-production and/or storage or production-storage functions.

**19) Agrozootechnical building** construction intended for the various production processes in the livestock (stables and housing for animals and birds) and agricultural and plant sectors (seedlings, greenhouses, forage factories, wineries, winemaking sections, etc.). This category includes construction ancillary to production: grain stores for animal feed, forage silos, garages, sheds, workshops, etc.

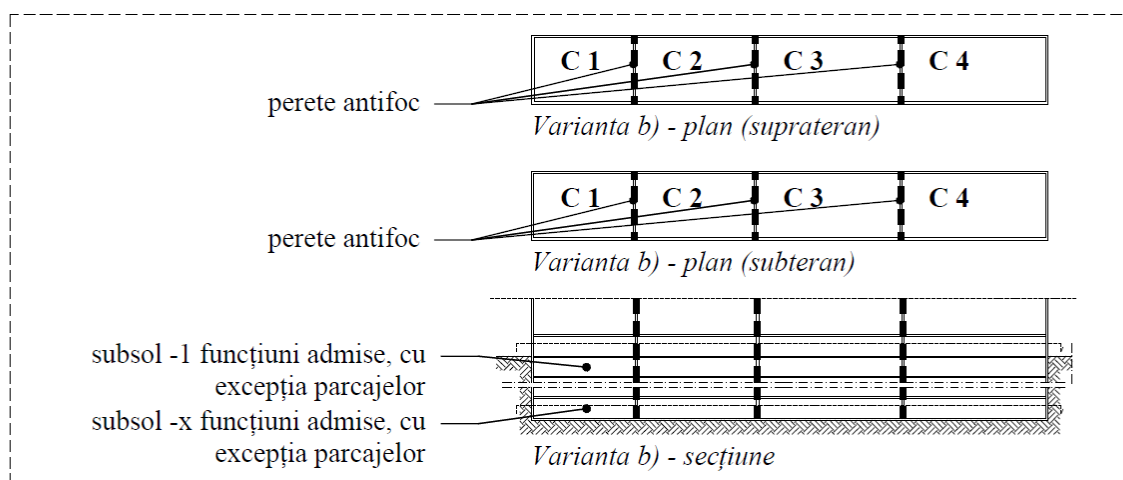
**20) Fire compartment** – may consist of:

- a. independent construction, located at safe distances from adjacent buildings;
  - b. part of a high or very high building bounded by resisting/fire resistant walls and/or floors separating the fire compartments (fire bulkheads and fire floors) from the rest of the construction;
  - c. group of constructions pooled within built-up areas (**Ac**) maximum standardised; within such a group, the constructions may be located at distances shorter than the normal safety distances and may be delimited between them only by the fire resistant partitions required within the fire compartment; a group of buildings constituting a fire compartment shall, however, be positioned from other buildings at normal safety distances, or be delimited from them by fire resistant partitions separating the fire compartments;
- 1) High or very high buildings may be subdivided in maximum three volumetric portions of three levels each with the total area deployed (**Ad**) not exceeding **3,500 m<sup>2</sup>** (with the exception of very high dwelling buildings where the specific provisions are complied with) and any number of compartments bounded by fire walls that divide the building fully vertically according to the regulatory provisions. Compartments consisting of volumetric portions shall consist of one to three levels successively constructed, bounded by fire resistant fire division separation floors (fire resistant floors) and, where applicable, fire resistant bulkheads (fire bulkheads), as described in Figure 8 and Figure 9.
  - 2) Underground buildings (and underground portions of above-ground buildings) excluding underground car parks (example: Figure 6) may be divided over their full height with fire resistant walls defining the fire compartments (in the same vertical plane), within the constructed area (**Ac**) not exceeding **3,500 m<sup>2</sup>** or may be subdivided into volumetric portions thereof with the total area developed (**Ad**) not exceeding **3,500 m<sup>2</sup>**, portions consisting of one to three successively constructed levels bounded by floors and, where appropriate, fire resistant bulkheads (fire resistant floors and fire walls).



Perete antifoc	Fire wall
Perete rezistent la foc de împărțire - în arii, conform prevederilor normativului - Art. 3.2.11.5 alin (1)	Fire resistant wall divided in areas, according to the provisions of the legislation – Article 3.2.11.5(1)
Perete antifoc - subsol -1 funcțiune parcaj - Perete rezistent la foc de împărțire - în arii, conform normativ de parcaje subterane NP 127 subsol -x funcțiune parcaj	Fire protection bulkhead – 1 parking lot function Fire resistant wall divided in areas, according to regulations for underground parking lots NP 127 basement – x parking lot function
<i>Varianta a) - plan (snprateran)</i>	<i>Variant a) – (above-ground) plane</i>
<b>PARCAJ SUBTERAN</b>	<b>UNDERGROUND PARKING LOT</b>
<i>Varianta a) - plan (subteran)</i>	<i>Variant a) – (underground) plane</i>
<i>Varianta a) – secțiune</i>	<i>Variant a) – section</i>

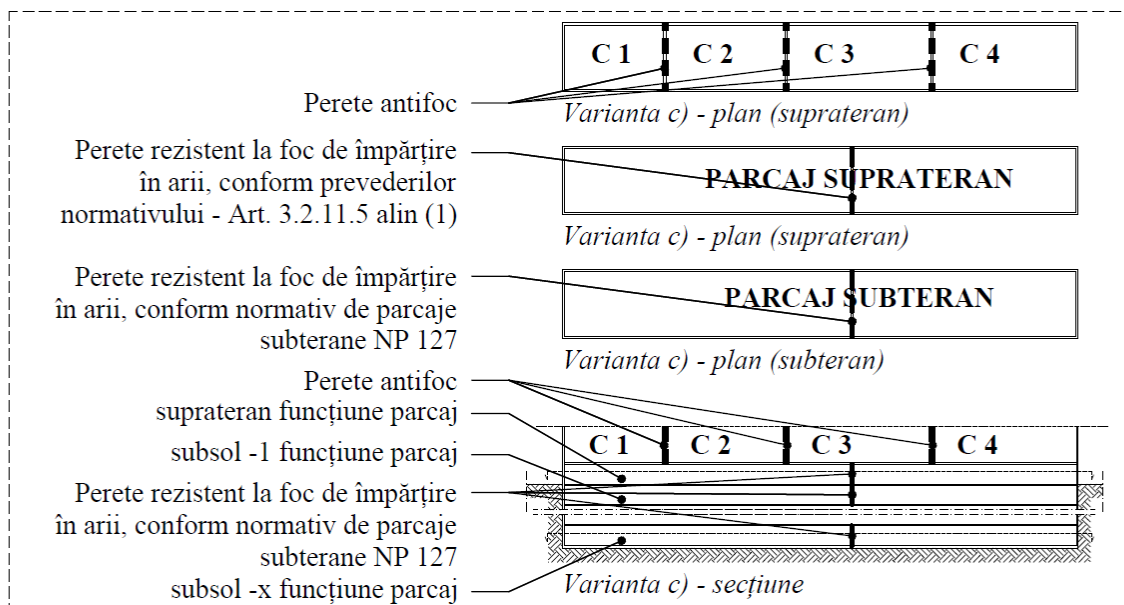
**Varianta a)** Fire divisions in civil buildings and fire compartments of normal height (level II fire stability) fitted with underground parking lot



perete antifoc	fire wall
subsol -1 funcțiuni admise, cu excepția parcajelor	basement – 1 permitted functions, with the exception of parking lots
subsol -x funcțiuni admise, cu excepția parcajelor	basement – x permitted functions, with the exception of parking lots
<i>Varianta b) - plan (snprateran)</i>	<i>Variant b) – (above-ground) plane</i>
<i>Varianta b) - plan (subteran)</i>	<i>Variant b) – (underground) plane</i>
<i>Varianta b) – secțiune</i>	<i>Variant b) – section</i>

**Varianta b)** Fire divisions in civil buildings and fire compartments of normal height (level II fire stability) not fitted with overground and/or underground parking lot



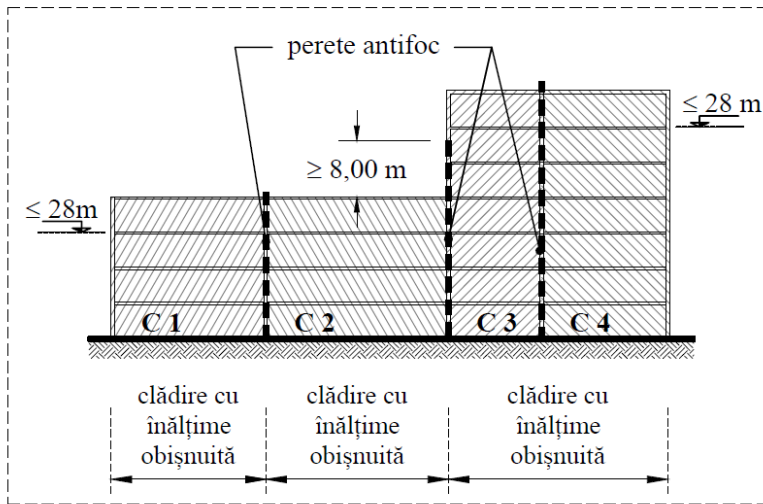


Perete antifoc	Fire wall
Perete rezistent la foc de împărțire în arii, conform prevederilor normativului - Art. 3.2.11.5 alin (1) i	Fire resistant wall in areas, according to the provisions of the legislation – Article 3.2.11.5 (1) i
Perete rezistent la foc de împărțire \ în arii, conform normativ de parcaje subterane NP 127	Fire-resistant partition wall \ in areas, according to the regulation of underground parking lots NP 127
Perete antifoc suprateran funcțiune parcaj subsol -1 funcțiune parcaj	Above-ground fire bulkhead function as an underground parking lot – 1 parking lot function
Perete rezistent la foc de împărțire în arii, conform normativ de parcaje i subterane NP 127	Fire resistant partition wall, according to the regulations for underground parking lots NP 127
subsol -x funcțiune parcaj	basement -x parking lot function
<i>Varianta c) -plan (suprateran)</i>	<i>Variant c) - (above-ground) plane</i>
<b>PARCAJ SUPRATERAN</b>	<b>ABOVE-GROUND PARKING LOT</b>
<i>Varianta c) - plan (suprateran)</i>	<i>Variant c) – (above-ground) plane</i>
<b>PARCAJ SUBTERAN</b>	<b>UNDERGROUND PARKING LOT</b>
<i>Varianta c) - plan (subteran)</i>	<i>Variant c) – (underground) plane</i>
<i>Varianta c) – secțiune</i>	<i>Variant c) – section</i>

**Varianta c)** Fire divisions in civil buildings and fire compartments of normal height (level II fire stability) fitted with above-ground and underground parking lot

**Figure 6– Above-ground and underground fire partition in civil buildings and fire partition of normal height (level II fire stability)**

- 3) Constructions may consist of more than one bonded, embedded or superimposed fire compartment under the conditions of the preceding paragraphs (for example: Figure 7, Figure 8 and Figure 9).



**Legend:**

**C1, C2, C3, C4 – separate fire compartments, level II fire stability**

Fire compartment areas:

Compartment C1 – Built area  $\leq 3,500 \text{ m}^2$

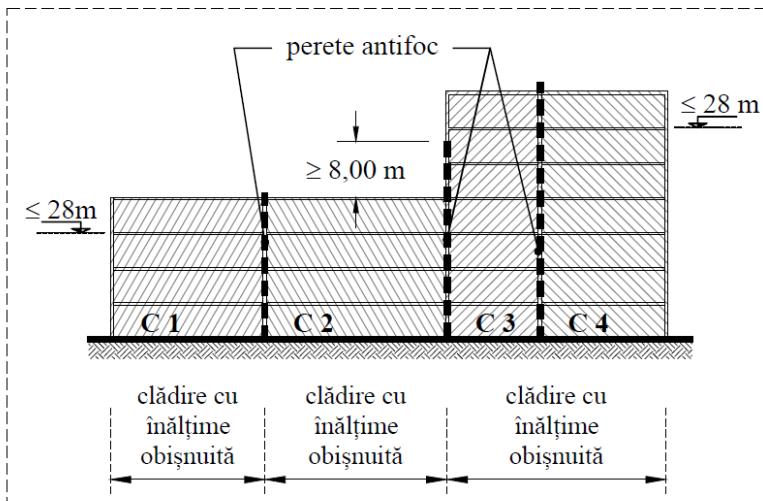
Compartment C2 – Built area  $\leq 3,500 \text{ m}^2$

Compartment C3 – Built area  $\leq 3,500 \text{ m}^2$

Compartment C4 – Built area  $\leq 3,500 \text{ m}^2$

perete antifoc	fire wall
clădire cu înălțime obișnuită	building of normal height

**Variant a) : not equipped with an automatic fire extinguishing system or fire detection, signalling and alarm system**



**Legend:**

**C1, C2 – separate fire compartments, level III fire stability**

**C3, C4 – separate fire compartments, level II fire stability**

Fire compartment areas:

Compartment C1 – Built area  $\leq 3,125 \text{ m}^2$

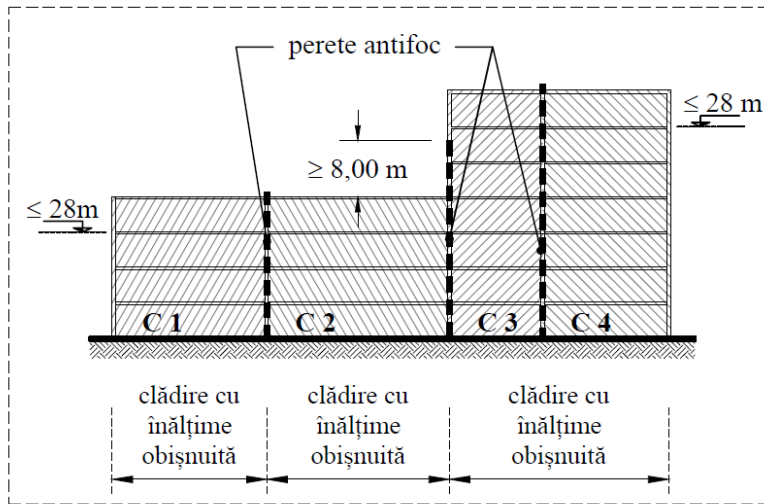
Compartment C2 – Built area  $\leq 3,125 \text{ m}^2$

Compartment C3 – Built area  $\leq 4,375 \text{ m}^2$

Compartment C4 – Built area  $\leq 4,375 \text{ m}^2$

perete antifoc	fire wall
clădire cu înălțime obișnuită	building of normal height

**Variant b) fitted with fire detection, signalling and alarm system with total coverage (all compartments are fitted with fire detection, signalling and alarm system with total coverage)**



**Legend:**

**C1, C2, C3, C4 – separate fire compartments, level III fire stability**

Fire compartment areas:

Compartment C1 – Built area  $\leq 5,000 \text{ m}^2$

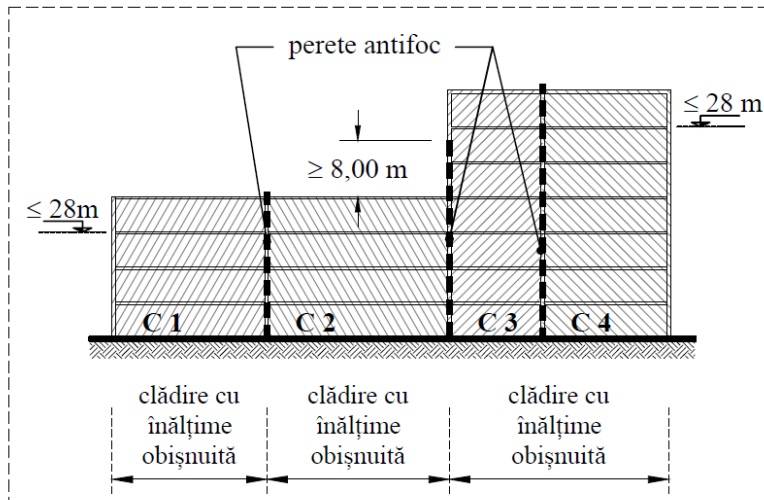
Compartment C2 – Built area  $\leq 5,000 \text{ m}^2$

Compartment C3 – Built area  $\leq 5,000 \text{ m}^2$

Compartment C4 – Built area  $\leq 5,000 \text{ m}^2$

perete antifoc	fire wall
clădire cu înălțime obișnuită	building of normal height

**Variant c) equipped with an automatic fire extinguishing system and automatic fire detection, signalling and alarm systems (all compartments are fitted with automatic fire detection, signalling and alarm systems with full cover and automatic fire-fighting installation)**



**Legend:**

**C1, C2 – separate fire compartments, level III fire stability**

**C3, C4 – separate fire compartments, level II fire stability**

Fire compartment areas:

Compartment C1 – Built area  $\leq 5,000 \text{ m}^2$

Compartment C2 – Built area  $\leq 5,000 \text{ m}^2$

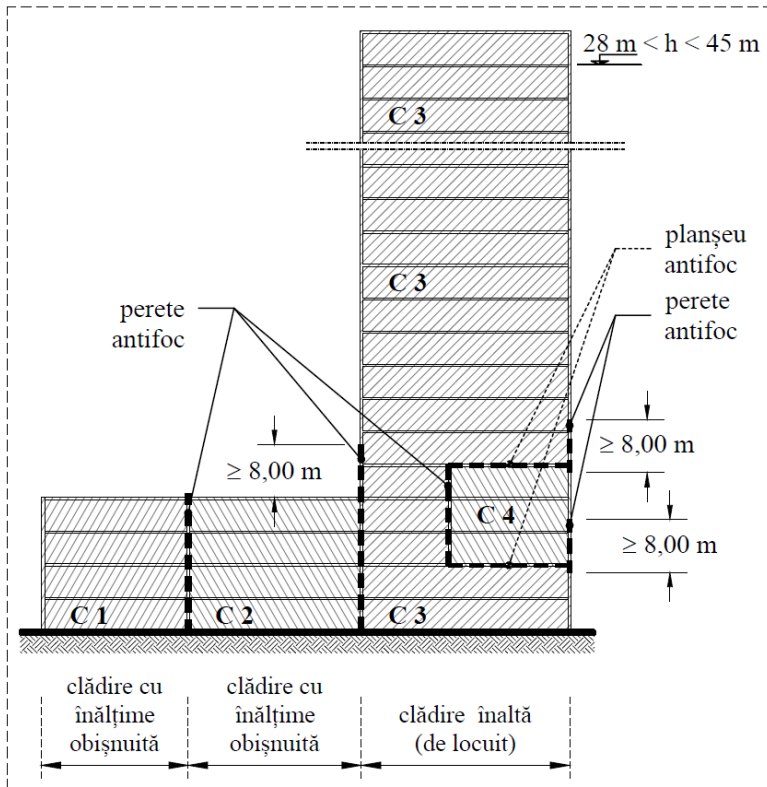
Compartment C3 – Built area – unlimited

Compartment C4 – Built area – unlimited

perete antifoc	fire wall
clădire cu înălțime obișnuită	building of normal height

**Variant d) equipped with automatic fire extinguishing system, fire detection, signalling and alarm systems with full cover and smoke exhaust installations from horizontal common paths (corridors/halls) and stairways (all compartments are fitted with these installations)**

**Figure 7 – Fire compartment and fire compartments areas in above-ground civil buildings and fire compartments of normal height**

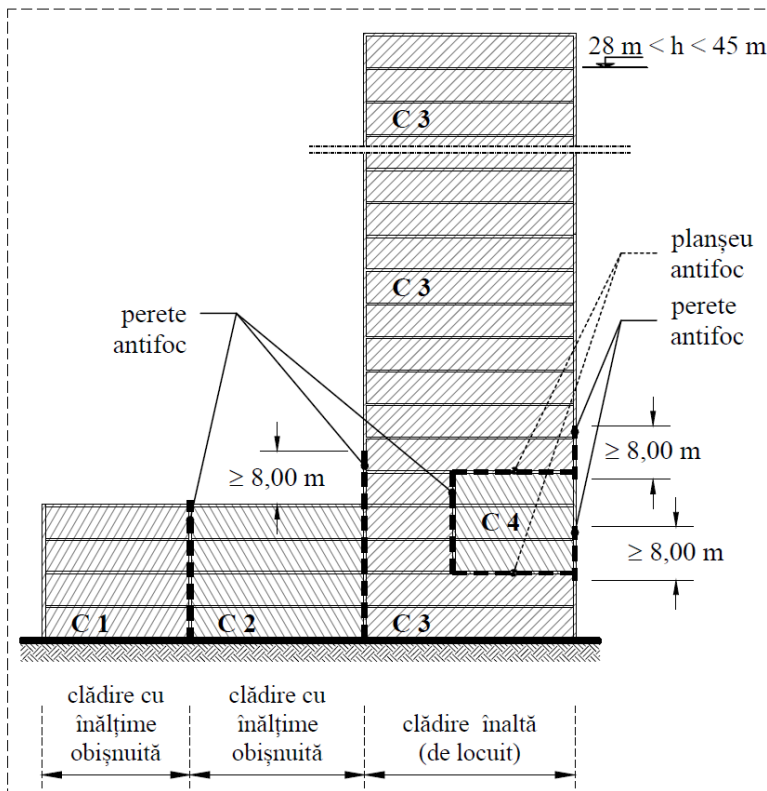


**Legend:**  
**C1, C2 – separate fire compartments, level I or II fire stability**  
**C3 – separate fire compartment in high building, level I fire stability**  
**C4 – separate volumetric fire compartment in the high building, level I fire stability**

**Fire compartment areas:**  
 Compartment C1 (building of normal height) – Built area  $\leq 3,500 \text{ m}^2$   
 Compartment C2 (building of normal height) – Built area  $\leq 3,500 \text{ m}^2$   
 Compartment C3 (high building) – Built area  $\leq 3,500 \text{ m}^2$   
 Compartment C4 (high building volumetric compartment) – Developed area  $\leq 2,500 \text{ m}^2$

perete antifoc	fire wall
clădire cu înălțime obișnuită	building of normal height
planșeu antifoc	fire floor
clădire înaltă (de locuit)	high (residential) building

**Variant a) buildings of normal height and high building with residential function, not equipped with an automatic fire extinguishing system or fire detection, signalling and alarm installations with total coverage**

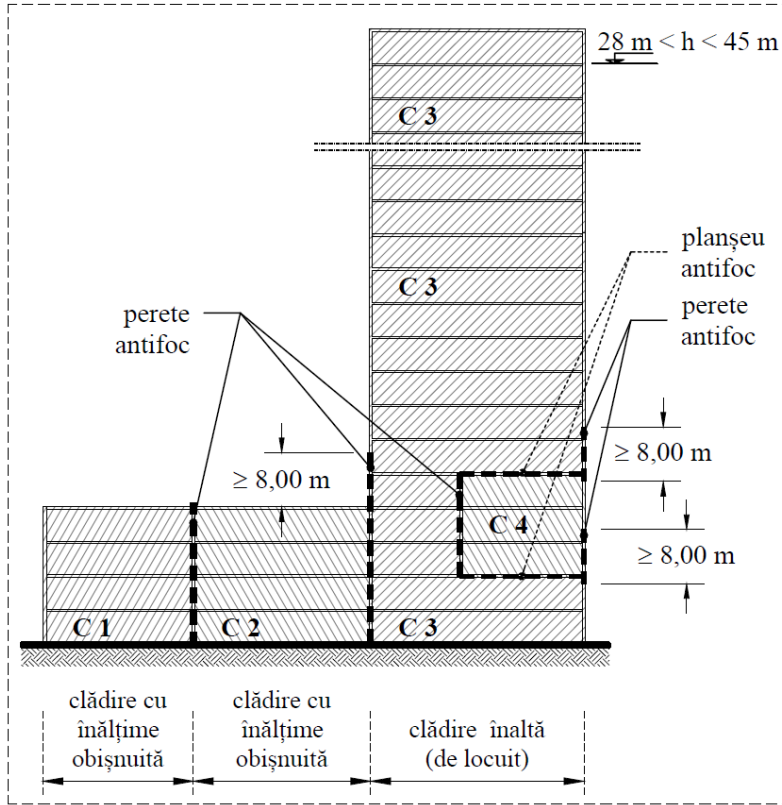


**Legend:**  
**C1, C2 – separate fire compartments, level I or II fire stability**  
**C3 – separate fire compartment in high building, level I fire stability**  
**C4 – separate volumetric fire compartment in the high building, level I fire stability**

**Fire compartment areas:**  
 Compartment C1 (building of normal height) – Built area  $\leq 4,375 \text{ m}^2$   
 Compartment C2 (building of normal height) – Built area  $\leq 4,375 \text{ m}^2$   
 Compartment C3 (high building) – Built area  $\leq 3,500 \text{ m}^2$   
 Compartment C4 (high building volumetric compartment) – Developed area  $\leq 3,500 \text{ m}^2$

perete antifoc	fire wall
clădire cu înălțime obișnuită	building of normal height
planșeu antifoc	fire floor
clădire înaltă (de locuit)	high (residential) building

**Variant b) buildings of normal height and high building with residential function, not equipped with an automatic fire extinguishing system (all compartments are equipped with fire detection, signalling and alarm systems with total coverage)**



**Legend:**

**C1, C2 – separate fire compartments, level I or II fire stability**

**C3 – separate fire compartment in high building, level I fire stability**

**C4 – separate volumetric fire compartment in the high building, level I fire stability**

*Fire compartment areas:*

*Compartment C1 (building of normal height) – Built area ≤ unlimited*

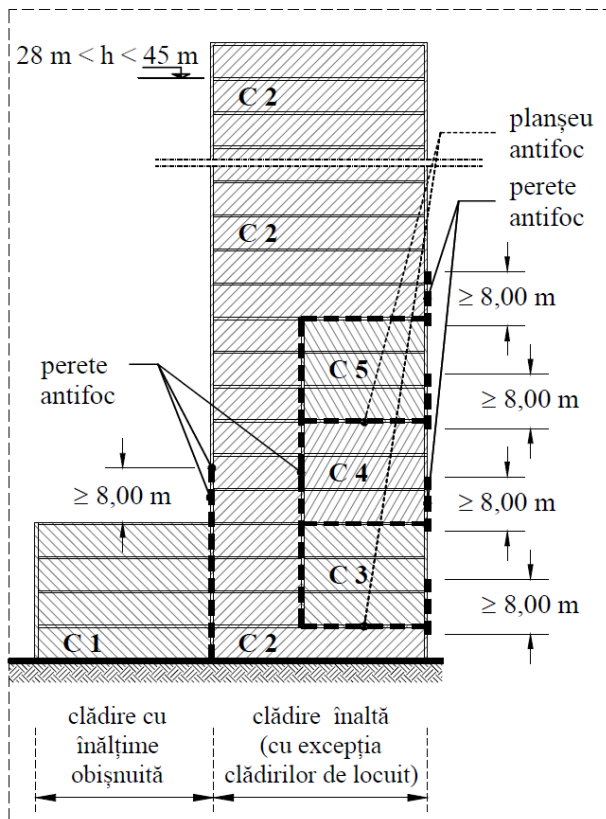
*Compartment C2 (building of normal height) – Built area ≤ unlimited*

*Compartment C3 (high building) – Built area ≤ 5,250 m<sup>2</sup>*

*Compartment C4 (high building volumetric compartment) – Developed area ≤ 3,500 m<sup>2</sup>*

perete antifoc	fire wall
clădire cu înălțime obișnuită	building of normal height
planșeu antifoc	fire floor
clădire înaltă (de locuit)	high (residential) building

**Variant c) buildings of normal height and high building with residential function equipped with automatic fire extinguishing system (all compartments are fitted with automatic fire extinguishing system, fire detection, signalling and alarm systems with full coverage, as well as smoke exhaust from horizontal common paths (corridors/halls) and staircases)**



**Legend:**

**C1 – separate fire compartment, level I or II fire stability**

**C2, C3, C4, C5 – separate fire compartments, level II fire stability**

Fire compartment areas:

Compartment C1 (building of normal height) – Built area ≤ unlimited

Compartment C2 (high building) – Built area ≤ 3,500 m<sup>2</sup>

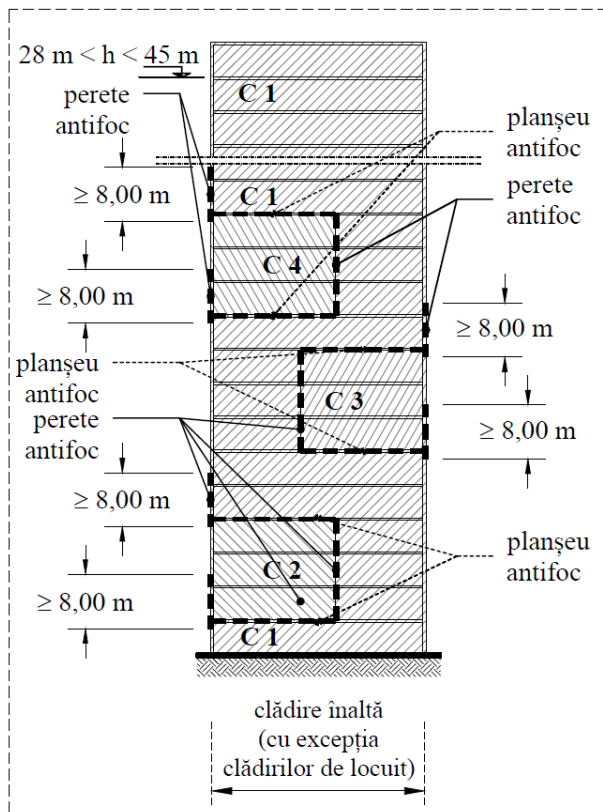
Compartment C3 (high building volumetric compartment) – Built area ≤ 3,500 m<sup>2</sup>

Compartment C4 (high building volumetric compartment) – Developed area ≤ 3,500 m<sup>2</sup>

Compartment C5 (high building volumetric compartment) – Developed area ≤ 3,500 m<sup>2</sup>

planșeu antifoc	fire floor
perete antifoc	fire wall
clădire cu înălțime obișnuită	building of normal height
clădire înaltă (cu excepția clădirilor de locuit)	high building (except for residential buildings)

**Variant d) building of normal height and high building except for the residential function, equipped with automatic fire extinguishing system (all compartments are fitted with automatic fire extinguishing system, fire detection, signalling and alarm systems with full coverage, as well as smoke exhaust from horizontal common paths (corridors/halls) and staircases)**



**Legend:**

**C1, C2, C3, C4 – separate fire compartments, level II fire stability**

Fire compartment areas:

Compartment C1 (high building) – Built area  $\leq 3,500 \text{ m}^2$

Compartment C2 (high volumetric building compartment) – Developed area  $\leq 3,500 \text{ m}^2$

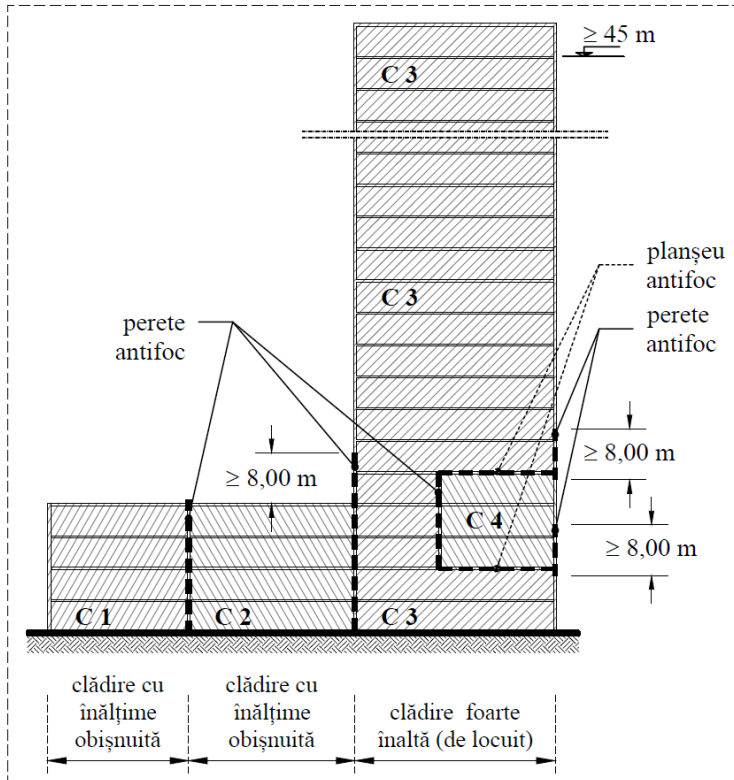
Compartment C3 (high building volumetric compartment) – Developed area  $\leq 3,500 \text{ m}^2$

Compartment C4 (high volumetric building compartment) – Developed area  $\leq 3,500 \text{ m}^2$

perete antifoc	fire wall
planșeu antifoc	fire floor
clădire înaltă (cu excepția clădirilor de locuit)	high building (except for residential buildings)

**variant e) high building with any function, except for the residential function, equipped with an automatic fire-extinguishing installation** (all compartments are fitted with automatic fire extinguishing system, fire detection, signalling and alarm systems with full cover, as well as smoke exhaust from horizontal common paths (corridors/halls) and staircases)

**Figure 8 – Fire compartment and fire compartments areas in above-ground high civil buildings and fire compartments**



**Legend:**

**C1, C2 – separate fire compartments, level I or II fire stability**

**C3, C4 – separate fire compartments, level I fire stability**

Fire compartment areas:

Compartment C1 (building of normal height) – Built area  $\leq 4,375 \text{ m}^2$

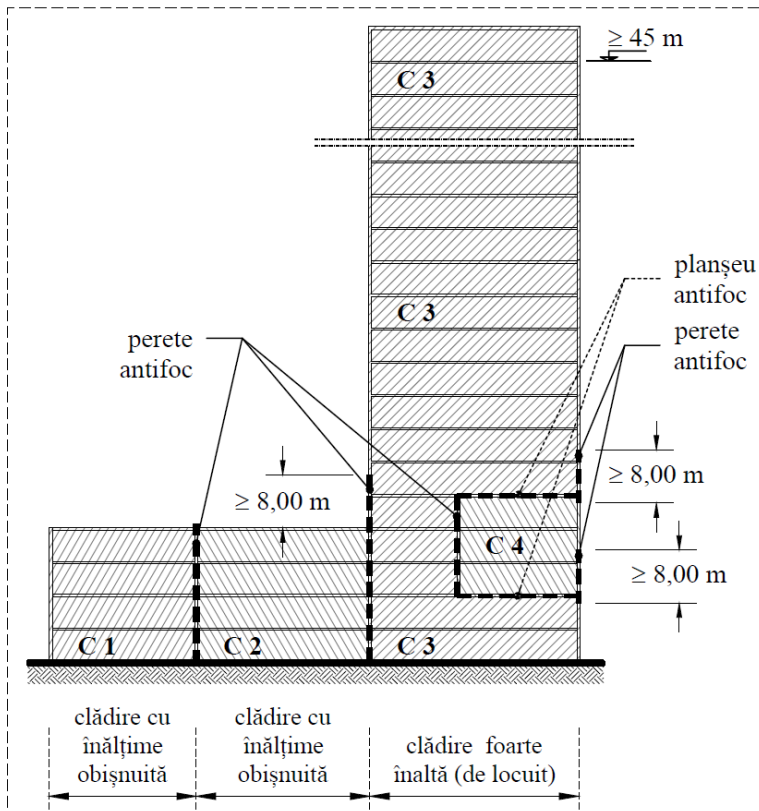
Compartment C2 (building of normal height) – Built area  $\leq 4,375 \text{ m}^2$

Compartment C3 (very high building) – Built area  $\leq 3,500 \text{ m}^2$

Compartment C4 (high building volumetric compartment) – Developed area  $\leq 2,500 \text{ m}^2$

planșeu antifoc	fire floor
perete antifoc	fire wall
clădire cu înălțime obișnuită	building of normal height
clădire foarte înaltă (de locuit)	very high (residential) building

**Variant a) building of normal height and very high building with residential function, not equipped with an automatic fire extinguishing system (all compartments are fitted with fire detection, signalling and alarm systems with total coverage)**



**Legend:**

**C1, C2 – separate fire compartments, level I or II fire stability**

**C3, C4 – separate fire compartments, level I fire stability**

Fire compartment areas:

Compartment C1 (building of normal height) – Built area  $\leq$  unlimited

Compartment C2 (building of normal height) – Built area  $\leq$  unlimited

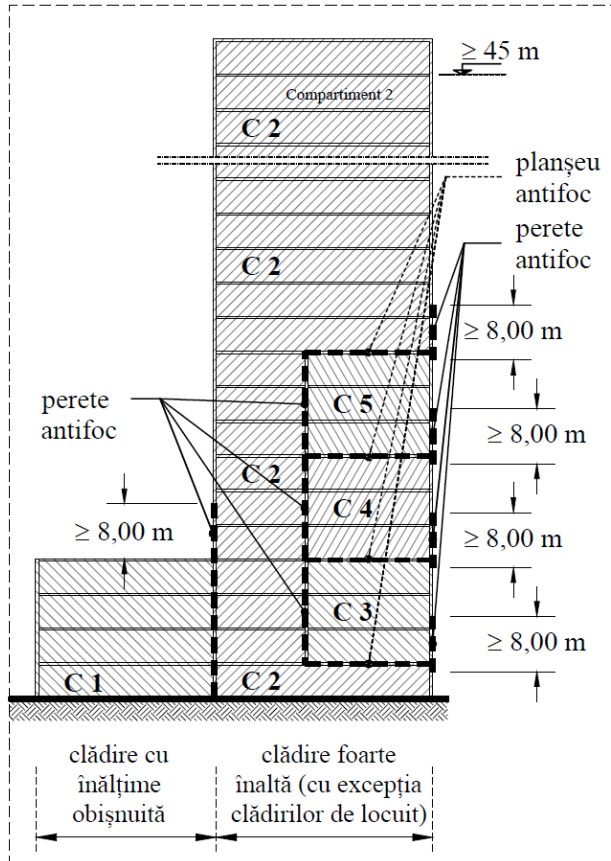
Compartment C3 (very high building) – Built area  $\leq 4,375 \text{ m}^2$

Compartment C4 (Very high building volumetric compartment) – Developed area  $\leq 3,500 \text{ m}^2$



planșeu antifoc	fire floor
perete antifoc	fire wall
clădire cu înălțime obișnuită	building of normal height
clădire foarte înaltă (de locuit)	very high (residential) building

**Variant b) building of normal height and very high building with residential operation equipped with automatic fire extinguishing system** (all compartments are fitted with automatic fire extinguishing system, fire detection, signalling and alarm systems with full coverage, as well as smoke exhaust from horizontal common paths (corridors/halls) and staircases)



**Legend:**

**C1 – separate fire compartment, level I or II fire stability**

**C2, C3, C4, C5 – separate fire compartments, level II fire stability**

**Fire compartment areas:**

Compartment C1 (building of normal height) – Built area ≤ unlimited

Compartment C2 (very high building) – Built area ≤ 3,500 m<sup>2</sup>

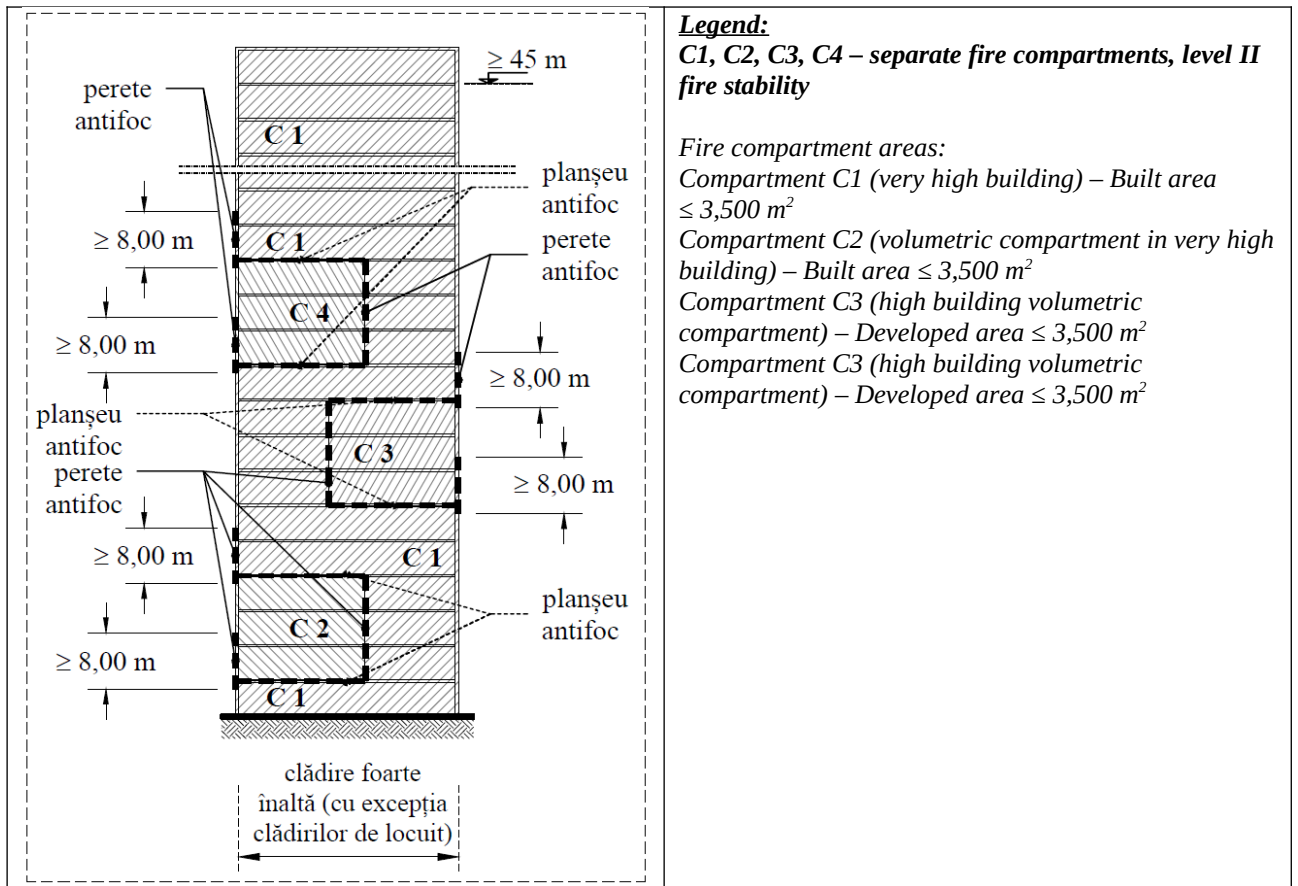
Compartment C3 (high building volumetric compartment) – Developed area ≤ 3,500 m<sup>2</sup>

Compartment C4 (Very high building volumetric compartment) – Developed area ≤ 3,500 m<sup>2</sup>

Compartment C5 (Very high building volumetric compartment) – Developed area ≤ 3,500 m<sup>2</sup>

**Variant c) building of normal height and very high building with any function, except for the residential function, equipped with an automatic fire extinguishing system** (all compartments are fitted with automatic fire extinguishing system and fire detection, signalling and alarm systems with full cover, as well as smoke exhaust system from horizontal common paths (corridors/hall) and staircases)

planșeu antifoc	fire floor
perete antifoc	fire wall
clădire cu înălțime obișnuită	building of normal height
clădire foarte înaltă (cu excepția clădirilor de locuit)	very high building (except for residential buildings)



planșeu antifoc	fire floor
perete antifoc	fire wall
clădire foarte înaltă (cu excepția clădirilor de locuit)	very high building (except for residential buildings)

**variant d) very high building with any operation, except accommodation, equipped with an automatic fire extinguishing system** (all compartments are fitted with automatic fire extinguishing system and fire detection, signalling and alarm systems with full cover, as well as smoke exhaust system from horizontal common paths (corridors/hall) and staircases)

**Figure 9 – Fire compartment and fire compartments areas in above-ground high civil buildings and fire compartments**

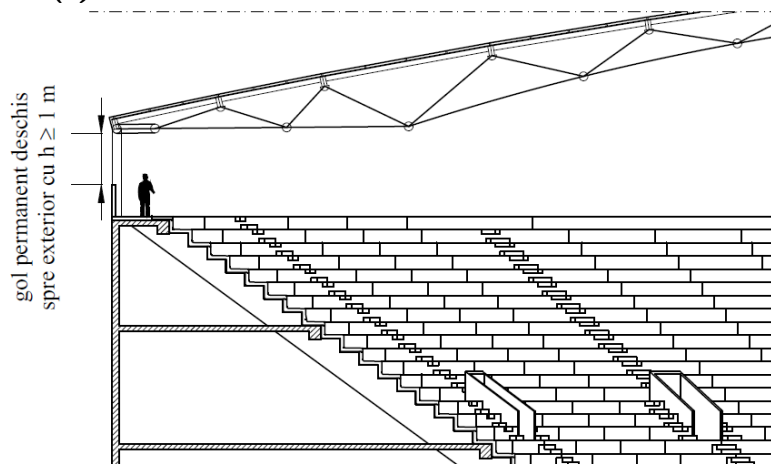
**21) Construction** – is the technical system defined by the constructional assembly and its associated utility installations, including the technical means to counter the fires envisaged; in the context of this legislation, the **'Categories of construction from the point of view of fire safety'** – buildings/constructions (civil, industrial, mixed), tents, outdoor platforms and open warehouses are defined.

- 1) **Closed construction** – above-ground/underground enclosed perimeter construction with walls that do not meet the criteria set out in **point 2) letter (ii)** and fitted with a roof
- 2) **Open construction** – above-ground/underground construction meeting one of the following conditions:
  - i. it is uncovered (without roof);
  - ii. covered construction with permanently open gaps on at least 50 % of the surface of the external walls.

Except in the case of spaces below the galleries, the stadiums covered are considered as open constructions if at the top (last level publicly accessible), gaps permanently open outwards are provided in perimeter closures with a minimum

height of at least **1 m** and their summed length is at least **75 %** perimeter (Figure 10).

Construction works which do not meet one of the criteria set out in **point (i)** and **point (ii)** are considered to be enclosed constructions.



gol permanent deschis spre exterior cu $h \geq 1$ m	permanently open outwards gap with $h \geq 1$ m
---	---

**Figure 10 – Covered stadium - open construction**

(‘gap’ figure = perimeter gaps permanently open outwards with a minimum height of **1 m** and their combined length of at least **75 %** of the perimeter)

- 3) **Construction/buildings intended for people who cannot evacuate themselves** are the following in the context of this Rule: pre-school children/pre-primary education buildings (0-3 years old) (crèches and children’s homes), healthcare facilities with continuous hospitalisation (defined according to the specialised legislation), nursing homes or homes for the elderly and disabled people, mental patients hospices, etc.).
- 22) **Underground construction** – independent construction entirely below the level of the surrounding land (natural or developed), having only pathways for access and escape to the ground level.
- 23) **Above-ground construction** – construction over and above the natural or improved surrounding land, with or without subsoil.
- 24) **Independent construction** – construction with its own foundation and structure.
- 25) **Tent** – construction where the structural shape of the membrane is provided by tensioned cables or load-bearing elements such as beams, poles or springs. To be considered a tent, the membrane must constitute at least **75 %** of the building envelope.
- 26) **Fire resistant safety curtain** – movable fire protection element in case of functional voids fire in walls delineating rooms, spaces or fire compartments.
- 27) **Performance criteria** – specific conditions in relation to which the fulfilment of a performance requirement is assessed. **Performance criteria** – for fire resistance are symbolised as follows:
  - R** – load-bearing capability (ability of the building element to withstand exposure to fire under specified mechanical action, on one or more faces, during the

standard time, under specified mechanical actions, without loss of structural stability);

**E** – fire tightness (the ability of a building element with a separating function to resist fire on one side without transmission of fire to the unexposed face as a result of the passage of flames or hot gases and which may cause the unexposed face or any material adjacent to this surface to ignite);

**I** - thermal isolation to fire (ability of the building element to resist fire exposure on one side only, without the propagation of fire as a result of significant heat transfer from the exposed face to the unexposed face. Propagation must be limited in such a way that neither the unexposed area nor any material in the immediate vicinity of that surface is ignited. The element must also provide a sufficient barrier against heat to protect people close to it. Where a building element has been assessed for different levels of corresponding thermal performance with several separate areas, the classification of the element as an assembly shall be given on the basis of the shortest time for which the maximum or average temperature rise criteria are met on any of the separate surfaces.);

Note (according to SR EN 13501-2):

*Thermal insulation of elements other than doors, shutters and closing assemblies of conveyor systems*

*For all separating elements except doors and shutters, the performance level used to define thermal insulation shall be the increase in the average unexposed face temperature limited to 140 °C above the initial average temperature, with the maximum temperature increase at any point limited to 180 °C above the initial average temperature.*

*For elements with small surfaces (such as joint seals), the concept of average temperature increase is irrelevant and thermal insulation is to be assessed only on the basis of the maximum temperature*

*Failure to meet any criterion of load-bearing capacity or fire tightness must also mean failure to comply with the thermal insulation criterion, regardless of whether or not the temperature limits of the specific thermal insulation have been exceeded.*

*Thermal insulation of doors and shutters*

*In the specific case of doors and shutters, one of the two options for the thermal insulation criterion shall be used:*

*- Thermal insulation I<sub>1</sub>*

*The average temperature increase on the unexposed face of the door wing must not exceed 140 °C above the initial average temperature, with the maximum temperature increase at any point in the door wing limited to 180 °C. No measurements of temperature shall be carried out on the door wing less than 25 mm from the boundary of the visible part of the door wing. Temperature increase at any point on the frame must not exceed 180 °C, measured 100 mm from the visible edge (on the unexposed face) of the door wing, if the frame is more than 100 mm wide, otherwise it shall be measured by placing the centre of the disc at 20 mm from the junction between the door frame and the supporting construction.*

*- Thermal insulation I<sub>2</sub>*

*The average temperature increase on the unexposed face of the door wing must not exceed 140 °C above the initial average temperature, with the maximum temperature increase at any point in the door wing limited to 180 °C. No measurements of temperature shall be carried out on the door wing less than 100 mm from the boundary of the visible part of the door wing. Temperature increase at any point on the frame must not exceed 360 °C, measured at 100 mm from the visible edge (on the unexposed face) of the door wing, if the frame is more than 100 mm wide, otherwise it shall be measured at the frame/supporting construction boundary.*

*The classification of thermal insulation must be specified using suffixes 1 and 2 which correspond to the above two definitions (e.g. I<sub>1</sub>). These suffixes shall only be used for fire resistant doors and shutters and closures for conveyor systems, but not for any other element of classification I.*

*Failure to meet the fire tightness criterion must also mean failure to meet the thermal insulation criterion, regardless of whether or not the temperature limits of the specific insulation have been exceeded.*

*Thermal insulation of conveyor closure assemblies*

In the specific case of conveyor closure assemblies, one of the three options of the thermal insulation criterion shall be used:

*Thermal insulation I<sub>1</sub>*

The average temperature increase on the unexposed face of the closure wing must not exceed 140 °C, above the initial average temperature, with the maximum temperature increase at any point in the closure wing limited to 180 °C. Temperature measurements shall not be carried out on the closure wing less than 25 mm from the boundary of the visible part of the closure wing. The temperature increase at any point on the frame/guide shall not exceed 180 °C, measured at 100 mm from the visible edge (on the unexposed face) of the closure wing, if the frame/guide is wider than 100 mm, otherwise it shall be measured at the boundary of the frame/supporting construction.

*Thermal insulation I<sub>2</sub>*

The average temperature increase on the unexposed face of the closure shall not exceed 140 °C above the initial average temperature, with the maximum temperature increase at any point in the closure wing limited to 180 °C. No measurements of temperature shall be carried out on the door wing less than 100 mm from the boundary of the visible part of the closure wing. The temperature increase at any point on the frame/guide shall not exceed 360 °C, measured at 100 mm from the visible edge (on the unexposed face) of the closure wing, if the frame is more than 100 mm wide, otherwise it shall be measured at the boundary of separation of the frame/supporting construction.

*Thermal insulation I*

In those cases where the specimen is a pipe configuration or pipe without any closure assessment for the conveyor system, a classification I<sub>1</sub> or I<sub>2</sub> is not possible. In this case, a classification I must be used.

When a test piece incorporates a conveyor closure together with a passage and its passing components, it shall result in a classification I allocated to the passing component or to sealing the intrusion. Complete closure assembly and transport system must however be classified using the appropriate index for I<sub>1</sub> or I<sub>2</sub> to distinguish between two possible routes for assessing closure for the transport system.

Failure to meet the fire tightness criterion must also mean failure to meet the thermal insulation criterion, regardless of whether or not the temperature limits of the specific insulation have been exceeded.

Specific classifications

Fire resistant doors and shutters

In the specific case of doors and shutters for the thermal insulation criterion, two different criteria are defined. Classification should therefore be made specifically by using one of the suffixes 1 or 2 to indicate the subclass.

When the test results and extended application results lead to a difference in the time of failure to comply with I<sub>1</sub> and I<sub>2</sub>, the element may have more than a classification. For example, a door that does not meet the first thermal insulation criterion after 50 min and the second after 70 min (E not being met after 95 min) shall be classified as EI<sub>1</sub>45/EI<sub>2</sub>60/E 90.

Where the difference in performance does not lead to a difference in classification, the element shall be classified with the suffix of the most severe requirement. Suffix 1 indicates here that the door also meets the second thermal insulation criterion. For example, a door that does not meet the first isolation criterion after 50 min and meets the second after 55 min (E not being met after 70 min) shall be classified as EI<sub>1</sub> 45/E 60.

Pass-through closures for conveyor systems

In the specific case of conveyor closure assemblies, three different levels are defined for the thermal insulation criterion. Classification must therefore be made specifically by using one of the suffixes 1 or 2, as appropriate, to indicate any subclass. For example, the complete conveyor closure assembly shall have one or more of the following classifications for different test pieces: EI<sub>1</sub> 45, EI<sub>2</sub> 60, EI 90, E 120. The principles of fire tightness classification in conveyor closure assemblies must also be applied.

**W** – thermal radiation (the ability of a building element to resist fire exposure on one side only, so as to reduce the possibility of spreading fire as a result of heat radiation either through the element or from the unexposed face to fire to materials adjacent to this surface/adjacent materials);

**M** – mechanical action (ability of a building element to withstand the impact of structural damage to another fire-exposed building element without compromising the performance of R, E and/or I);

**C** – self-closing is the ability of a protective element (door, open window, shutter, etc., as well as the closing element for open conveyor systems), to close completely into its frame (in its frame) and to operate any locking device without human intervention, by means of accumulated energy or by reproducing the accumulated energy in the event of interruption of the power supply. Index attached to the letter ‘C’ means the class of automatic self-closing/closing and shall be specified in the technical design documentation according to Table 1.

**Table 1: Self-closing class (automatic closing) of doors**

<b>Class</b>	<b>Degree of use</b>	<b>Cycles</b>
<b>C5</b>	frequent use;	≥ 200 000
<b>C4</b>	high frequency of use (public use without attention in use);	≥ 100 000
<b>C3</b>	average frequency of use (use by building staff);	≥ 50 000
<b>C2</b>	reduced frequency of use (from single-family dwellings to large industrial doors);	≥ 10 000
<b>C1</b>	frequency for doors in normal ‘open’ position;	≥ 500
<b>C0</b>	frequency for doors without defined performance (determined).	<b>from 1 until 499</b>

**S** – smoke tightness (ability of a building element to reduce or eliminate the passage of gases or smoke on one side on the other side). **S<sub>a</sub>** considers smoke sealing only at ambient temperature, and **S<sub>200</sub>** takes into account smoke tightness at both ambient temperature and at 200°C. In the case of smoke discharge tubing ‘S’ indicates a passing rate of less than 5 m<sup>3</sup>/(h·m<sup>2</sup>).

**Note (according to SR EN 13501-2):** For fire resistant elements, **S** must be added in the classification of resistance to fire (e.g. **EI<sub>2</sub> 60-S<sub>200</sub>**). Where the classification of resistance to fire is not relevant, the element shall simply be classified **S**. Classification **S** must be determined under ambient temperature conditions **S<sub>a</sub>** and/or medium temperature **S<sub>200</sub>** depending on the intended classification;

The following performance levels are defined:

— smoke tightness **S<sub>200</sub>** when the maximum leakage speed measured at both ambient temperature and at 200 °C and up to a pressure of 50 Pa shall not exceed 20 m<sup>3</sup>/h for a single door (single-side/wing), or 30 m<sup>3</sup>/h for a double door (with two parts/wings);

— smoke tightness **S<sub>a</sub>** when the maximum leakage speed measured only at ambient temperature up to a pressure of 25 Pa shall not exceed 3 m<sup>3</sup>/h per metre of the length of the gap between the fixed and movable components of the door set (e.g. between the sheet and the door frame), excluding the loss at the threshold.

**Note:** When **S<sub>200</sub>** is added to the normal requirements for fire-resistant building elements (e.g. **EI<sub>2</sub> 60-S<sub>200</sub>**) and this element of construction (e.g. door) is arranged between two differential pressurised spaces (e.g. between a protected clearance and a ventilated buffer room in excess pressure, smoke tightness **S<sub>a</sub>** may be used, respectively **EI<sub>2</sub> 60-S<sub>a</sub>** instead of **EI<sub>2</sub> 60-S<sub>200</sub>**).

**P** or **PH** (continuity of power supply and/or signal transmission during fire);

**G** – soot fire resistance (capacity of chimney and chimney products such as chimney sweeps and couplings to resist soot fire; includes aspects of smoke tightness and thermal insulation; classification **G** shall be accompanied by an indication of the necessary distance from products with a reaction to fire class other than **A1** under normal operating conditions);

**K** – fire protection capacity (ability of a wall or ceiling cover to provide for the undercover ignition protection, carbonisation or other damage protection, for a specified duration; coverings are the external parts of building elements such as walls, floors and roofs.);

**r** – if the performance against the exposure curve to a thermal attack of 500°C (low temperature exposure) instead of standardised exposure temperature/time, the classification of the element should thus be identified, e.g. **RE 30-r**.

**DH** – stability duration at the standard curve temperature – time.

**28) Protected clearance** – built-in closed space with a maximum length of 200 m intended for the **escape of users** in the event of fire, as well as for the intervention by firefighters, separately from the rest of the construction with **A1** or **A2-s1d0** elements (fire resistant **walls, floors** and **doors** compliant the regulatory provisions) and provided with excess pressure according to the provisions of the legislation, so made up, constructed and equipped as not to be flooded with smoke and affected by temperature within a standardised time. Protected clearance shall not be taken in consideration in the calculation of the length of the escape route

1. **Escape tunnel** – protected clearance directly exiting to the terrain or external road surfaces. The escape tunnel shall not be taken in consideration in the calculation of the escape route length;

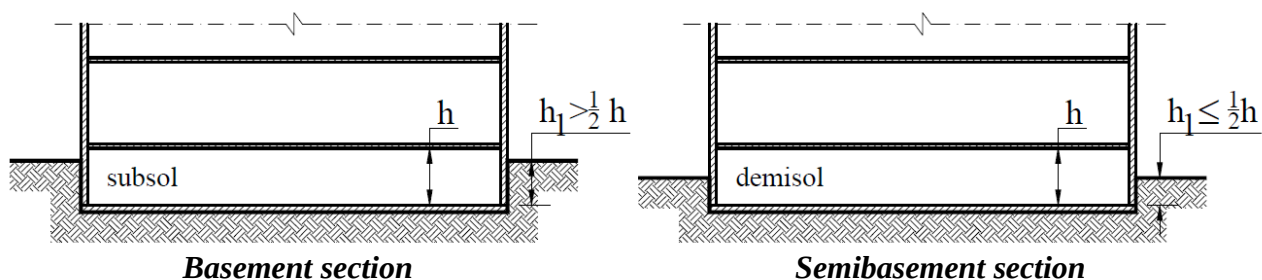
**29) Heat load density (q)** – total calorific potential of a room, space, fire compartment or construction in relation to the floor area considered (thermal load per unit area), expressed in MJ/m<sup>2</sup>. The determination of the heat load density shall be carried out according to **SR 10903-2 Fire protection. Determination of fire load in buildings**.

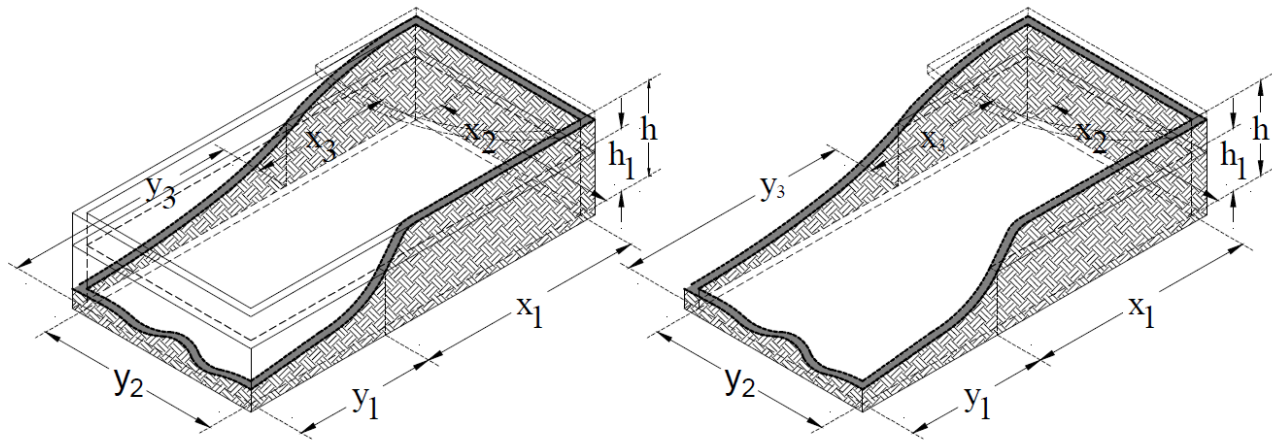
1. **Heat load** the amount of heat that can be produced by the fully burning of all combustible materials contained in a space, including the finishes of all lateral surfaces. In the Rule context, the term is used to refer to energy. It is expressed in kJ or MJ.

**30) Semibasement** – a constructed level of the construction with the floor below the level of the terrain (roadway) adjacent to not more than half its clear height.

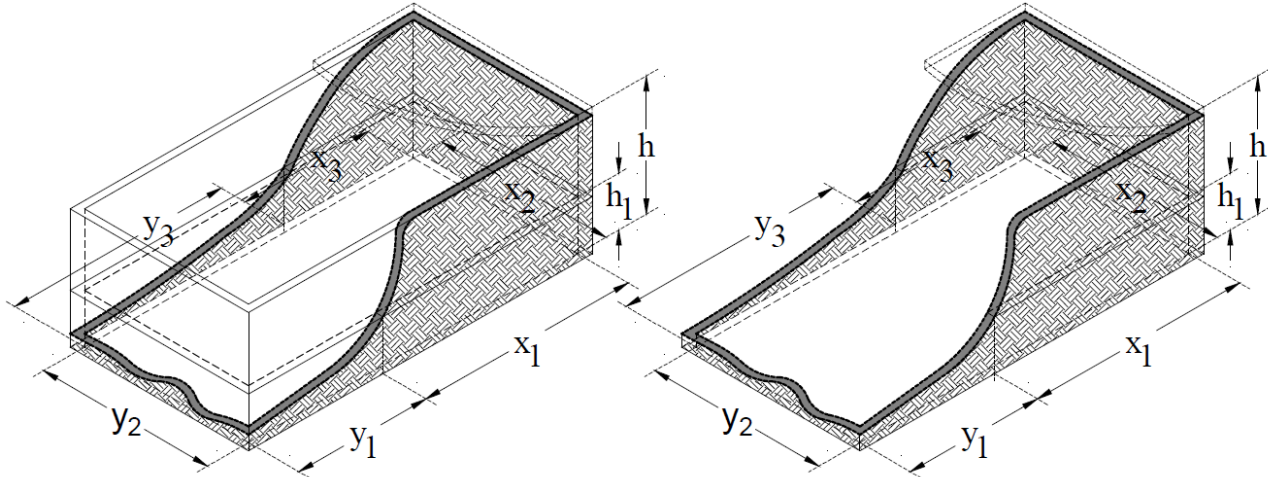
1. **Semibasement** shall be deemed to be **above-ground level** of the construction when its floor is situated below the surrounding terrain (roadway), with  $h_1 \leq \frac{1}{2} h$  located below the ground level and included in the number of above-ground levels. On sloping land, semibasement is considered to be an above-ground level when the above-ground condition on **50 % or more** of the perimeter is met (Figure 11). Common semibasement paths with technical functions, without natural light and ventilation, shall not be provided with smoke and hot gas exhaust systems in the event of fire

2. **Basement** – a constructed level of the construction with the floor below the level of the land (roadway) adjacent to more than half its clear height. Basements shall be included in the number of underground construction levels.





**Basement perspective geometry**



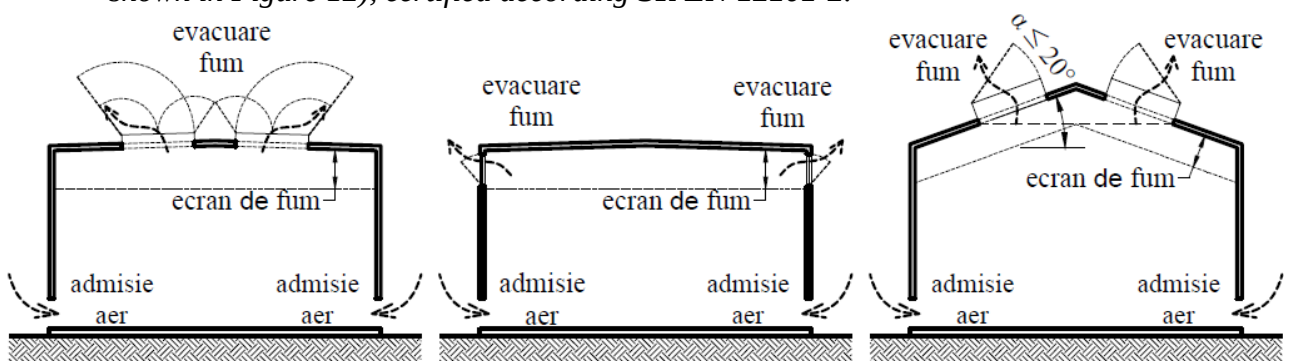
**Semibasement perspective geometry**

subsol	basement
demisol	semibasement

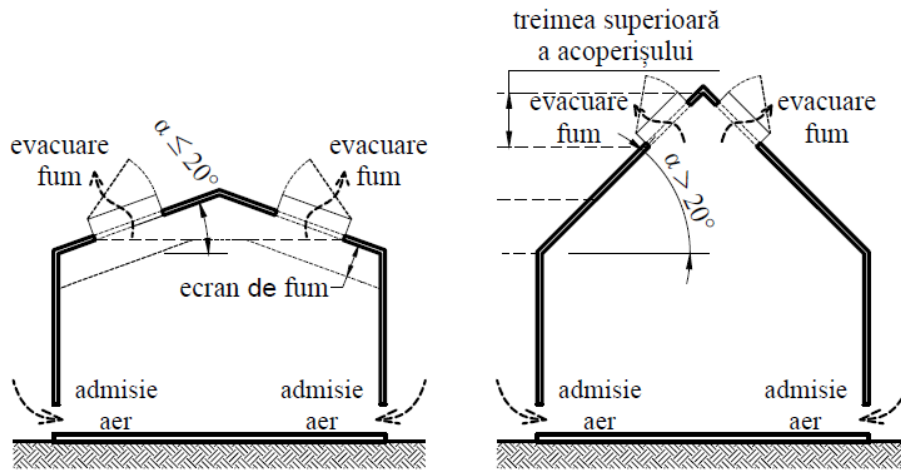
If  $x_1 + x_2 + x_3 > y_1 + y_2 + y_3 \rightarrow$  is **BASEMENT**  
 If  $x_1 + x_2 + x_3 \leq y_1 + y_2 + y_3 \rightarrow$  is **SEMIBASEMENT**

**Figure 11 - Semibasement/basement determination**

**31) Smoke exhaust device (holes) in case of fire** – permanently open or closed gap with a protective device which opens automatically in the event of fire (also fitted with manual operation), operated in the upper third of perimeter closures of the room (external walls) or in the roof, and allowing the smoke produced in the event of fire to be exhausted (as shown in Figure 12), certified according **SR EN 12101-2**.



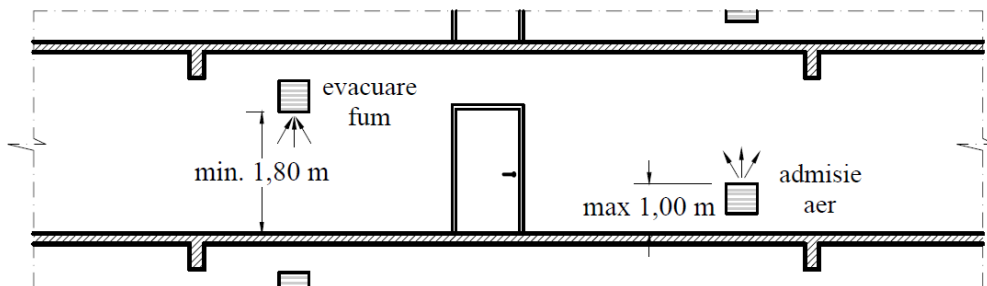




evacuare fum	smoke discharge
ecran de fum	smoke screen
admisie aer	air intake
treimea superioară a acoperișului	upper third of roof

**Figure –12 – Smoke exhaust devices (holes) in the event of fire**

**32) Air inlet device (hole) in case of fire** – a permanently open or closed gap with a protective device which opens automatically in the event of fire and is also fitted with manual operation, operated in the lower part of the perimeter closures of the room from which the smoke is evacuated (external walls), as close as possible to the floor (operated in the lower third as shown in Figure 13).



evacuare fum	smoke discharge
admisie aer	air intake
min. 1,80 m	min. 1.80 m
max 1,00 m	max 1.00 m

**Figure – 13 – Device (hole) for the inlet of air in the event of fire and for the exhaust of smoke in the event of fire**

**Note Figure 14:** Location of air inlet devices (in lower third, at max. 1.00 m to the final state of the floor coverings) in the event of fire and for the exhaust of smoke in the event of fire from **Figure 14** to be used for areas/rooms with maximum clear height of 3.00 m. For those with a height greater than 3.00 m, the devices for the inlet of air in the event of fire shall be located in the lower third and those for the exhaust of smoke in the event of fire shall be located in the upper third of the height of the space/room.

**33) Structural elements** – load-bearing elements of a building which ensure its stability in the event of fire.

**34) Building element** – an integral part of a construction (floors, walls, beams, pillars, doors and crossings, facades, etc.)

**35) Separation element** – material barrier intended to withstand the propagation of the fire from one side of the barrier to the opposite side.

1. **Fire division separation bulkhead (fire bulkhead)** – vertical separating element of two structures or parts of a construction, made up of materials classified as reaction to fire **A1** or **A2s1d0**, designed and constructed so as to provide minimum standardised fire resistance **REI 180 or EI-M 180**(includes resistance to horizontal actions that occur during the fire in the charging grouping specific to this design situation), preventing the spread of fire beyond the wall in the event of a collapse of the structure on one side of the separation wall.
2. **Fire compartment separation floor (fire floor)** – horizontal or inclined element separating two parts of construction, made of materials classified as reaction to fire **A1** or **A2s1d0**, designed and constructed so as to provide minimum standardised fire resistance **REI 120**.
3. **Fire resistant wall or floor** – a building element, vertical/horizontal or inclined, having fire resistance at least equal to the standardised level (depending on the fire protection role it has).
4. **Explosion resistant wall or floor** – vertical, horizontal or inclined building element made of materials without internal gaps, reaction to fire class **A1**, (except as provided for by the Rule in the chapters dedicated to ‘explosion’), formed and dimensioned in such a way as to resist the pressure of the volumetric explosive in an enclosed space. When separating fire compartments, the elements must also meet the standard fire resistance conditions.
5. **Explosion resistant building element** – products certified according to Directive 2014/34/EU – ATEX.
  - a) **Explosion (volumetric)** – sudden expansion of a gas which may result from a rapid oxidation or decomposition reaction, with or without temperature rise.

**Note:** A wall made up of materials which do not produce sparks may be considered an explosion-resistant wall (in the absence of other calculations), i.e. a minimum reinforced concrete wall **B 200 (class C12/15)** of a thickness of at least **15 cm**, with a percentage of reinforcement of at least **0.1 %** or made of solid red brick, reinforced with steel welded netting on both sides, having a thickness of **37.5 cm** and **M 25** mortar brand.

6. **Load-bearing wall** – vertical structural building element.
7. **Non-load-bearing wall** – a vertical or inclined building element with no structural role.

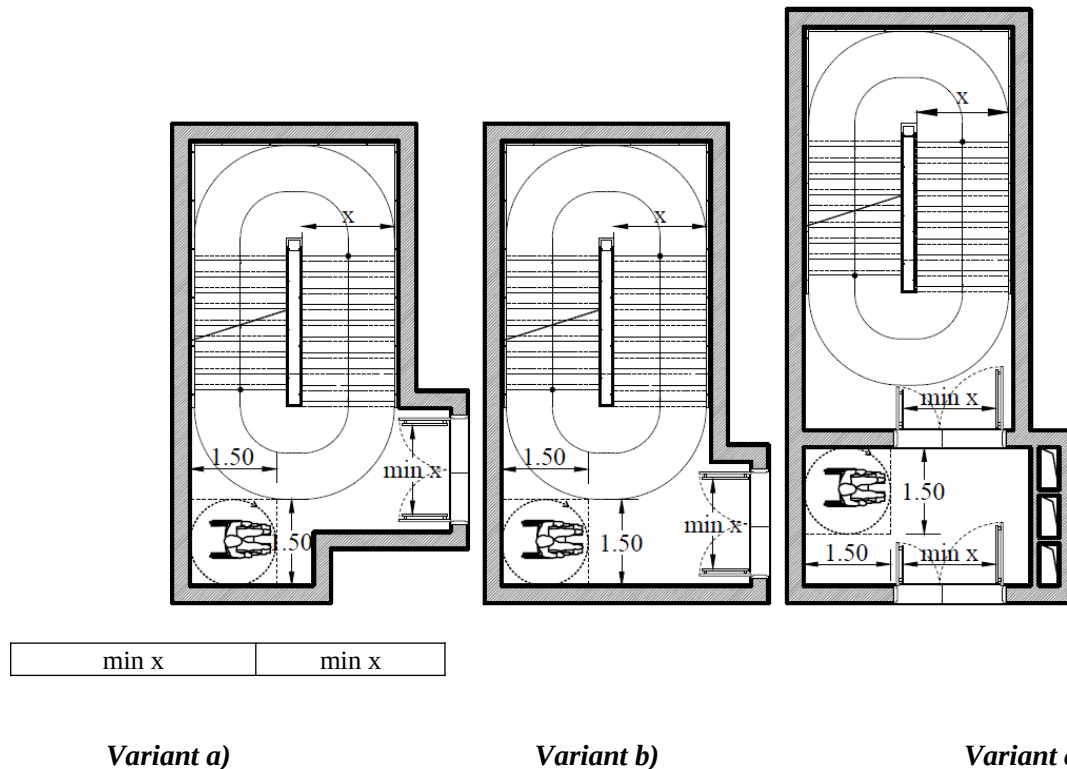
**36) Insulating glazing element** – assembly consisting of at least two glass panels, separated by one or more spacer rods, hermetically sealed along the perimeter, stable and mechanically resistant. Glass panels may be of a monolithic or laminated type, the latter consisting of at least two glass panels glued together with one or more special sheets.

**37) Simple glazing element** – panel consisting of a glass of the monolithic or laminated type.

**38) Escape** – action taken to reach a **safe shelter** or in **safety zone**;

**1.Safe shelter** – temporary location providing protection against an immediate danger due to the effects of fire (as shown in Figure 14)<

**Note:** For example, a place where a person in a wheelchair can wait for help in relative security. It can also be a waiting area in high, very high buildings or for people who cannot evacuate themselves (according to the definition), which gives people the chance to rest before continuing their escape to a **safety zone** (or wait for rescue teams to evacuate them to a safety zone);

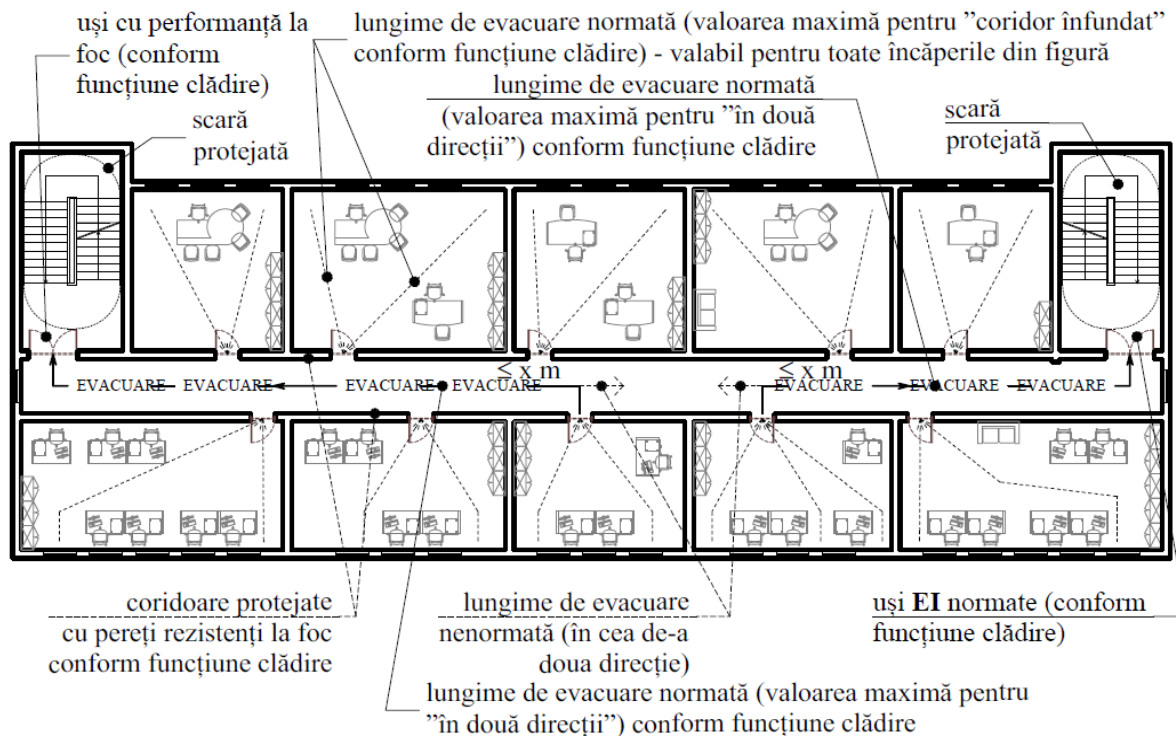


**Figure 14 – Safe shelter (represented by a stationary point for persons with disabilities, being a relative security area for their temporary location)**

*Location in the escape staircase (variant a and b) or in the ventilated buffer room under excess pressure (variant c).*

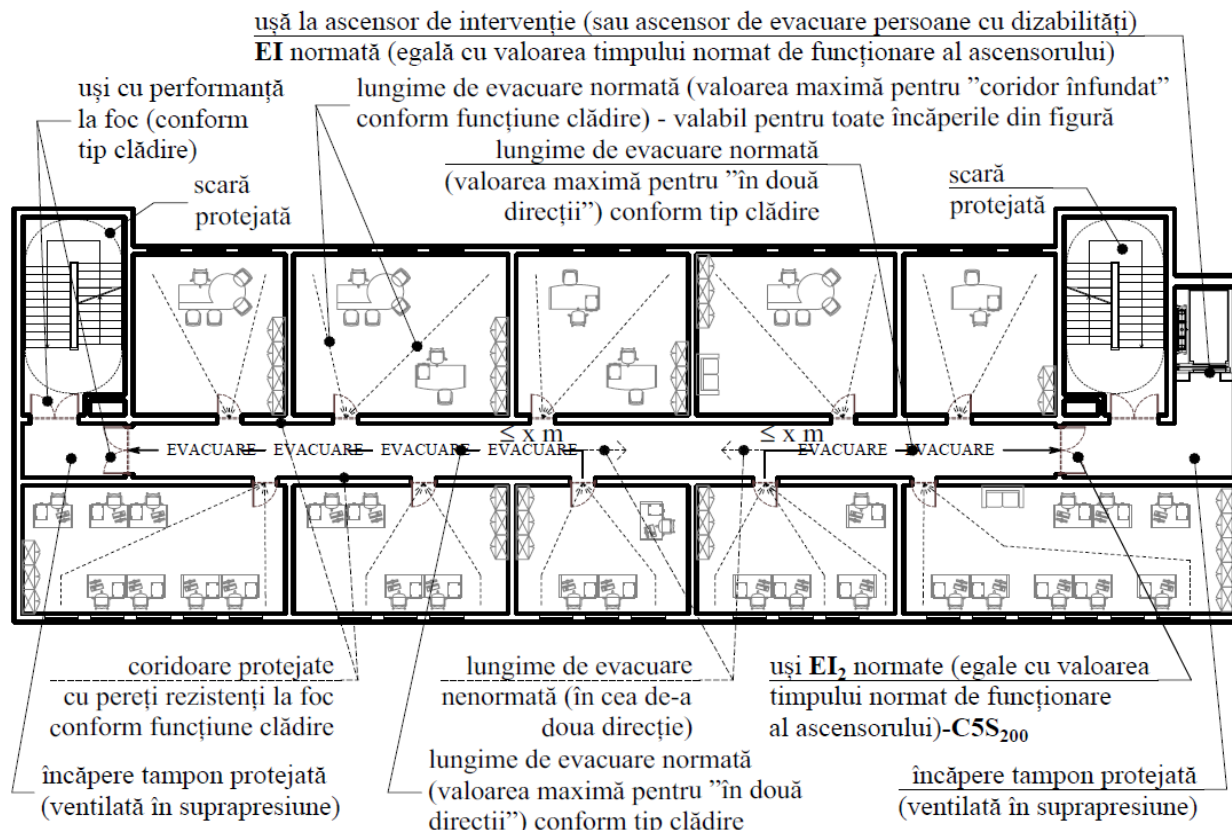
**2. Fire safety area** – an area without danger due to an ongoing fire and from which it is possible to move freely without exposure to its effects. In general, in the event of a fire in a building, the safety zone is a place outside the building. Protected areas inside a building can be considered as **relative safety zones** before escape from the building.

**3. Length of escape path** (escape in the event of fire) – distance to be travelled by bypassing furniture or other obstacles by a person from any point in a construction to the nearest exit to outdoors, protected buffer room, protected clearance or escape staircase. The length of the escape route shall be calculated on the axis of the route travelled from the point of departure of the user to the nearest escape door (as shown in Figure 15). The axis of the route travelled means the axis of escape routes on horizontal and vertical common traffic (stairways) and the axis of internal functional paths in rooms or open space type of spaces (bypassing furniture or other obstacles).



uși cu performanță la foc (conform funcțiune clădire)	doors with fire performance (according to building function)
scară protejată	protected staircase
lungime de evacuare normată (valoarea maximă pentru "condor înfundat" conform funcțiune clădire) - valabil pentru toate încăperile din figură	standardised escape length (maximum value for 'dead-end corridor' according to building function) - valid for all rooms in the figure
lungime de evacuare normată (valoarea maximă pentru "în două direcții") conform funcțiune clădire	standardised escape length (maximum value for 'in two directions') according to building function
scară protejată	protected staircase
EVACUARE	ESCAPE
coridoare protejate cu pereți rezistenți la foc conform funcțiune clădire	protected corridors with fire resistant walls according to building function
lungime de evacuare nenormată (în cea de-a doua direcție)	non-standardised escape length (in the second direction)
lungime de evacuare normată (valoarea maximă pentru "în două direcții") conform funcțiune clădire	standardised escape length (maximum value for 'in two directions') according to building function
uși EI normate (conform i funcțiune clădire)	standardised EI doors (according to building function)

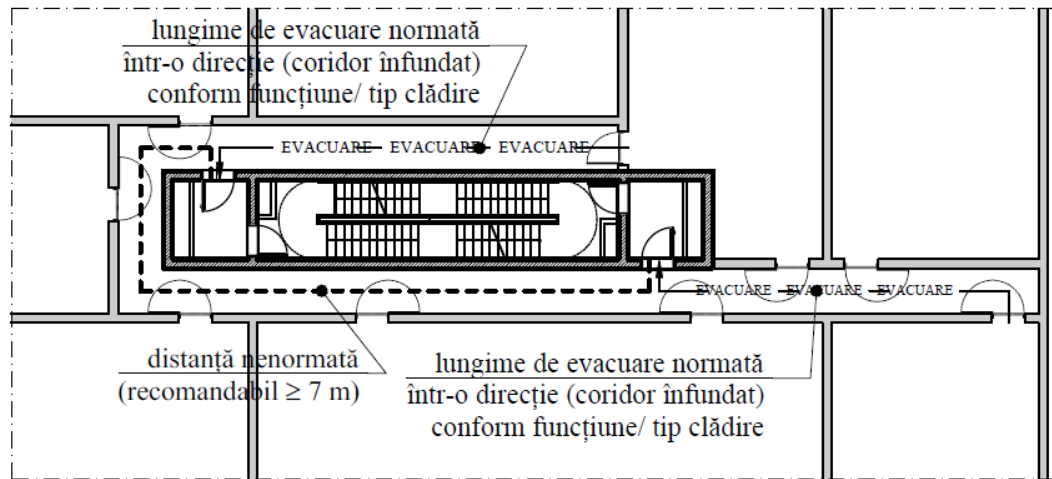
**Variant a) – Escape lengths in buildings of normal height inside rooms via the axis of functional internal paths (bypassing furniture objects or other obstacles) and lengths on horizontal common paths (at the centre of the escape path)**



ușă la ascensor de intervenție (sau ascensor de evacuare persoane cu dizabilități)	door to the intervention lift (or escape lift for disabled persons)
<b>EI</b> normală (egală cu valoarea timpului normal de funcționare al ascensorului)	<b>EI</b> standardised (equal to the value of the lift's normal operating time)
uși cu performanță la foc (conform tip clădire)	doors with fire performance (according to building type)
scară protejată	protected staircase
lungime de evacuare normală (valoarea maximă pentru "coridor înfundat" conform funcțiune clădire) - valabil pentru toate încăperile din figură	standardised escape length (maximum value for 'dead-end corridor' according to building operation) – valid for all rooms in the figure
lungime de evacuare normală (valoarea maximă pentru "în două direcții") conform tip clădire	standardised escape length (maximum value for 'in two directions') according to building type
EVACUARE	ESCAPE
coridoare protejate cu pereți rezistenți la foc conform funcțiune clădire	protected corridors with fire resistant walls according to building function
încăpere tampon protejată (ventilată în suprapresiune)	protected buffer room (over pressure ventilated)
lungime de evacuare nenormată (în cea de-a doua direcție)	non-standardised escape length (in the second direction)
lungime de evacuare normală (valoarea maximă pentru "în două direcții") conform tip clădire	standardised escape length (maximum value for 'in two directions') according to building type
uși <b>EI</b> <sub>2</sub> normale (egale cu valoarea timpului normal de funcționare al ascensorului)-C5S <sub>200</sub>	<b>EI</b> <sub>2</sub> standardised doors (equal to the value of the standard service time of the lift)-C5S <sub>200</sub>
încăpere tampon protejată (ventilată în suprapresiune)	protected buffer room (over pressure ventilated)

**Variant b) – Escape lengths at high or very high buildings inside rooms via the axis of internal functional paths (bypassing furniture objects or other obstacles) and lengths on horizontal common movement (at the centre of the escape path)**

Note to Figure 15 Variant a) and Variant b): dotted lines inside rooms represent the normal escape length (maximum value for one direction/‘dead-end corridor’) according to building function or type



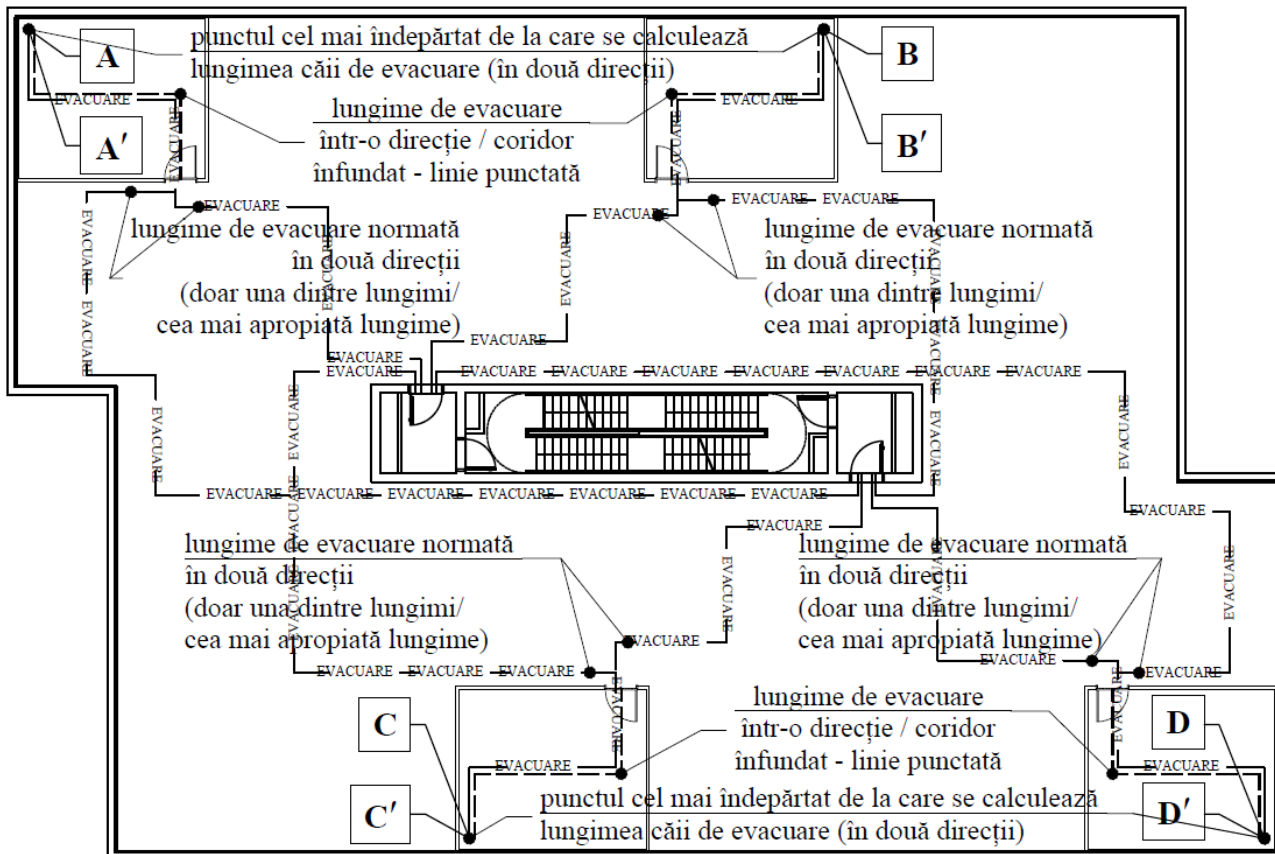
lungime de evacuare normată într-o direcție (coridor înfundat) conform funcțiune/ tip clădire	normal escape length in a direction (dead-end corridor) according to building function/type
EVACUARE	ESCAPE
distanță nenormată (recomandabil $\geq 7$ m)	non-standardised distance (recommended $\geq 7$ m)
lungime de evacuare normată într-o direcție (coridor înfundat) conform funcțiune/ tip clădire	normal escape length in a direction (dead-end corridor) according to building function/type

**Variant c) – Escape lengths in the ‘dead-end corridor’ situation (corridors are provided with fire resistant walls)**

**Notes to Figure 15, variant c):** 1) in the case of rooms bounded by separation elements (wall) with fire resistance performance and only where the length prescribed for escape in one direction (length of dead-end corridor) is not exceeded, the length of the escape route shall be measured from the access door in the separation element (wall) with fire resistance performance to horizontal common paths.

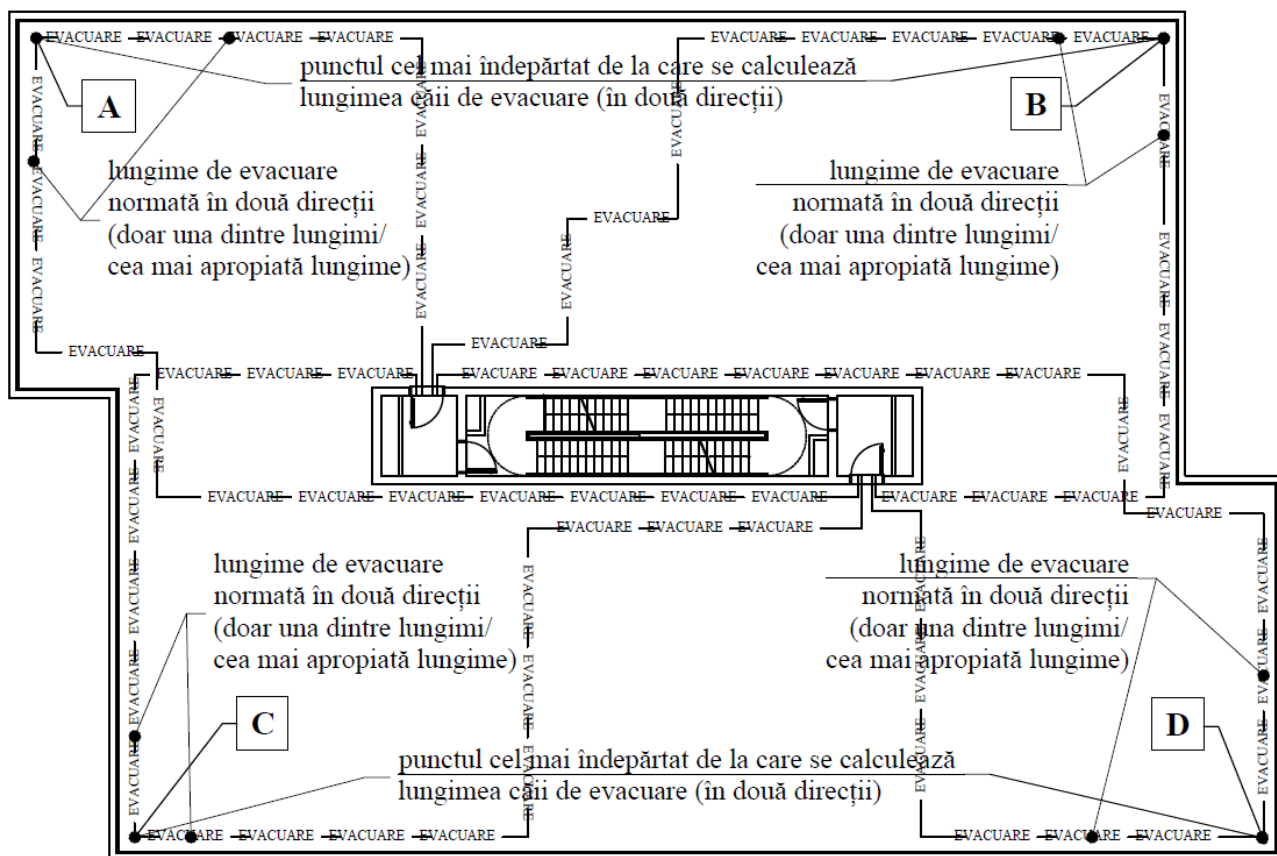
2) In the case of dead-end corridors, for constructions where two escape routes are mandatory, for rooms bounded by separation elements (wall) with fire resistance performance, the length of the escape route, measured from the last door of the room from which users are evacuated to the nearest exit (stairway, protected clearance or buffer room protected by access to the nearest escape staircase or a door/exit directly to the outside), shall be the maximum value set by the Rule for one direction.

3) The escape length in the case of dead-end corridors up to the second exit (stairway, protected clearance or buffer room protected by access to the nearest escape staircase or a direct outdoor/exit) is not standardised. Also, the distance between the prescribed escape doors between the two staircases is not limited (it is recommended that it be  $\geq 7$  m), being generated by access door configurations in the spaces that the escape routes serves.



punctul cel mai îndepărtat de la care se calculează lungimea căii de evacuare (în două direcții)	point furthest from which the length of the escape route is calculated (in two directions)
lungime de evacuare într-o direcție / coridor înfundat – linie punctată	escape length in one direction/dead-end – dotted line
EVACUARE	ESCAPE
Lungime de evacuare normată în două direcții (doar una dintre lungimi/ cea mai apropiată lungime)	Standardised escape length in two directions (only one of the lengths/nearest length)

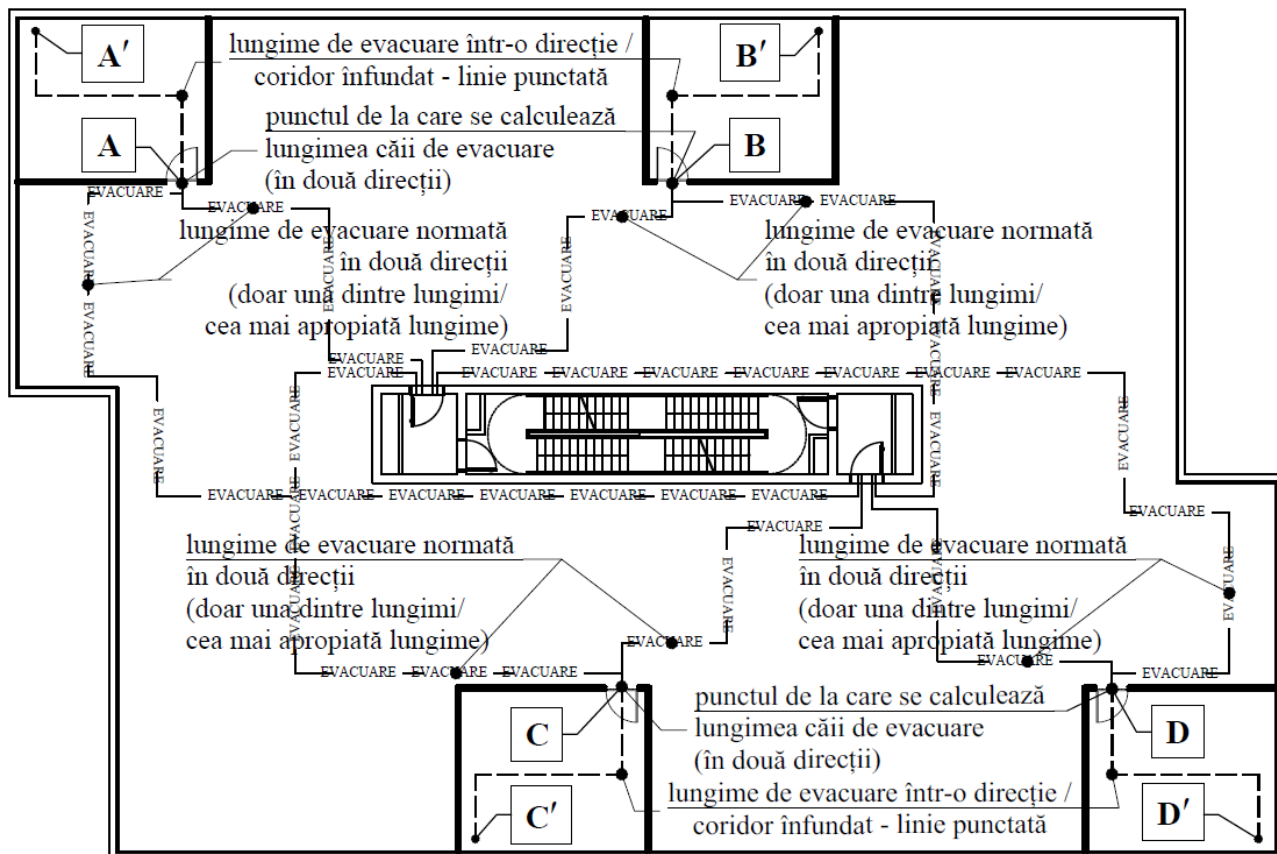
**Variant d1) – Escape lengths in open spaces fitted with non-fire-resistant partitions**



punctul cel mai îndepărtat de la care se calculează lungimea căii de evacuare (în două direcții)	point furthest from which the length of the escape route is calculated (in two directions)
lungime de evacuare normată în două direcții (doar una dintre lungimi/ cea mai apropiată lungime)	normal escape length in two directions (only one of the lengths/nearest length)
EVACUARE	ESCAPE

**Variant d2) – Non-partitioned open space escape lengths**





lungime de evacuare într-o direcție coridor înfundat - linie punctată	evacuations length in one dead-end corridor direction – dotted line
punctul de la care se calculează lungimea căii de evacuare (în două direcții)	point from which the length of the escape route is calculated (in two directions)
lungime de evacuare normata in două direcții (doar una dintre lungimi/ cea mai apropiată lungime)	normal escape length in two directions (only one of the lengths/nearest length)
EVACUARE	ESCAPE

### Variant d3) – Escape lengths in open spaces fitted with fire resistance partitions

**Notes to Figure 15, variant d1), d2) and variant d3):** In the case of rooms comprising unenclosed spaces of separating elements with fire performance (divided by furniture and/or bulkheads, opaque panels or glazed panels generating unpartitioned plenum or continuously raised floor), within which the length of the dead-end corridor is not exceeded, the length of the escape route shall be calculated from the furthest point (to maximum **40 cm** from the wall or according to the plan of furnishing) of the unenclosed spaces up to the entrance to the nearest protected space (protected buffer room, protected clearance, escape staircase, etc.) or to the nearest exit to outdoors. The length of the escape route, measured from the furthest point (to maximum **40 cm** in relation to the wall or according to the furnishing plan) of spaces not delimited by separation elements with fire performance through which users are evacuated to the nearest protected space (protected buffer room, protected clearance, escape staircase, etc.) or to the nearest exist to outdoors, is the maximum value set by the Rule for 2 directions when necessary. For open space spaces it is recommended to ensure a minimum of two distinct and independent escape routes, including when using partitions, in which case partitions without fire performance are placed at minimum **1.80 m** from the fire resistant walls associated to traffic nodes.

**Figure 15 - Escape lengths**

**4. Escape time** – time elapsing between the fire alarm emitted to users and the moment when users of a specified part of the building or of the whole building are able to enter into a **safety zone**;

**5. Means of escape**– constructive means (structural or independent of the building structure) through which safe routes are fitted, allowing people to move from one point to another of a building to a **safety zone**;

**39) Section factor** (for a metal element) – is the ratio of the area of the surface exposed to fire over the unit length to the volume of the metal element per unit length. For a metal element whose surface is not directly exposed to the action of fire, the section factor is the ratio of the inner surface over the unit length of the coating exposed to fire and the volume of the metal element per unit length.

- **Critical temperature of the structural metallic element** - for a certain level of charge\* the critical temperature is the temperature corresponding to the failure of the structural element (assuming a uniform distribution of temperature over the metallic element).

- **Mass factor** ( $m^{-1}$ ) – ratio between the perimeter of the metal profile and the area of the section

**Notes:**

1) \* – refers to the combination of loads corresponding to the accidental situation, which includes the action of fire

2) The section factor temperature is calculated as follows:

- For unprotected inner steel structure – according to 4.2.5.1 of Eurocode 1993-1-2: 2006 where section factor  $A_m/V$  for unprotected steel elements shall be calculated according to Table 4.2 of Eurocode 1993-1-2: 2006;

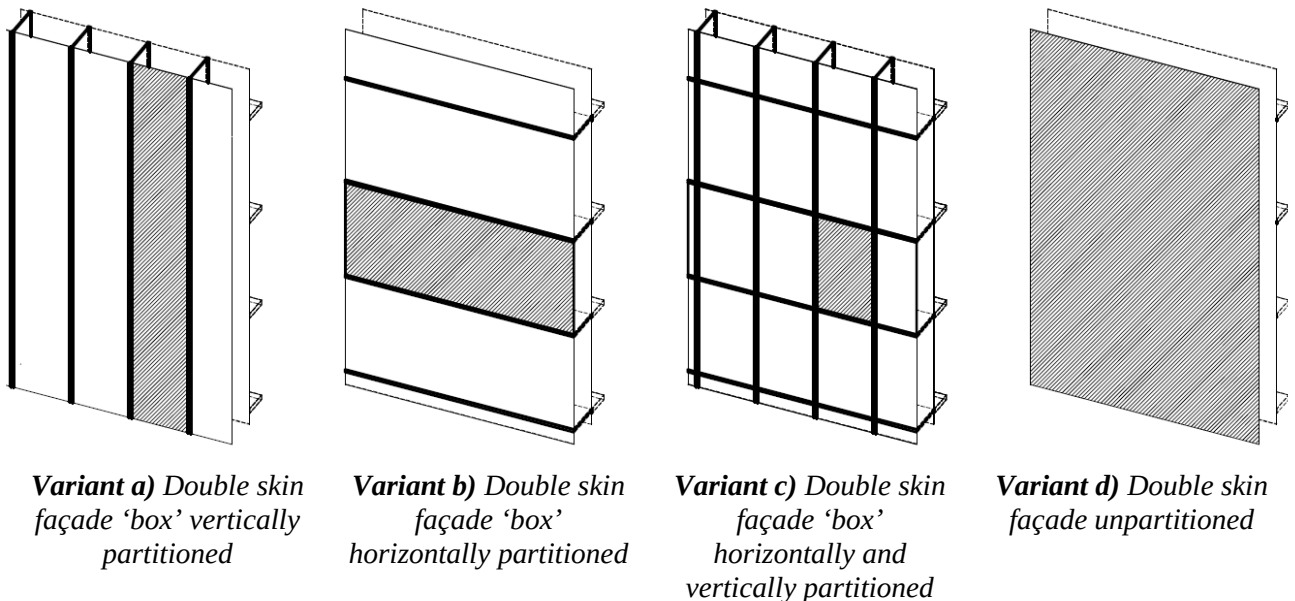
- For steel interior structure protected with fire protective material – according to 4.2.5.2 of Eurocode 1993-1-2: 2006 where the section factor  $A_p/V$  for the steel element insulated by the protective material shall be calculated according to Table 4.3 of Eurocode 1993-1-2: 2006;

- For internal structural steel elements protected by thermal screens – according to 4.2.5.3 of Eurocode 1993-1-2: 2006;

- For external structural elements of steel – according to 4.2.5.4 of Eurocode 1993-1-2: 2006.

**40) Façade** – perimeter closure of the construction – building elements, excluding the roof, which make up the building envelope and isolate it from the outside.

1. **Double façade ('double skin')** – a construction consisting of an inner and an outer covering with an intermediate, ventilated air space designed to fulfil the function of a curtain wall. The double façades are of several types, depending on the ventilation system of the intermediate air space (mechanical, natural or mixed) and subdivision thereof (as shown in Figure 16).



**Figure 16- Double façades (with two sheets of glass/double skin) – types**

2. **Unventilated façade (façade with unventilated composition)** – the outer part of an external closing wall consisting of a perimeter closure system with unventilated composition (compact or non-ventilated air layer).
3. **Ventilated façade (façade with ventilated composition)** – facade system in which the finish has ventilated composition. One of the components of the finishing system is provided with a naturally ventilated (weak or strong) air blade. The air blade is located between the outer face of the supporting wall or thermo-insulating layer (if any) and the inner face of the building element between the ventilated air layer and the outside atmosphere (structure which may or may not be thermo-insulated, the outer face may be opaque or glazed).
4. **Closing wall on the outside** – structural or non-structural building element, made of masonry, concrete, on lightweight metal structures, wood, corrugated sheet sandwich panels and thermo-insulation, etc. (**outer wall** – wall forming the outer envelope of a building, including glazed elements, which may be separately exposed to an indoor or external fire – According to **SR EN 13501-2; SR EN 1364-1 and SR EN 1365-1**)

**41) Girdle** – closed vertical channel under construction for installations (piping, cables, tubing, etc.).

**42) Fire (general term)** – combustion process characterised by heat and fire effluents and generally accompanied by smoke, flames, incandescent or a combination of these elements

1. **Fire (uncontrolled)** – self-sustaining combustion that has not been deliberately organised to produce useful effects and whose propagation over time and space is not controlled
2. **Widespread fire** – phase in which all combustible materials are involved in a fire; flame burn state of all combustible materials during a fire.
3. **'Flashover'/Generalised inflation** < moment of fire > – change to the generalised burning phase of the surface of all combustible materials exposed to a fire in an enclosure
4. **Fire classification** – standardised fire classification system according to the nature of the fuel. There are six fire classes:
  1. - Class A: fire involving solid materials, generally of an organic nature, the combustion of which normally occurs with incandescent ember formation;
  2. - Class B: fire involving liquid or liquefiable solids;
  3. - Class C: fire involving gases;
  4. - Class D: fire involving metals;
  5. - Class E: fire involving hazards of electrical origin (In **SR EN 2** class E is not mentioned);
  6. - F-class: fire involving oils or fats for cooking
5. **Fire effluents** – all gases and aerosols, including particulate matter, released by combustion or pyrolysis and emitted and disseminated in the environment;
6. **Smoke** – visible part of fire effluents;
7. **Flame** – rapid, self-sustaining and subsonic spread of combustion in a gaseous environment, generally accompanied by light emission;

**43) Non-combustible** -material or product incapable of burning under specified conditions.

1. **fuel**, adjective – capable of being lit and burning
2. **fuel**, noun – object capable of initiating combustion

Note 1: In the content of the Rule, non-combustible materials or products which have the reaction to fire class are considered to be **A1** or **A2-s1d0** non-combustible materials or products.

Note 2: Materials or products capable of burning under specified conditions (being considered as combustible materials or products in the Rule) have a reaction to fire class other than **A1** or **A2-s1d0**.

**44) Flammability** – ability of a material or product to burn with a flame under specified conditions.

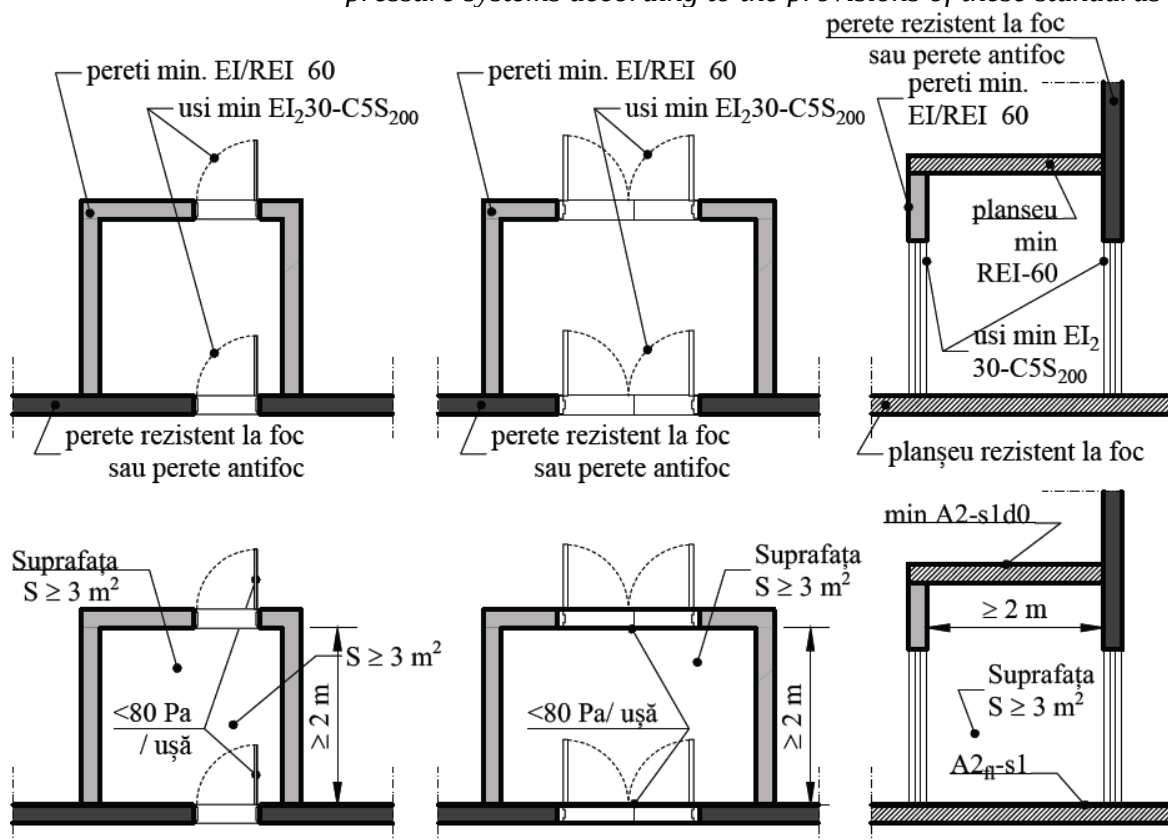
1. **Flammable** – material or product capable of burning with a flame under specified conditions.
2. **Non-flammable**– unable to burn with a **flame** under specified conditions

**45) Room** – building specific unit, delimited by walls and floors with reaction-to-fire performance prescribed by the Rule according to its intended purpose and/or fire risk;

1. **Buffer room** – operating and escape gap protection room in walls, thus compliant, constructed and equipped as to correspond to its role in the event of fire (Figure 17). Buffer rooms shall be provided with one of the following systems:

i. with mechanical smoke and hot gas exhaust systems (mechanical intake of air and mechanical smoke discharge);

ii. with differential pressure systems (**SPD**) (over pressure) - according to standards **SR EN 12101-6** - Smoke and heat control systems. Part 6: Specification for pressure differential systems. Kits and **SR EN 12101-13** – Smoke and heat control systems. Part 13: Pressure differential systems (**PDS**). Methods of design and calculation, installation, acceptance testing, periodic testing and maintenance, buffer rooms shall be equipped with differential pressure systems according to the provisions of these standards



pereți min .EI/REI 60	walls min. EI/REI 60
usi min EI <sub>2</sub> 30-C5S <sub>200</sub>	doors min. EI <sub>2</sub> 30-C5S <sub>200</sub>
perete rezistent la foc sau perete antifoc	fire resistant wall or fire wall
planșeu rezistent la foc	fire resistant floor
sau perete antifoc	or fire wall
planșeu min REI-60	floor min. REI-60

panseu rezistent la foc	fire resistant floor
Suprafața $S \geq 3 \text{ m}^2$	Area $S \geq 3 \text{ m}^2$
<80 Pa / ușă	<80 Pa / door
min A2-s1d0	min. A2-s1d0

- a. **Plane** (door in a wing)                      b. **Plane** (door in two wings)  
c. **Section**

**Figure 17 - Protected buffer room**

2. **Human agglomeration rooms** – rooms or group of rooms that communicate directly with each other through **unprotected** gaps where they can find themselves at the same time at least **50** persons, each of which has a maximum floor area **4 m.<sup>2</sup>**.

**46) Coating** – external component of slope or terrace roofs to ensure that the construction is weathertight (waterproofing). The coating may be continuous (from products applied by soldering/welding, made with waterproofing membranes, bituminous, welded overlay, etc.); semicontinuous (consisting of products mounted by overlaps or joints, made of flat metal sheets joined by fake joints and metal-shaped, heat-insulated panels with watertight overlaps); discontinuous (from materials/products mounted by overlapping). The coatings may be flat (flat terraces); with a slope (in a water, in a shed, in two waters) or with a constant slope (conical, etc.) or with variable slope (cylindrical, dome, ellipsoid, ruled surfaces, etc., splayed shapes)

**47) Limiting the spread of fires** – all the constructive measures and equipment of fire protection installations designed to prevent the spread of fire over a normal period of time, inside or outside the construction works.

**48) Attic** – space built (functionally constructed according to the specific regulation) or functionally arranged between the last floor used for the different uses of the building and the slope roof (or undeveloped attic), which ensures compliance with the safety (security) and comfort requirements appropriate to the specific use. The number of levels of the attic shall be included in the number of above-ground construction levels and shall be taken into account when determining the level of fire stability of the construction.

**Note:** where duplex or triplex dwellings are at the last levels of the attic, only the level of access to them in the common horizontal paths of the building shall be taken into account when determining the height of the construction, the level of access which determines the number of levels and/or the classification in the high building or the building of normal height. It is permissible for a single level to be a duplex or triplex type with access according to the preceding paragraph, the two duplex levels or the three triplex levels being considered as one level, representing the last level of the construction. If the levels of access to duplex or triplex type dwellings are at levels other than that specified above, all levels of the duplex or triplex dwellings shall be taken into account when determining the height of the construction.

**49) Material** – single basic substance or uniformly distributed mixture of substances, e.g. metal, stone, wood, concrete, mineral wool with uniformly distributed binder or polymers (of which a product is made).

- Substantial component** – material constituting a significant part of a non-homogeneous product. A layer of mass/unit surface of  $\geq 1.0 \text{ kg/m}^2$  or a thickness of  $\geq 1.0 \text{ mm}$  is considered as a substantial component
- Non-substantial component** – material which does not constitute a significant part of a non-homogeneous product. A layer of mass/unit surface of  $< 1.0 \text{ kg/m}^2$  and thickness of  $< 1.0 \text{ mm}$  is considered as a non-substantial component. Two or more non-substantial adjacent layers (i.e. without any substantial component (s) between the layers) are considered a single non-substantial component when they together meet the requirements applicable to

a layer constituting a non-substantial component.

a) **Internal non-substantial component** – non-substantial component that is covered on both sides by at least one substantial component;

b) **External non-substantial component** – non-substantial component not covered by a substantial component on one side.

3. **Composite material** – structured association of two or more distinct materials.

4. **Combustible material**, material capable of being lit and burn

5. **Polymeric material** – material consisting of large molecules made up of smaller, repetitive, interlinked chemical units known as polymers. A polymer is a large molecule made up of many smaller, repetitive, interlinked chemical units called monomers. Some polymers are natural, others synthetic.

6. **Substrate** – material that is used immediately below the product on which information is requested (e.g.: for the floor, it is the ground on which it is mounted or the material representing this soil).

i. **Standardised substrate** – material which is representative of the substrate used under the end-use conditions.

**50) Mezzanine** – level interleaved between two levels which differ from the other levels either by their lower clear height or by the absence of balconies or other exits in the façade plane. Mezzanine shall be included in the number of above-ground construction levels and shall be taken into account when determining the level of fire stability of the construction.

**51) Levels (floors)** – overground and/or underground built-up spaces, either closed or open, bounded by floors. The level of the intermediate level construction whose area is greater than 40 % of that of the space in which it is made.

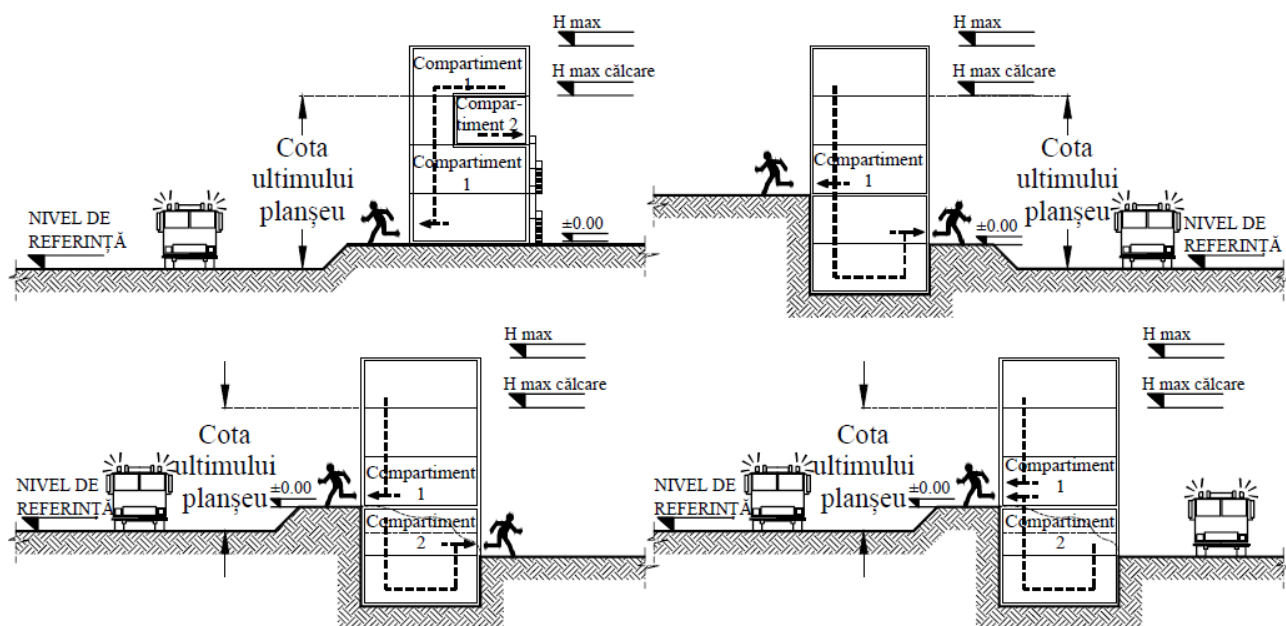
1. **Technical level – technical floor** – special above-ground or underground built-up space delimited by floors, in which facilities for construction are located. (water, sewerage, thermal, electrical, ventilation, telephony, etc. and machinery and/or apparatus for optimum operation of the building in relation to its intended use). Such spaces may have internal partitions according to the requirements for the separation of installations, equipment and its protection. No rooms with other functions (such as accommodation, intervention workshops (repairs) or changing rooms or rest facilities for maintenance staff are permitted in these areas.

**a) technical level above the normal construction limit level** – special above-ground built-up space bounded by the floor, above the standard construction boundary, occupying maximum 50 % of the built-up area of its inferior level shall not be taken into account at the height of the construction and the number of levels of construction.

**b) intermediate technical level** – intermediate technical floor – special built above-ground space, delimited by floors, intermediate between other levels of construction used, having a free height greater than **1.80 m** and it shall be taken into account at the height of the construction and the number of levels of construction.

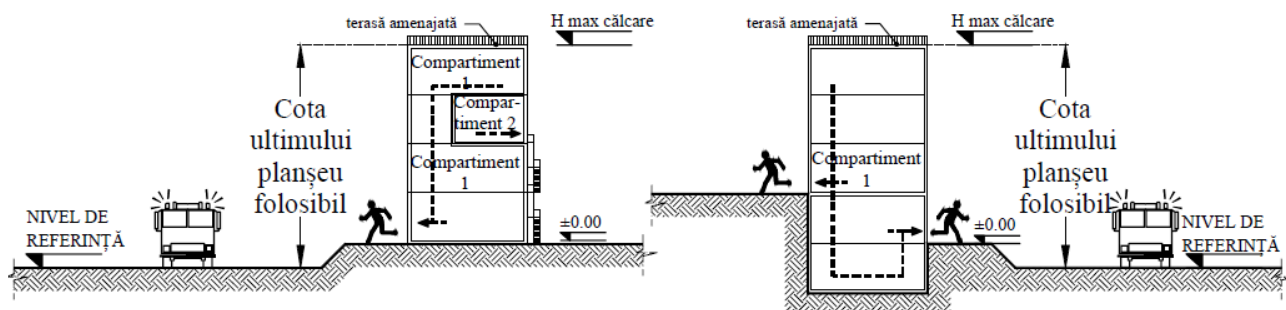
**c) underground technical level** – underground technical floor – specially built underground area bounded by walls and floors below the last reference/used level of construction, having a free height of less than **1.80 m** and it shall be taken into account at the height of the construction and the number of underground levels of the construction. Building drains and underground technical channels with maximum free height of **1.80 m** are not considered a level.

52) **Reference level** – the lowest level of the terrain or road, accessible to the intervention vehicles in the event of fire to which users are evacuated to the outside, and the access of the intervention forces to the building (Figure 18).

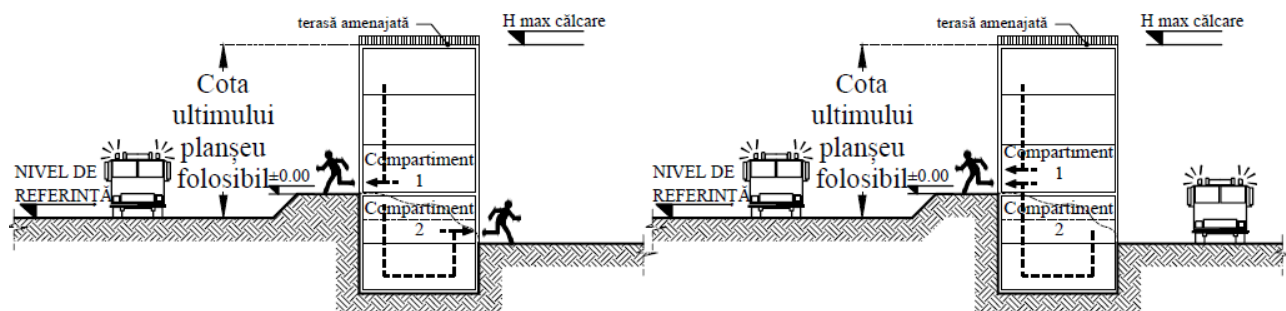


NIVEL DE REFERINȚĂ	REFERENCE LEVEL
Cota ultimului planșeu	Height of last floor
Compartiment	Compartment
H max	H max
H max călcare	H max tread

**Variant a): buildings without spaces arranged on the terrace roof**



NIVEL DE REFERINȚĂ	REFERENCE LEVEL
Cota ultimului planșeu folosibil	Height of last usable floor
Compartiment	Compartment
terasă amenajată	arranged terrace
H max călcare	H max tread



NIVEL DE REFERINȚĂ	REFERENCE LEVEL
Cota ultimului planșeu folosibil	Height of last usable floor
Compartiment	Compartment
terasă amenajată	arranged terrace
H max călcare	H max tread

**Variant b): buildings with spaces arranged on the terrace roof**

**Note Figure 18, Variant b):** The height of the buildings at which the terrace roof is designed for various functions such as car parks, commerce, etc. shall be determined taking into account the rate of the walkable terrace relative to the reference level.

**Figure 18 - Reference level**

**53) Fire stability level** – the overall standardised capability of a construction or fire compartment to respond to the action of a standard fire. The fire stability level of the construction or fire compartment shall be determined by its most unfavourable element within the standard values.

**54) Open space** – open space (e.g. work – administrative function), for activities requiring frequent communication, or grouping of rooms with the same fire risk and purpose (own or complementary used in current operation) divided by furniture and/or bulwarks, opaque or glazed panels, fixed or movable used as functional and/or soundproofing separations (Figure 20). Delineation opaque or glazing panels which interrupt the space between the non-combustible suspended ceiling from the floor and/or the space between the non-combustible raised floor and the lower floor within groupings with the standardised surface in conjunction with the lengths of escape routes, shall be constructed in such a way that the operation of the fire protection installations is not influenced. The grouping of rooms with a low fire risk and the same destination, including collateral destinations, including horizontal functional communications, shall be permitted. The grouping of open space rooms shall be partitioned at the boundary against the common escape paths (corridors, protected communication spaces, buffer rooms, enclosed staircases etc.), as well as against the spaces with different fire risk (from thermal load density and/or operation), with fire resistant walls specific to open space type of spaces or according to the provisions of the adjacent spaces (the most restrictive requirements must be chosen) according to the classification of each function or type of construction. Within the groups of open space spaces, rooms with a higher fire risk (from thermal load density and/or operation) shall be subdivided by fire resistant walls specific to such rooms

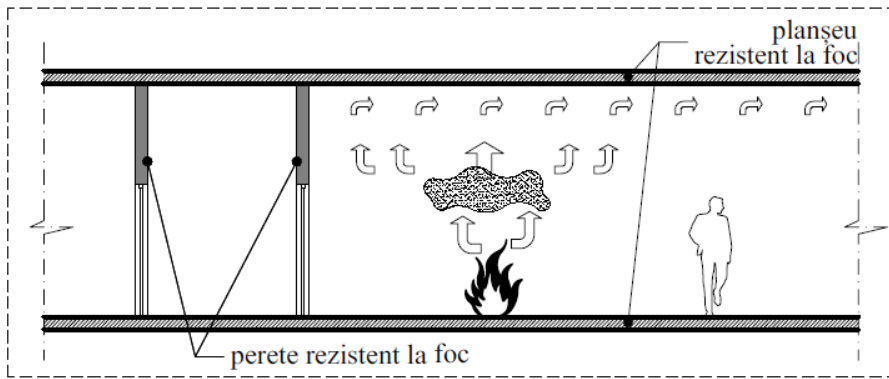
1. Open space rooms with agglomerations of persons are equipped with fire detection, signalling and alarm systems with total coverage and are not recommended to be arranged in spaces not fitted with automatic fire-fighting systems.
2. Open space groupings including crowded rooms shall not be permitted, except in the commercial buildings provided for in the regulation.
3. Open space groupings shall not be permitted in buildings intended for persons who cannot evacuate themselves, with the exception of those explicitly designated in this Rule for buildings with a health function.
4. Sleeping rooms (shared bedrooms) or with sleeping or hospitalisation places (rooms, health building reserves, medical practices, etc.), sleeping areas located in monastery assemblies, sleeping rooms in hotels, hostels, motels, villas, bungalows, cabins, guesthouses, etc., or those located outside the built-up areas of the localities (cabins, refuges, hotels, motels, guesthouses, etc.), hospitals and the like, common homes/bedrooms or home/boarding rooms may not be built in open spaces and must be delineated between them (by minimum internal non-load bearing partition walls used to limit the spread of fire (EI)),



as well as at the boundary to the common traffic paths according to the stability of the construction/fire compartment.

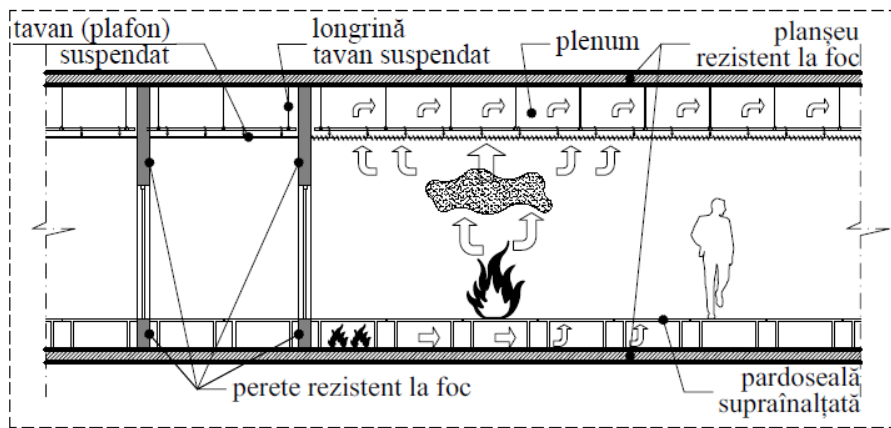
5. Groupings of rooms with the same fire risk and the same (own or complementary) open space destination shall be divided between themselves and at the boundary of the common escape movements (corridors, protected clearance, protected or unprotected buffer rooms, stairway enclosures, etc.) as well as spaces of different fire risk (according to the densities of heat loads ( $q$ ) in adjacent spaces and/or the largest densities of heat loads ( $q$ ) in spaces which they separate and/or which have a different fire risk from operation), depending on whether they are assigned to functions or type of construction, **through walls for containment of fire propagation REI/EI** (fire protection limiting propagation inside fire compartments), according to the classification of the construction/fire compartment to the fire stability level, **if the density of the heat load in adjacent spaces does not produce higher performance.**
6. Each grouping of rooms with the same fire risk and intended use (own or complementary open space, except those described in the previous paragraphs) divided by opaque or glazed panels, fixed or movable, used as functional separation and/or sound insulation or functional partitions, shall be permitted within the following built-up areas:
  - unlimited, provided that the built-up area of the open space is maximum 75 % of that of the built-up area of the respective level for constructions falling within the level **I** of fire stability;
  - maximum **400 m<sup>2</sup>** each grouping, provided that the built-up area of all open space groupings on the level is maximum 75 % of that of the built-up area of the respective level for constructions falling within the level **II** of fire stability;
  - maximum **200 m<sup>2</sup>** each grouping, provided that the built-up area of all open space groupings on the level is maximum 50 % of that of the built-up area of the respective level for constructions falling within the level **III** of fire stability;
  - maximum **100 m<sup>2</sup>** each grouping, provided that the built-up area of all open space groupings on the level is maximum 25 % of that of the built-up area of the respective level for constructions falling within the level **IV** of fire stability;
  - maximum **50 m<sup>2</sup>** each grouping, provided that the built-up area of all open space groupings on the level is maximum 25 % of that of the built-up area of the respective level for constructions falling within the level of **V** of fire stability;
7. Grouping rooms with low fire risk and the same destination, including collateral destinations, including horizontal functional communications (such as changing rooms + toilet facilities; offices + lock chamber functional access; MRI camera + command room + lock chamber access; tomograph computer camera + control room + lock chamber access, etc.) shall be subdivided within the surface limits set out in the preceding paragraph, **through walls for containment of fire propagation REI/EI** (fire protection limiting propagation inside fire compartments), according to the classification of the fire construction/compartment to the fire stability level, **if the density of the heat load in adjacent spaces does not generate higher performance.**

Are not considered open spaces the rooms provided in their interior with fire performance walls (from floor to floor), according to Figure 19. These shall be partitioned in relation to rooms adjacent to fire performance walls (from floor to floor), according to standard provisions.



planșeu rezistent la foc	fire resistant floor
--------------------------	----------------------

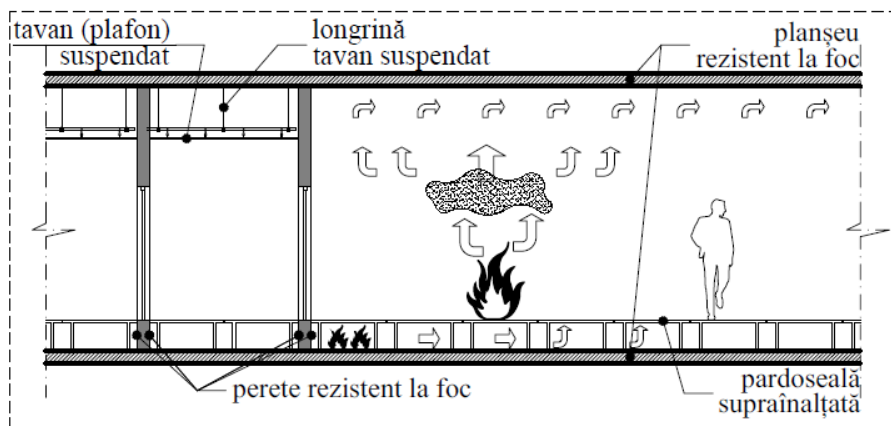
**Variant a) A room fitted with fire resistant walls in relation to adjacent rooms: without raised floor and suspended ceiling – does not create plenum**



tavan (plafon) suspendat	suspended ceiling
longrină tavan suspendat	longitudinal beam of suspended ceiling
plenum	plenum
planșeu rezistent la foc	fire resistant floor
perete rezistent la foc	fire resistant wall
pardoseală supraînălțată	raised floor

**Variant b) A room fitted with fire resistant walls in relation to adjacent rooms: with raised floor and suspended ceiling; the spaces in the suspended ceiling and the raised floor are bound by separation elements (fire resistant walls) in relation adjacent rooms – do not create a plenum**

*Note: adjacent spaces bounded by fire resistant walls may or may not have suspended ceilings*

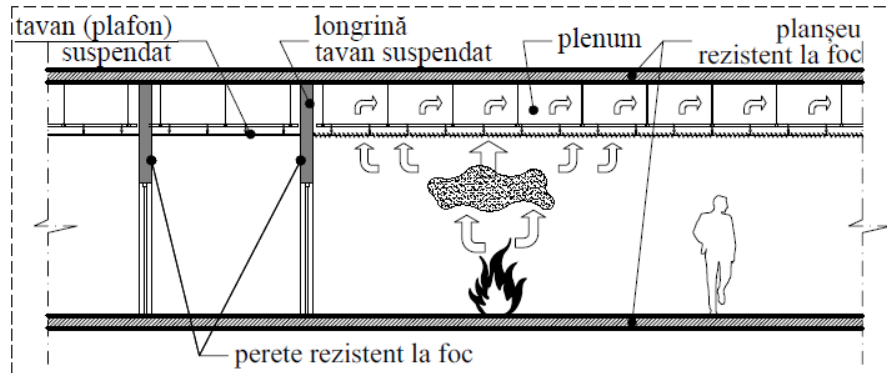


tavan (plafon) suspendat	suspended ceiling
--------------------------	-------------------

longrimă tavan suspendat	longitudinal beam of suspended ceiling
planșeu rezistent la foc	fire resistant floor
perete rezistent la foc	fire resistant wall
pardoseală supraînălțată	raised floor

**Variant c) A room fitted with fire resistant walls in relation to adjacent rooms: with raised floor and no suspended ceiling; the spaces in the raised floor area are bounded by separation elements (fire resistant walls) in relation to adjacent rooms – do not create a plenum**

Note: adjacent spaces bounded by fire resistant walls may or may not have suspended ceilings

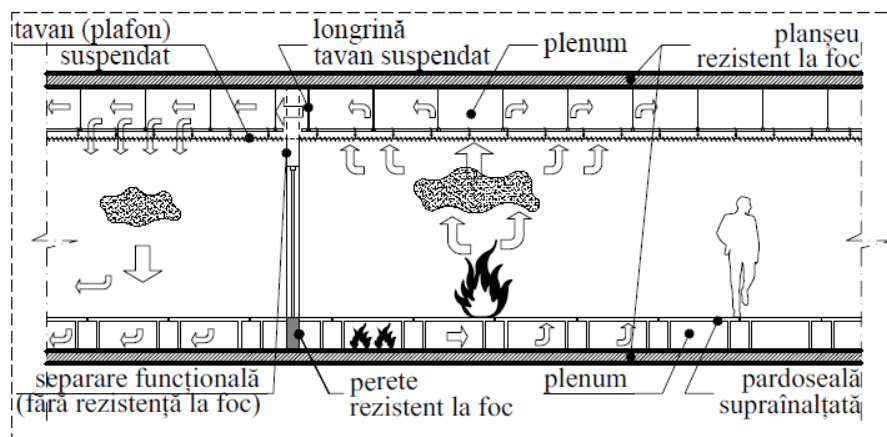


tavan (plafon) suspendat	suspended ceiling
longrimă tavan suspendat	longitudinal beam of suspended ceiling
plenum	plenum
planșeu rezistent la foc	fire resistant floor
perete rezistent la foc	fire resistant wall

**Variant d) A room fitted with fire resistant walls in relation to adjacent rooms: without raised floor and with suspended ceiling; spaces in the suspended ceiling are delimited by separation elements (fire resistant walls) in relation to adjacent rooms – do not create plenum**

Note: adjacent spaces bounded by fire resistant walls may or may not have suspended ceilings

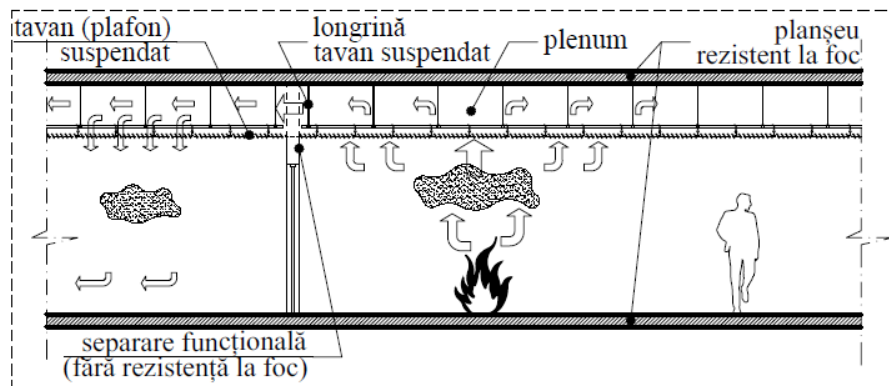
**Figure 19 - Enclosed rooms bounded by fire resistant walls in relation to adjacent rooms**



tavan (plafon) suspendat	suspended ceiling
longrimă tavan suspendat	longitudinal beam of suspended ceiling
plenum	plenum
planșeu rezistent la foc	fire resistant floor
separare funcțională (fără rezistență la foc)	functional separation (without resistance to fire)
perete rezistent la foc	fire resistant wall

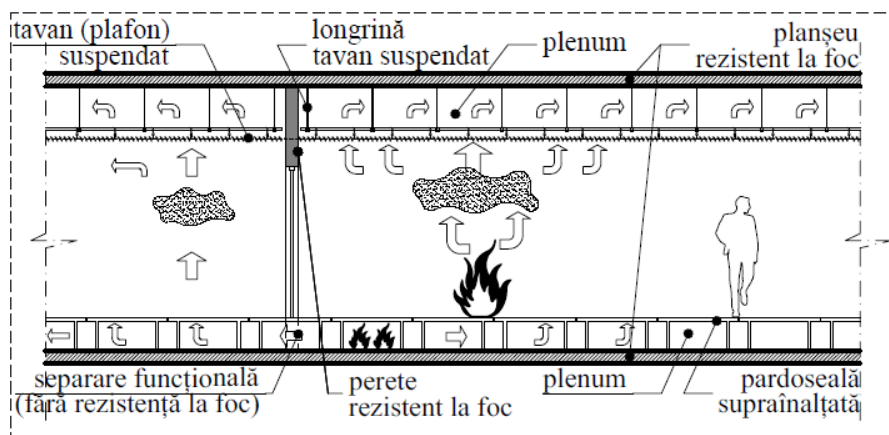
pardoseală supraînălțată	raised floor
--------------------------	--------------

**Variant a) Space with functional separations without fire resistance in relation to adjacent spaces: with elevated floor and suspended ceiling, the spaces in the suspended ceiling are not bounded by fire resistant walls in relation to adjacent spaces – create plenum through the undelimited continuously suspended ceiling**



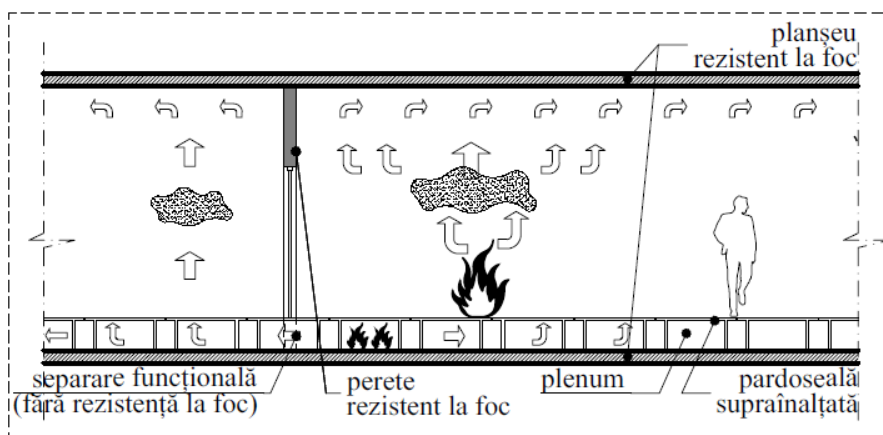
tavan (plafon) suspendat	suspended ceiling
longrimă tavan suspendat	longitudinal beam of suspended ceiling
plenum	plenum
planșeu rezistent la foc	fire resistant floor
separare funcțională (fără rezistență la foc)	functional separation (without resistance to fire)

**Variant b) Space with functional separations without fire resistance in relation to adjacent spaces: without raised floor and with suspended ceiling, the spaces in the suspended ceiling are not bounded by fire resistant walls in relation to adjacent spaces – create a plenum through the undelimited continuously suspended ceiling**



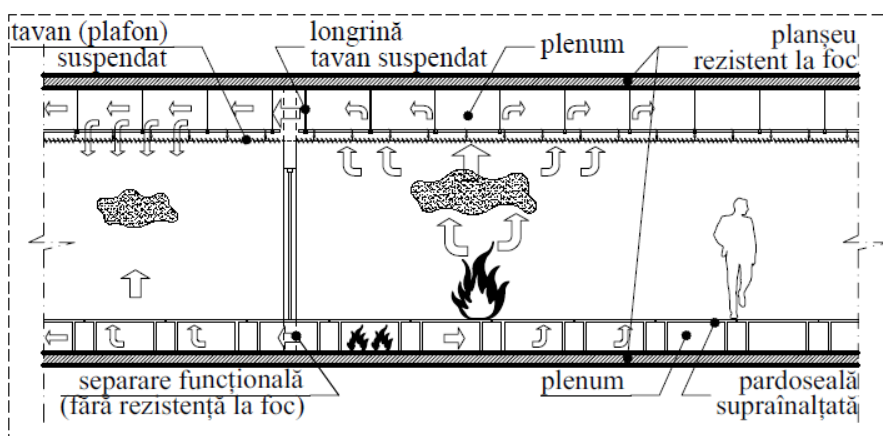
tavan (plafon) suspendat	suspended ceiling
longrimă tavan suspendat	longitudinal beam of suspended ceiling
plenum	plenum
planșeu rezistent la foc	fire resistant floor
separare funcțională (fără rezistență la foc)	functional separation (without resistance to fire)
perete rezistent la foc	fire resistant wall
pardoseală supraînălțată	raised floor

**Variant c) Space with functional separations without fire resistance in relation to adjacent spaces: with elevated floor and suspended ceiling, the spaces in the raised floor are not bounded by fire resistant walls in relation to adjacent spaces – create plenum through the undelimited continuous raised floor**



planșeu rezistent la foc	fire resistant floor
separare funcțională (fără rezistență la foc)	functional separation (without resistance to fire)
perete rezistent la foc	fire resistant wall
Plenum	plenum
pardoseală supraînălțată	raised floor

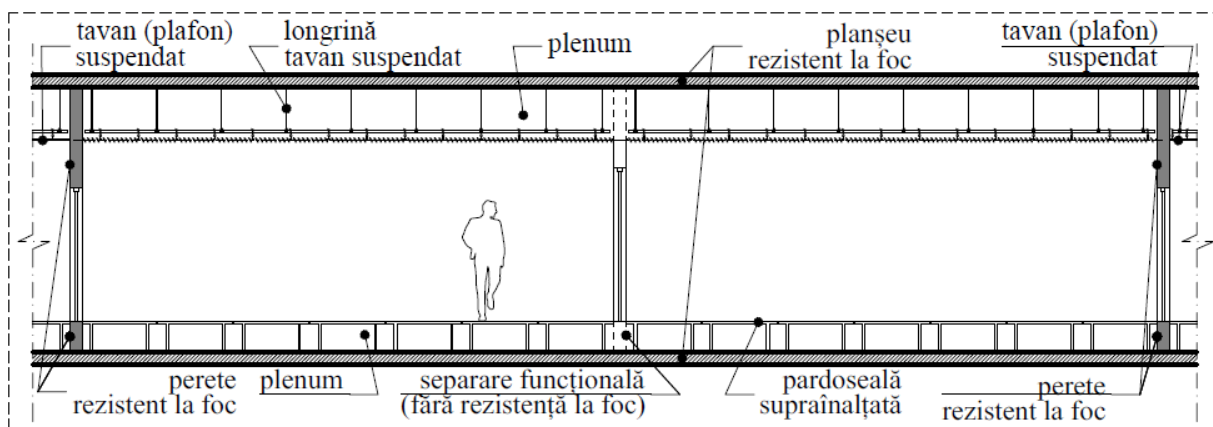
**Variant d) Space with functional separations without fire resistance in relation to adjacent spaces: with raised floor and without a suspended ceiling, the spaces in the raised floor are not bounded by fire resistant walls in relation to adjacent spaces – create plenum through the undelimited continuous raised floor**



tavan (plafon) suspendat	suspended ceiling
longrimă tavan suspendat	longitudinal beam of suspended ceiling
plenum	plenum
planșeu rezistent la foc	fire resistant floor
separare funcțională (fără rezistență la foc)	functional separation (without resistance to fire)
pardoseală supraînălțată	raised floor

**Variant e) Space with functional separations without fire resistance in relation to adjacent spaces: with elevated floor and suspended ceiling, the spaces in the suspended ceiling and the raised floor are not bounded by fire resistant walls in relation to adjacent spaces – create a plenum through the undelimited continuously suspended ceiling and the undefined continuous raised floor**

**Figure 20 - Open spaces**



tavan (plafon) suspendat	suspended ceiling
longrină tavan suspendat	longitudinal beam of suspended ceiling
plenum	plenum
planșeu rezistent la foc	fire resistant floor
perete plenum rezistent la foc	fire resistant plenum wall
separare funcțională (fără rezistență la foc)	functional separation (without resistance to fire)
pardoseală supraînălțată	raised floor

**Figure 21 - Open spaces bounded by fire resistant walls in relation to adjacent rooms**

55) **Coating panels** – self-supporting elements mounted on the roof roofs of buildings, which act as waterproof and, where appropriate, thermal insulation.

56) **Joinery panel** – a non-structural frame, enclosed perimeter or, where appropriate, by anchoring vertical or horizontal profiles, to the building structure, containing transparent and/or opaque, fixed and/or movable (openable) filling elements.

57) **Parking lot** – closed or open above-ground or underground construction with one or more levels intended exclusively for parking motor vehicles and their trailers (in which no repair work is carried out).

1. **Closed parking lot** – construction closed with external perimeter walls and floor.
2. **Overground open parking lot** – open construction with permanently open gaps on at least 50 % of the surface of the external walls intended for housing motor vehicles and their trailers (where no repair work is carried out). In above-ground open parking lots, smoke exhaust shall be ensured through existing perimeter openings under regulatory conditions (smoke discharge voids in external walls shall only be taken into account for a depth not exceeding 30 m)
3. **Natural heavily ventilated above ground parking lot** – a separate category of above-ground open parking lots meeting all of the following conditions:
  - i. — on each parking level, the free surfaces in side walls open outwards shall be located on at least two opposite façades and each represent a minimum of 50 % of the total surface of the open façade, the height taken into account being the free distance between the finished floor and the roof;
  - ii. — the distance between the opposite free façades, open outwards, shall not exceed 75.00 m;

iii. — the perimeter free surfaces, open outwards, at each parking level shall be at least 5 % of the useful area of the parking space of that level; areas of enclosed spaces intended for horizontal and vertical pedestrian movements and other destinations shall not be taken into account;

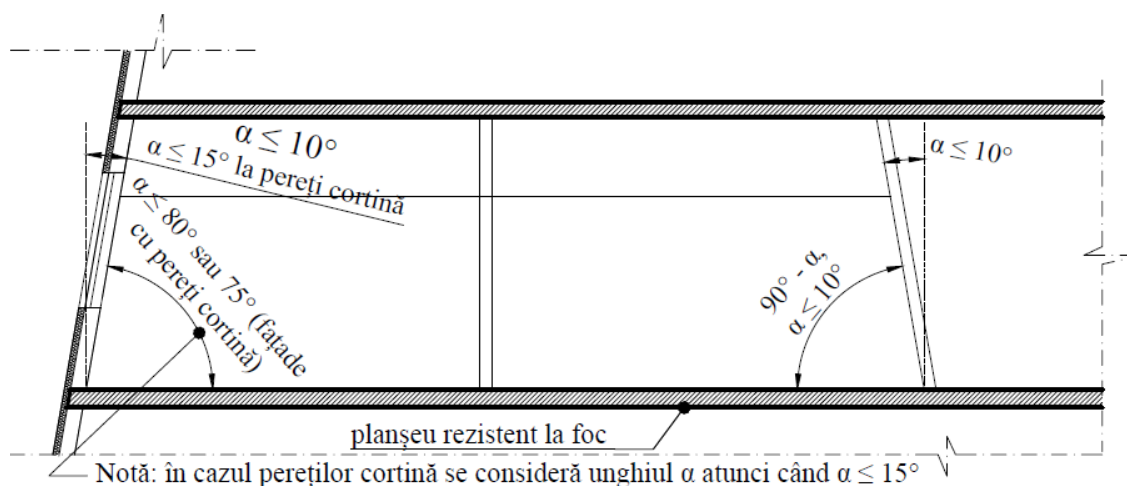
iv. the open outer space shall have the horizontal area at least equal to the sum of the perimeter adjacent free surfaces.

Heavily ventilated parks are deemed to have ensured the exhaustion of smoke and hot gases.

**58) Boarded floor** – a non-structural subset of permanent finishing elements of rooms and outdoor spaces, consisting of all layers made over the ground or over a flat structural element, usually horizontally (inclined to ramps), with the aim of achieving a horizontal surface that meets the specific requirements for use.

1. **Raised floor** – independent floor, mounted over the structural floor; load-bearing systems placed on the market as kits (raised floors; cavities)

**59) Wall** – building element vertical or inclined to a maximum angle of  $10^{\circ}$  (general case) from vertical or maximum  $15^{\circ}$  in the case of curtain walls, between the floors of a building (Figure 22).



$\alpha \leq 15^{\circ}$ la pereți cortină	$\alpha \leq 15^{\circ}$ in curtain walls
$\alpha \leq 80^{\circ}$ sau $75^{\circ}$ (fațade cu pereți cortină)	$\alpha \leq 80^{\circ}$ or $75^{\circ}$ (curtain wall façades)
planșeu rezistent la foc	fire resistant floor
Notă: în cazul pereților cortină se consideră unghiul $\alpha$ atunci când $\alpha \leq 15^{\circ}$	Note: for curtain walls, the angle $\alpha$ is considered when $\alpha \leq 15^{\circ}$

**Figure 22 - Wall – tilt**

**60) Curtain wall** – a non-bearing outer wall anchored (attached) to the portable structure of the building, generally made up of a network of vertical profiles and horizontal profiles assembled together. A curtain wall includes uprights and beams, glazed element(s), opaque element(s), sealing, fasteners and movable components (windows or doors). The curtain wall is thus designed to have its own structure that transmits dead loads – permanent or static own/permanent static loads from own weight, imposed – temporary and dynamic loads generated by car traffic, etc. (dynamic variable short duration payloads from car traffic), environmental loads (wind, snow, etc.)/climate loads (wind, snow, temperature variations), earthquake induced loads transmitted to the main building structure/seismic loads. The curtain wall shall be carried out according to the specific regulation, the fire safety requirements shall be ensured according to the requirements of this Rule.

**61) External fire performance** – Conventional expression of the behaviour of a roof or roof covering when, under end-use conditions, it is exposed to a fire outside the construction.

External fire performance classification of roofs and roof coverings:

$B_{ROOF}(t1)$ ,  $F_{ROOF}(t1)$  where  $t1$  = Only burning bodies;

$B_{ROOF}(t2)$ ,  $F_{ROOF}(t2)$  where  $t2$  = Burning bodies + wind;

$B_{ROOF}(T3)$ ,  $C_{ROOF}(T3)$ ,  $D_{ROOF}(T3)$ ,  $F_{ROOF}(T3)$  where  $t3$  = Burning bodies + wind + radiation;

$B_{ROOF}(t4)$ ,  $C_{ROOF}(t4)$ ,  $D_{ROOF}(t4)$ ,  $E_{ROOF}(t4)$ ,  $F_{ROOF}(t4)$  where  $t4$  = Burning bodies + wind + additional radiation.

Notes:

- The European Commission has drawn up a list of products which, under certain conditions, can be classified as class  $B_{ROOF}$  without being tested. This information is set out in the Commission Decision of 6 September 2009, which sets out the list of products classified in classes  $B_{ROOF}$  (Decision 2000/553/EC – 2005/403/EC – 2006/600/EC).

- In addition, there was a procedure allowing certain products to be assigned a special fire classification without having to be tested. Such products shall have well-established reaction to fire performance and be approved by the Standing Committee on Construction. Approvals relating to these products, which can be 'classified without further testing' (CWFT<sup>N1</sup>), are published in the Official Journal of the EU.

<sup>N1</sup>) NATIONAL NOTE - CWFT Acronym comes from English, 'classified without further testing'.

- For the classification of a roof/roof covering only those test methods and application rules for which the appropriate classification is envisaged shall be applied.

- Products are analysed in relation to their end-use.

- Products classified in a given class shall be considered to meet all the requirements of any lower class for the same test method/fire hazard scenario.

- The external fire performance of a roof/roof covering depends not only on the intrinsic properties of its components and the conditions of fire action, but also to a large extent on the slope of the roof.

– Tests and scopes (according to SR EN 13501-5):

#### Test 2

- The standardised test slope shall be of 30°.

- The standardised sublayers are:

a) agglomerated wood plate (non-flame retardant), with a density of  $(680 \pm 50)$  kg/m<sup>3</sup> and a thickness of  $(19 \pm 2)$  mm;

b) expanded polystyrene (EPS) (non-flame retardant), with a density of  $(20 \pm 5)$  kg/m<sup>3</sup> and a thickness of  $(50 \pm 10)$  mm;

c) reinforced calcium silicate plate with density of  $(680 \pm 50)$  kg/m<sup>3</sup> and a thickness of  $(10 \pm 2)$  mm;

d) mineral wool, density of  $(150 \pm 20)$  kg/m<sup>3</sup> and thickness of  $(50 \pm 10)$  mm.

– Tests may be carried out with the end-use substrate, but in this case the test result obtained is applicable for this end-use only.

- Direct scope of test results:

a) The test results obtained with a slope of 30° shall be valid for all slopes.

b) The test results obtained for a roof covering fixed to a substrate shall only be applied for the roof covering on substrates having a density greater than or equal to 0.75 times the density used in the test.

c) The test results obtained on a standardised non-combustible substrate shall apply only to non-combustible substrates which also comply with the requirement in point (b).

d) The test results obtained on a standardised fuel substrate shall be applied for combustible and non-combustible substrates which also comply with the requirement in point (b).

e) The test results obtained on a non-standard substrate shall apply only for that substrate, which also complies with the requirement in point (b).

#### Test 3

- The standardised test slopes shall be of 5° and 30°. The tests may also be carried out with the actual expected slope. The classification thus obtained is only valid for that slope.

- Standardised supports are:

a) support of wooden particle board, constructed from boards 250 mm wide x 16 mm thick, having a density of  $(680 \pm 50)$  kg/m<sup>3</sup>, with straight edges and tightly joined side by side in such a way that the joints between the boards do not exceed 0.5 mm;



- b) support of planks made of particle wooden boards as in point a), straight edges, with joints of  $(5 \pm 0.5)$  mm;
  - c) reinforced calcium silicate plate support,  $(12 \pm 2)$  mm thick, with a dry density of  $(680 \pm 50)$  kg/m<sup>3</sup>;
  - d) steel support with trapezoidal profile;
  - e) without any continuous support.
- Tests may also be carried out with the support actually envisaged. The classification thus obtained is valid only for the tested support.

- Direct scope of test results:

1) Slope:

- The test results obtained on a 5° slope shall be applied to roofs with slopes < 10°.
- The test results obtained for a slope of 30° shall be applied to roofs with slopes > 10° and < 70°.
- The test results obtained for another specified slope shall apply only to roofs with that slope.

2) Type of support:

2.1) Test with standardised supports:

The test results obtained with standardised supports shall be applied to all systems with the same components (including thickness), mounted in the same way but with different supports, as follows:

a) The results of the test obtained with a support of particle boards of wood with positional joints not exceeding 0.5 mm shall be used in:

- any continuous support of wood with a thickness of not less than 12 mm and with joints not exceeding 0.5 mm;
- any continuous non-combustible support with a thickness of not less than 10 mm, without joints.

b) The test results obtained with a support of particle board of wood, with joints between boards of  $(5.0 \pm 0.5)$  mm, shall be used for:

- any continuous support of wood with a thickness of not less than 12 mm;
- any support made of wooden boards with smooth edges;
- any non-combustible support with joints not exceeding 5 mm.

c) The test results obtained with an reinforced calcium silicate plate shall be used for:

- any continuous non-combustible support with a thickness of not less than 10 mm.

d) The test results obtained with a trapezoidal steel support shall be used in:

- any support of profiled and non-perforated steel,
- any continuous non-combustible support with a thickness of not less than 10 mm.

e) The test results obtained without any continuous support shall only be used in systems without continuous support.

2.2) Test with other support:

Test results obtained with another substrate shall be used only for that roof system (e.g. composition, materials, dimensions of components and thickness are identical).

**Test 4**

- The standardised test slope shall be of 45°, unless the test pieces are flat roofs (with a slope of up to 10°) and must be tested horizontally. Tests can also be performed with the actual expected slope. The classification thus obtained is only valid for that slope.

- Nature of the support: the tests shall be carried out on a test piece with the complete roof structure, representative for the complete roof construction in final use, including the support and the effective supporting structure.

- Including joints: at least one of the test piece used in the penetration test shall include at least one example of joint into each layer of the roof system to be tested.

- Direct scope of test results:

1) Slope:

- a) The test results obtained with a slope of 0° (horizontal) are valid for flat roofs (with a slope of up to 10°)
- b) The test results obtained with a slope of 45° are valid for roofs with slopes greater than 10°.
- c) The test results obtained with another specified slope shall only apply to the respective slope roofs.

2) Nature of the support and support structure:

- The classification is valid only for the support structure tested. The rules for extending the scope are detailed in the standard **SR EN 13501-5**.

**62) Ceiling** – non-structural building element representing a horizontal area or inclined/separation of a space/plenum with technical or non-technical destination, positioned under a floor, roof or other structural element. The ceiling may be self-supporting (fixed on the contour, without further supporting) or suspended (fixed directly or at any distance from the floor, roof).

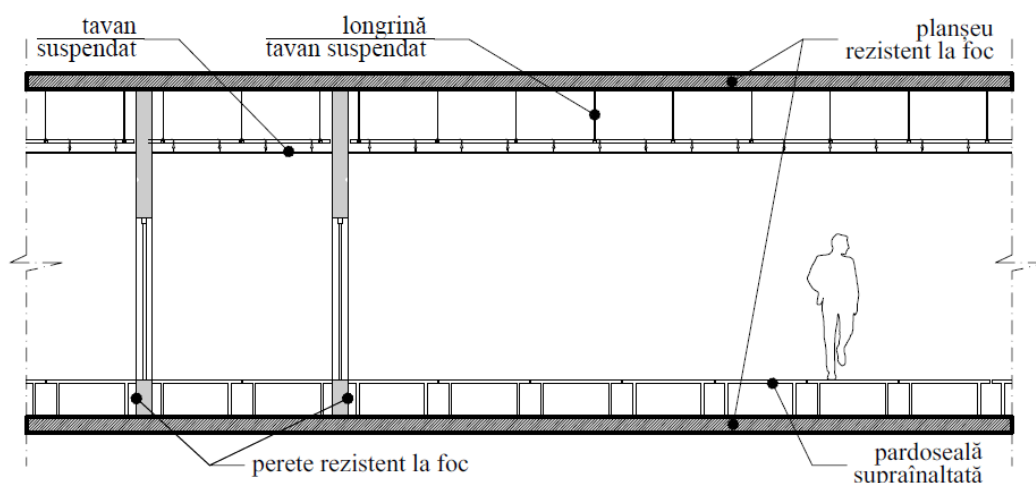
1. – **(suspended) ceiling** – ceiling suspended by the structural component of the construction, including the mounting structure and when provided, the insulating material
2. – **ceiling system** – complete assembly of a tested roof, including the fastening structure and e.g. luminaires, access panels, etc.

**63) Floor** – a structural building element, horizontal or inclined, delimiting any 2 levels of construction.

**64) Platform** – a horizontal building element full or perforated not exceeding 50 %, intended for access and occasional traffic up to 8 times per shift (no permanent place of activity). Platforms shall not be taken into account when determining the level of fire stability and the number of construction levels.

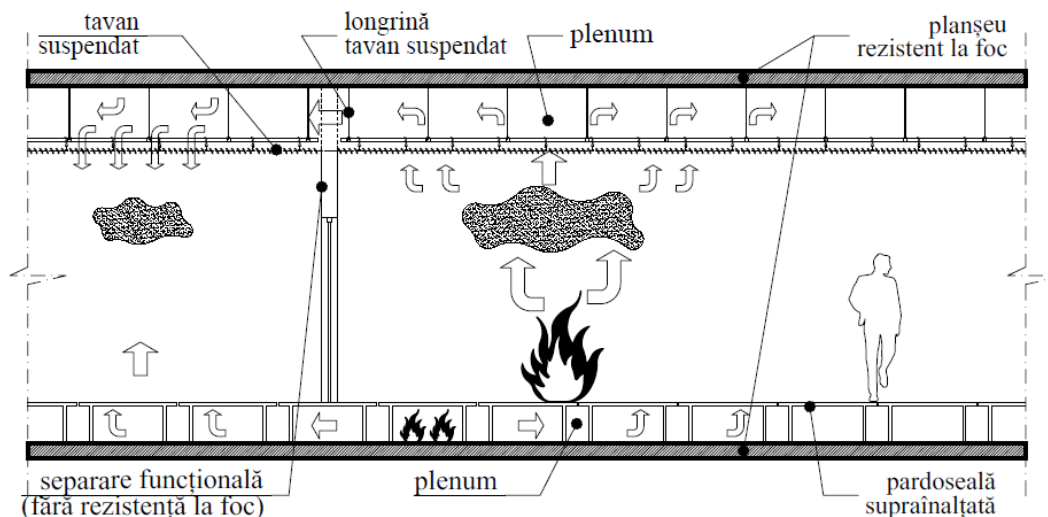
**65) Outdoor platform** – open construction for the storage of materials/machinery.

**66) Plenum** – space bounded by a raised floor and floor and/or a suspended ceiling and floor (Figure 23)

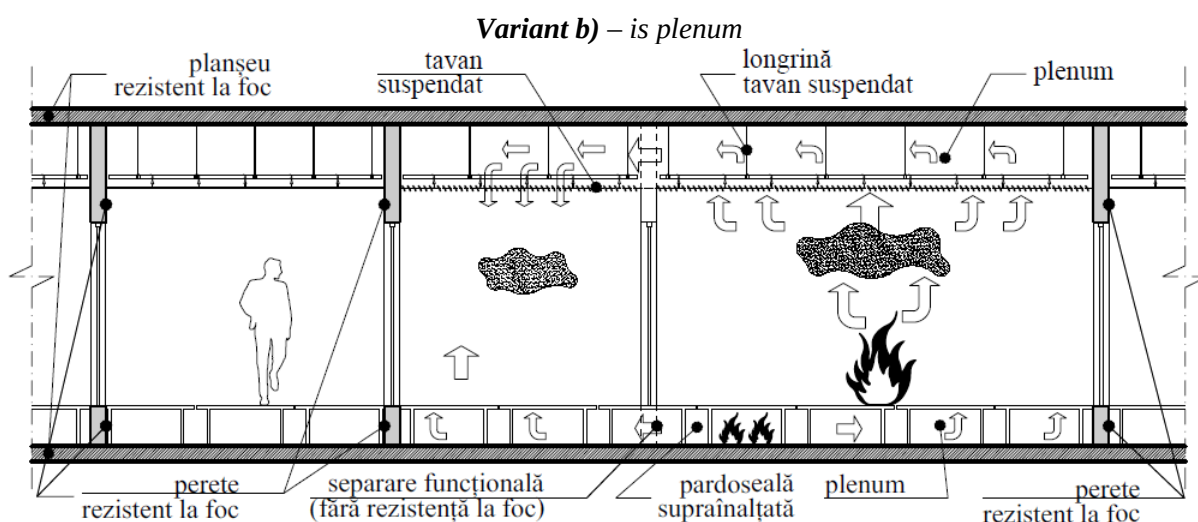


tavan suspendat	suspended ceiling
longrină tavan suspendat	suspended ceiling longitudinal beam
planșeu rezistent la foc	fire resistant floor
perete rezistent la foc	fire resistant wall
pardoseală supra înălțată	elevated floor covering

**Variant a)** – not plenum



tavan suspendat	suspended ceiling
longrină tavan suspendat	suspended ceiling longitudinal beam
plenum	plenum
planșeu rezistent la foc	fire resistant floor
separare funcțională (fără rezistență la foc)	functional separation (without resistance to fire)
pardoseală supraînălțată	elevated floor covering



planșeu rezistent la foc	fire resistant floor
tavan suspendat	suspended ceiling
longrină tavan suspendat	suspended ceiling longitudinal beam
plenum	plenum
perete rezistent la foc	fire resistant wall
separare funcțională (fără rezistență la foc)	functional separation (without resistance to fire)
pardoseală supraînălțată	raised floor

**Variant c) – plenum delimitation with fire resistant walls**

**Figure 23 - Plenum for open spaces**

67) **Attic** – constructed volume without functions, not heated, between the last floor of the construction and the covering of its framing-type roof.

68) **Product** – material, element or component on which information is required  
**1.Homogeneous product** – product consisting of a single material, having uniform

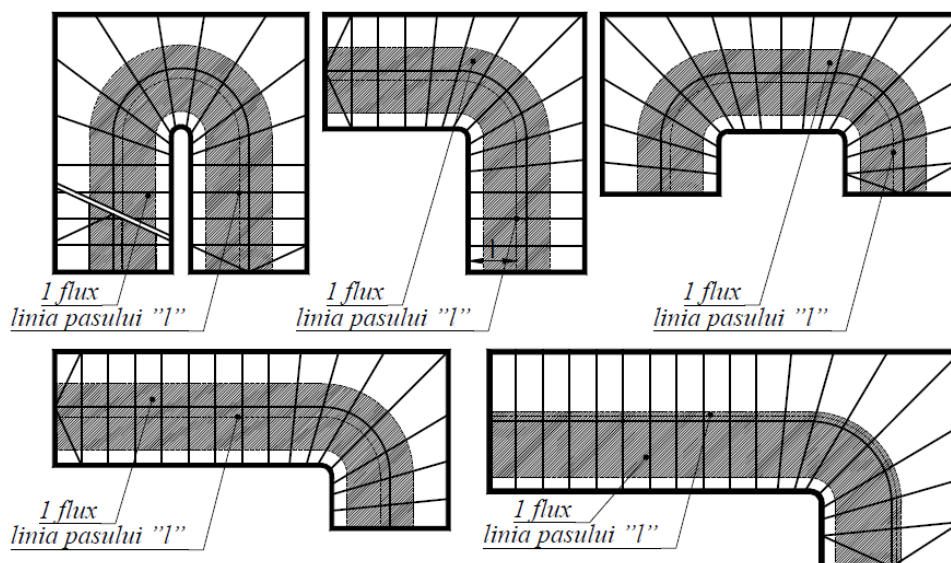
density and composition throughout the product

2. **Non-homogeneous product** – product which does not satisfy the requirements for a homogeneous product. It is a product made of one or more components, substantial and/or non-substantial.

3. **Heat-insulating product for linear tubing** – length of insulation product designed to be mounted around ducts with a maximum external insulation diameter of 300 mm.

- 69) **Fire protection** – method used to reduce the spread and effects of fire
1. **Active fire protection** – method(s) used to reduce or prevent the propagation or effects of fire, heat or smoke by fire detection and/or extinguishing and requiring some action or response to become active.
  2. **Passive fire protection** – method used to reduce or prevent the propagation and effects of fire, heat and smoke through the appropriate design, use, protection and location of construction products and elements and their constituent materials and/or the appropriate use of materials and which do not require detection and/or activation as a result of detection.
- 70) **Reaction to fire** – the behaviour of a product which, under specified conditions, fuels by its own decomposition a fire to which it is exposed.
- 71) **Fire risk** – estimate of expected loss due to a fire, which combines the potential damage associated with the different fire scenarios that may occur and the probabilities that these scenarios will occur (An alternative definition for fire risk is “the combination of the probability of a fire and the quantified measure of its consequences”. The fire risk is often calculated as the product of probability and consequences).
- 72) **Fire resistance** – the suitability of a product/component of construction to fulfil the function or functions required by performance criteria (and/or load-bearing capacity and/or tightness and/or thermal insulation to fire; e.g. R, REI, RE, EI, etc.), for a fixed period of time and/or any other function, determined in a standardised fire resistance test or calculation models in standards **SR EN 1991-1-2, SR EN 1992-1-2, SR EN 1993-1-2, SR EN 1994-1-2, SR EN 1995-1-2, SR EN 1996-1-2** and **SR EN 1999-1-2**, together with their amendments, errata and national annexes.
- 73) **Agglomerated room** - independent construction or room/group of rooms that communicate directly with each other through gaps (protected or unprotected) in partitions and in which at least **200** users may meet simultaneously at the level(s) from which direct escape can be made at the elevation of the reference level or **150** at other levels of construction from which it the escape cannot be made directly at the elevation of the reference level, and the area of the floor covering a person being less than or equal to **4 m<sup>2</sup>**.
1. **Crowded rooms** – see ‘Human agglomeration rooms’
- 74) **Thermal load** – heat that can be produced by fully burning all combustible materials and products within an enclosure, including building elements and built surface finishes (expressed in MJ).
- 75) **Escape staircase** – vertical path (carried out according to specific regulations) closed or opened, suitably arranged, made up, compliant, dimensioned and protected according to the provisions of the Rule, so as to ensure adequate conditions for the safe escape of users in the event of fire.

76) **Staircase with swinging steps** - staircase (constructed according to the specific regulation and Figure 24) where the shape of some steps in the plane is different from the other steps (in the height of one or more ramps).



1 flux linia pasului „1”	1 flow step line ‘1’
--------------------------	----------------------

**Figure 24 - Staircase with swinging steps**

(‘Step line – line on which the width of steps “L” is measured in the horizontal projection and showing graphically the direction of climb’ according to the specific regulation)

Note to Figure 24: Staircases with swinging steps can only be considered as escape routes for one (1) user escape (flow) unit, when they meet the composition and dimensioning conditions laid down in the Rule and technical regulations specific to stairways (in the part of the ramp where the minimum width of the step is **18 cm** and maximum width of **40 cm**).

77) **Monumental staircase** – staircase which aims to achieve a particular architectural effect, so as to ensure (where appropriate) escape in the event of danger.

78) **Fire safety scenario** – terminology that differs from the ‘fire scenario’ – part of the written parts of the construction or development design, summarising the fire defence rules and measures established by the technical design/construction documents drawn up in order to ensure the safety of users and property.

79) **Scene developed** – play space for theatre, with a minimum area of **150 m<sup>2</sup>** (including pockets and its warehouses), fitted with theatrical tower, with or without floor hatches and equipped with decoration handling devices.

80) **Smoke and hot gas exhaust system** – a system for limiting the spread of fire in buildings, consisting of smoke and hot gas exhaust devices arranged in the roof or in the upper third of the external walls, as well as continuous vertical screens arranged under the floors or roof, with air intakes located on the side bottom of that space.

**Smoke and hot gas exhaust system (SHEVS – pressurisation system)** – system in which components are jointly selected to evacuate smoke and hot gases to establish a floating layer of hot gases above the colder and cleaner air

**Pressurisation** – smoke control using pressure differences between the protected space and the unprotected space, with higher pressure in the protected space

**Differential pressure system (PDS)** – combination of at least one kit and additional components intended to produce pressure differential and air flow between protected and unprotected spaces

**81) Solar systems** – For the purposes of this Rule, this expression includes both photovoltaic installations and solar thermal installations.

**Photovoltaic system (PV)** – Device that directly converts solar radiation into electricity using photovoltaic cells.

**Integrated photovoltaic system (BIPV)** – facade or roof integrated system (functional part of the building envelope) that has to comply with **IEC 61730-2: 2016** (fire resistance and ignition rules for photovoltaic modules) and construction standards for fire safety defined according to the installation category of BIPV modules included in facades according to **SR EN 50583**

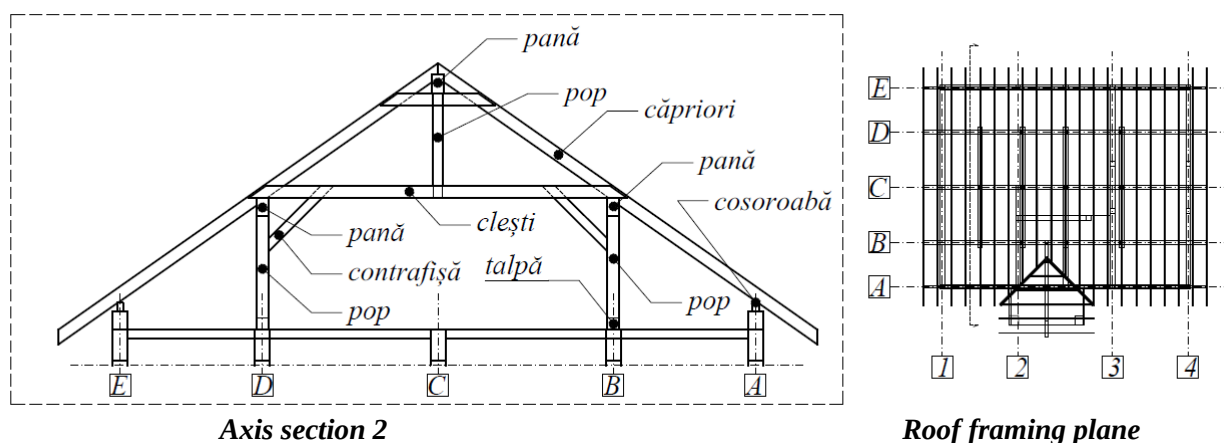
**82) Floating structure** – structure where the structural shape of the membrane is provided by air-pressurised elements and users use unpressurised space.

**83) Pressurised structure** – structure where the structural form is provided by air pressure and users use pressurised space.

**84) Associated structures** – constructions built in the proximity of the tents they serve functionally, such as kitchens, toilets, furniture warehouses, wardrobes, caravans

**85) Intermediate floor** – partially full floor, open on one or more sides of the room in which it is arranged. Intermediate floors (partial floors), occupying more than **40 %** of the area of the room in which they are arranged, shall be considered as levels and shall be taken into account when determining the level of fire stability of the construction.

**86) Roof framing** – the inclined structural assembly of the roof of a building, on which the cover support and covering or covering boards are provided (Figure 25).



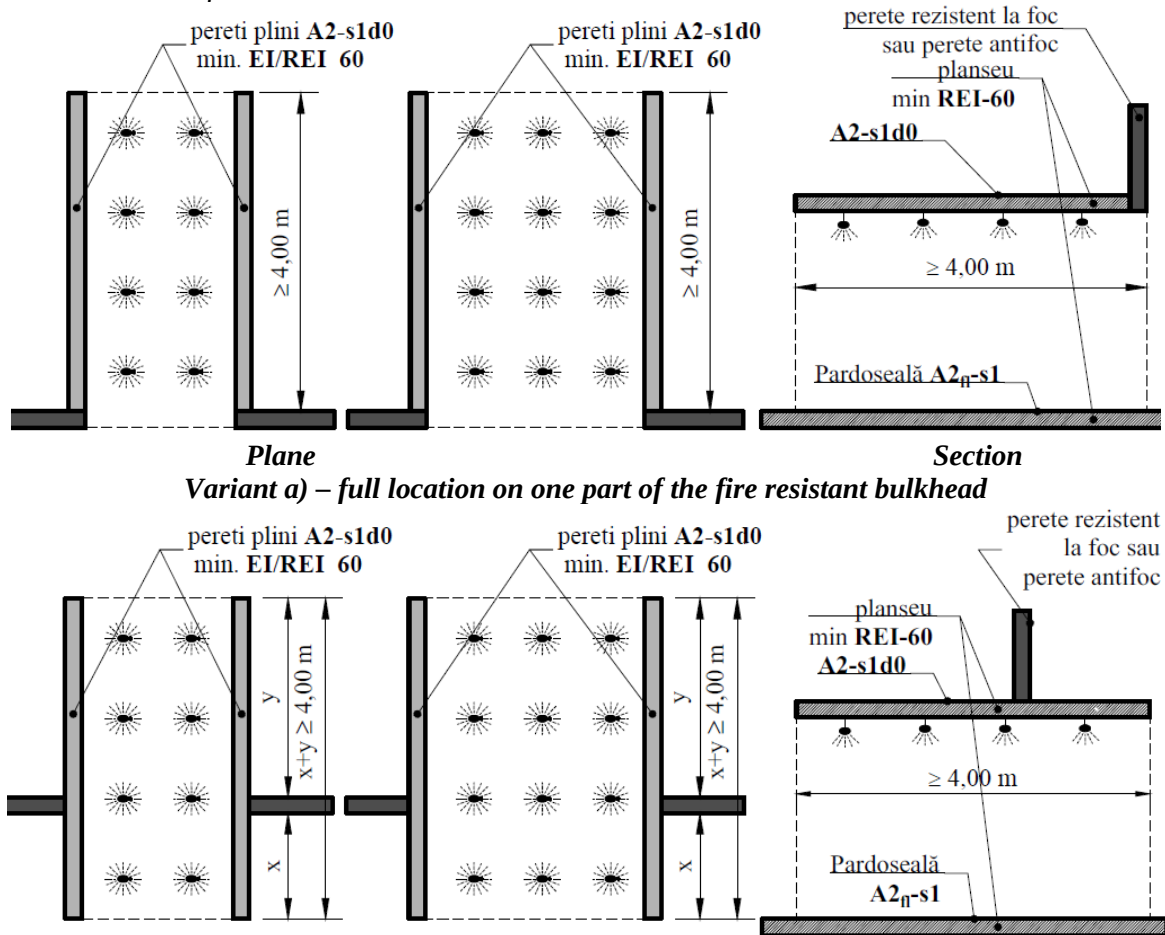
pană	purlin
pop	prop
căpriori	rafters
pană	purlin
cosoroabă	wall plate
pană	purlin
contrafișă	cantilever
pop	prop
clești	pliers
talpă	foot
pop	prop

**Figure 25 - Roof framing- components**

**87) Basement** – a constructed level of the construction with the floor below the level of the land (roadway) adjacent to more than half its clear height. Basements shall be included in the number of underground construction levels.

Note: see definition ‘semibasement’ and Figure 11 (semibasement).

**88) Open tambour** – system for the protection of joint functional and escape circulation gaps from fire walls or fire resistant walls (Figure 26), when technically justified, doors or buffer rooms cannot be used. One sprinkler head is provided for each 1 m<sup>2</sup> of horizontal tambour surface.



pereti plini A2-s1d0 min. EI REI 60	solid walls A2-s1d0 min. EI REI 60
perete rezistent la foc san perete antifoc planseu min REI-60	fire resistant wall or fire wall floor
min REI-60	min. REI-60
Pardoseală A2 <sub>n</sub> -s1	Floor covering A2 <sub>n</sub> -s1

**Figure 26 - Open tambour**

**89) Fire resistant doors, curtains and shutters** – movable voids protection elements (functional or non-functional use) of building elements intended to limit the spread of fire, which are made up and equipped according to the provisions of the Rule.

**90) Escape doors** – movable components with normal opening, on hinges or pivots, or hinges or pivot doors equipped with locking systems and exit devices enabling them to be

removed from the inside, even if they are locked by key, by simply pressing on the handle, or automatic break-out doors or redundant automatic sliding doors, or revolving doors with the possibility of lightweight folding of door sheets, thereby ensuring the free width required for evacuation, or other types of doors provided for in the Rule, used to close gaps in walls and intended for the functional and escape circulation of users.

Note 1: The fitting of doors with panic exit devices or emergency exit devices is laid down in the Rule.

Note 2: May be regarded as escape doors and other doors provided that they comply with the terms and conditions laid down and are intended solely for the purpose and conditions laid down by the Rule.

- a) **Escape door with normal opening** – moveable normal opening on hinges or pivots, not equipped with a locking system.
- b) **Escape door equipped with locking system and exit device** – hinged door or pin equipped with locking system and exit device enabling it to be opened from the inside, even if it is locked by key, by simply pressing on the handle, used to close the gaps in the walls and intended for the functional and escape circulation of users.
  - When the escape door with hinges or pivots is located in an area with public access (visitors), the door shall be equipped with a mechanically operated panic exit device, either by a horizontal pushing bar or by a horizontal drawbar, as an actuator on the inner face, and hereinafter referred to as: **panic door** (SR EN 1125).
  - When the escape door with hinges or pivots is located in an area without access to the public, but only with persons who know both the typology of the building (without visitors) and the functions of the escape door, the door shall be equipped with a mechanically actuated emergency exit device either by a groove handle (complying with the requirements of SR EN 179) or by a pushing plate on the inner face and hereinafter referred to as a door by **emergency exit** (SR EN 179).
- c) **Automatic sliding break-out escape door** – sliding door operated by a complete automation system which, in addition to the sliding movement for automatic opening by the presence sensor, also has the possibility to open revolving by pushing the wings by the flow of persons and folding them (the wings) towards the escape direction.
- d) **Automatic sliding escape redundant door** – a door operated by a complete automation system in which for each essential component equipment (engine, processor, motion detector, accumulator) there is a reserve to ensure that in the event of a power failure, defect or fire, the sliding door will open automatically safely without the need for mechanical operation.
- e) **Revolving escape door** – a door with the possibility of folding door sheets by which folding shall ensure the number of flows.

91) **Users** – persons and animals using the construction;

92) **Volume** – product of area and height

1. **Level volume ( $V_{niv}$ )** - Volume obtained from the product between the area of the level and its height, determined according to **STAS 4908** Non industrial, industrial and agricultural buildings. Conventional areas and volumes. The volume of air in the room shall be related to the inner faces, representing the volume obtained from the product of the room area and its height.



2. **Total volume ( $V_t$ )** – Sum of levels volumes according to **STAS 4908** – Non industrial, industrial and agricultural buildings. Conventional areas and volumes, in relation to the external contours of the construction.

## CHAPTER 2

### 2. COMMON PERFORMANCE TO BUILDINGS FOR ANY PURPOSE (CIVIL, PRODUCTION AND/OR STORAGE)

#### SECTION I

#### 2.1. GENERAL CONDITIONS FOR THE PERFORMANCE OF CONSTRUCTIONS

##### 2.1.1. General provisions

**Article 2.1.1.1.** The performance, performance levels and safety conditions in the event of fire of constructions for any purpose (civil, production and/or storage, mixed) shall be established by design and carried out according to the provisions of the Rule and shall be specified in appropriate documentation:

- a) the category and class of importance of construction;
- b) the destination, type of construction and maximum simultaneous capacity of users;
- c) risks of fire in rooms, fire compartments and construction;
- d) the fire stability level of the construction (fire compartment), so as to ensure that the standard correlation conditions are met;
- e) the conditions specific to the intended use of the construction (fire compartment);
- f) access possibilities, for intervention and rescue in the event of fire.

**Article 2.1.1.2.** The importance category and the importance class of the construction shall be determined according to the legal provisions.

**Article 2.1.1.3.** The intended use of the construction, fire compartments, rooms and, where appropriate, its spaces, as well as the type of construction and maximum simultaneous user capabilities, shall be specified in the documentation in order to establish and carry out the normal fire safety measures.

##### 2.1.2. Fire risk

**Article 2.1.2.1.** (1) The fire risks and, where appropriate, the hazard of a volumetric explosion, shall be determined and reported for each room (in particular cases and zones thereof), the fire compartment and the entire construction, depending on the density of the heat load (**q**) and the respective functions (taking into account the most restrictive value), according to the provisions of the Rule.

(2) For constructions of production and/or storage, the fire risk may also be determined by zones.

(3) The technical design and construction documentation shall specify the fire risk of rooms, zones, fire compartments and buildings, and where there is also a volumetric explosion risk, its protection zones shall also be specified.

(4) The fire risk of the whole construction/fire compartment shall be determined by summing the heat load determined for each room/zone and reported to the developed area.

**Article 2.1.2.2. (1)** Depending on what is specified in Article 2.1.2.1., the fire risk may be considered as:

- a) – **low risk**, when the density of the heat load (**q**) is maximum **420 MJ/m<sup>2</sup>**;
- b) – **medium risk**, when the density of the heat load (**q**) is greater than **420 MJ/m<sup>2</sup>** and maximum **840 MJ/m<sup>2</sup>** or open fire in any form shall be used;
- c) – **high risk**, when the density of the heat load (**q**) is greater than **840 MJ/m<sup>2</sup>** and maximum **1 680 MJ/m<sup>2</sup>**;
- d) – **very high risk**, when the density of the heat load (**q**) is greater than **1 680 MJ/m<sup>2</sup>** and/or there is a risk of volumetric explosion.

**(2)** Density of heat load (**q**) shall be determined by calculation, taking into account all fixed and movable combustible products, materials and substances used, processed, handled or stored in rooms, fire and construction compartments.

**(3)** Heat load for different materials can be found in *Annex 'Lower calorific values'*.

**Article 2.1.2.3. (1)** As a general rule, the fire risk of the room shall be determined by determining the density of the heat load, i.e. by summing the heat load determined for each zone of the room and referring to the useful area. As an exception, the highest fire risk of a zone not separated with fire resistant walls (**EI**, where applicable, **REI**) and fire resistant floors (**REI**), determine the fire risk of the entire room in which it is situated, when:

- a) the zone of high or very high fire risk, without a volumetric explosion hazard, has an area greater than **10 %** of the area of the room in which it is located or exceeds the area of **400 m<sup>2</sup>**;
- b) the very high fire risk zone with a volumetric explosion hazard has a larger volume than **5 %** of the volume of the room in which it is located;

**(2)** In cases where the highest risk zones have values below the conditions specified in points **a)** and **b)**, the lower fire risk (meeting those conditions) arising from the calculation of the thermal load density shall be adopted in the room and appropriate technical protection measures shall be taken in zones of higher fire risk or volumetric explosion risk (including their protection zones) in order to reduce the possibilities for slight spread of fire to neighbouring zones and the formation of local concentrations at risk of volumetric explosion.

**(3)** When there are more than one fire risk and/or volumetric explosion zones situated in distinct points/areas of a room (unseparated zones with fire resistant walls and floors), the fire risk of the entire room shall be determined as follows:

- a) – when the distance between those zones (measured horizontally) is less than **40 m**, the highest existing fire risk and the sum of its actual areas, i.e. the sum of volumes of the risk of volumetric explosion, shall be taken into account;
- b) – when the distance between those zones is greater than **40 m**, the actual areas shall not be summed up and shall be locally ensured (for each zone of fire or volumetric explosion hazard), the fire safety conditions and measures appropriate to that risk.

**Article 2.1.2.4.** The fire risk per fire/construction compartment shall be considered the highest risk of rooms and zones:

- a) of which the summed volumes represent more than **30 %** of the volume of the construction or fire compartment, regardless of their intended purpose, if they are zones of very high fire risk with a volumetric explosion hazard;
- b) whose summed areas is more than **30 %** within the developed area of the construction or fire compartment, regardless of their intended purpose

**Article 2.1.2.5. (1)** When determining the fire risks in zones, spaces, rooms, fire compartments and constructions in which production and/or storage activities are carried out,

account shall be taken of the provisions of **Annex** on ‘*Characteristics of substances and materials which give rise to the classification of spaces, rooms, fire compartments and production and/or storage buildings as a fire risk*’ and the preceding articles, the physical chemical characteristics specified in the safety data sheets of the material being transported, stored or stored must be taken into account.

(2) Storage of combustible or non-combustible materials and substances in production rooms shall be permitted only in the quantities and categories technologically necessary for a single work exchange.

**Article 2.1.2.6.** In determining the concentrations of mixtures at risk of volumetric explosion, account shall be taken of leaks and releases of possible gases, vapours or dust during normal activity. The demarcation of zones where the specific fire safety measures required by volumetric explosion hazards are ensured shall be mandatory and shall consider the possibility of air mixtures with gases, vapours or dust in concentrations with explosion hazard during normal operation.

### 2.1.3. Fire stability level of the construction

**Article 2.1.3.1.** (1) The level of fire stability shall be such that the construction or fire compartment meets the standard conformation and correlation requirements, taking into account the fire resistance classes of the main building elements used.

(2) The reaction to fire classes of products, materials and constructional elements used must be taken into account, which shall be mandatory:

- a) in high, very high civil buildings or with crowded rooms, in crowded rooms and where the Rule provides for requirements in this respect;
- b) in finishes of the escape routes of users of above-ground or underground constructions of any type and destination;
- c) in the situations specified in the applicable Rule or technical regulations.

**Article 2.1.3.2.** The minimum fire resistance requirements to be met by the main components of construction used to classify the construction or fire compartment to a certain level of fire stability are given in Table 2 and Table 3.

**Table 2: Minimum conditions for classifying the construction or fire compartment in civil buildings fire stability levels**

Current No	Type of construction elements used	Fire stability level of the construction/fire compartment										
		I h ≥ 125 m	I 75m≤ h <125 m	I 45 m ≤ h < 75m	I 28m< h<45 m	I h≤28 m	II	II (+)	III	III (+)	IV	V
1	POLES (R)	240 (A1)	180 (A1)	180 (A1)	120 (A1)	120 (A1)	120 (A1)	90	60	45	30	- (15 **)
2	BEAMS (R)	180 (A1)	120 (A1)	120 (A1)	90 (A1)	90 (A1)	90 (A1)	90	60	45	30	- (15 **)
3	floors, including floors – terrace constituting escape routes or taking on additional loads other than snow only (REI) loads	120 (A1)	120 (A1)	120 (A1)	90 (A1)	90 (A1)	90 (A1)	90	60	45	30	- (15 **)
4	terrace floors that do not constitute escape routes or take charge from snow only) (RE)	120 (A1)	90 (A1)	90 (A1)	60 (A1)	60 (A1)	60 (A1)	45	45	30	15	-

C	Type of construction elements used	Fire stability level of the construction/fire compartment											
		I h ≥ 125 m	I 75m≤ h <125 m	I 45 m ≤ h < 75m	I 28m< h<45 m	I h≤28 m	II	II (+)	III	III (+)	IV	V	
5	LOAD BEARING WALLS (STRUCTURAL) limiting the spread of fire (REI)	240 (A1)	180 (A1)	180 (A1)	120 (A1)	120 (A1)	120 (A1)	90	60	45	30	- (15* *)	
6	Walls for containment of fire propagation (fire protection limiting propagation inside fire compartments) (REI/EI)	180 (A1 or A2-s1, d0)	180 (A1 or A2-s1, d0)	120 (A1 or A2-s1, d0)	120 (A1 or A2-s1, d0)	120 (A1 or A2-s1, d0)	90 (A1 or A2-s1, d0)	90	60	45	30	- (15 **)	
7	Internal non-load bearing partition walls limiting the propagation of fire (EI)	90 (A1 or A2-s1, d0)	60 (A1 or A2-s1, d0)	60 (A1 or A2-s1, d0)	60 (A1 or A2-s1, d0)	60 (A1 or A2-s1, d0)	45 (A1 or A2-s1, d0)	45	30	15	15	-	
8	Non-load bearing external walls (excluding joinery panels, curtain walls, ventilated facades, double skin facades) (E 'o ↔ i')	60 (A1 or A2-s1, d0)	45 (A1 or A2-s1, d0)	30 (A1 or A2-s1, d0)	30 (A1 or A2-s1, d0)	15 (A1 or A2-s1, d0)	15 (A1 or A2-s1, d0)	15 (A1 or A2-s1, d0)	15	15	-	-	
9	Roof framings, self-supporting roofs (domes, cross-linked space structures, etc.) (R)	120 (A1)	90 (A1)	90 (A1)	60 (A1)	60 (A1)	60 (A1)	45	45	30	15	-	
10	Slope roof panels/roofs covering systems defined according to terminology (*)	a. with wind and snow loads (E)	60 (A1 or A2-s1, d0)	45 (A1 or A2-s1, d0)	45 (A1 or A2-s1, d0)	30 (A1 or A2-s1, d0)	30 (A1 or A2-s1, d0)	30 (*) (min B-s2, d0)	30 (*) (min B-s2, d0)	15 (*) (min C-s3, d0)	15 (*) (min C-s3, d0)	(*) (min D-s3, d0)	(*) (minD -s3, d1)
		b. with additional loads from photovoltaic	(***) B <sub>ROOF</sub> (T4)	(***) B <sub>ROOF</sub> (T4)	(***) B <sub>ROOF</sub> (T4)	(***) B <sub>ROOF</sub> (T4)	(***) B <sub>ROOF</sub> (T3)	(***) B <sub>ROOF</sub> (T3)	(***) B <sub>ROOF</sub> (T3)	(***) B <sub>ROOF</sub> (T3)	(***) B <sub>ROOF</sub> (T3)	(***) C <sub>ROOF</sub> (T3)	(***) C <sub>ROOF</sub> (T3)
		c. c1) with other loads except for those in point (a) and (b): (E) and for loads, an own structure having the fire performance set out in point 9 shall be provided, discharging directly on the roof framing (R). c2) (EER) when discharging is done directly on panels/	90 (A1 or A2-s1, d0)	60 (A1 or A2-s1, d0)	45 (A1 or A2-s1, d0)	45 (A1 or A2-s1, d0)	45 (A1 or A2-s1, d0)	30 (*) (min B-s2, d0)	30 (*) (min B-s2, d0)	15 (*) (min C-s3, d0)	15 (*) (min C-s3, d0)	(*) (min D-s3, d0)	(*) (minD -s3, d1)

C	Type of construction elements used	Fire stability level of the construction/fire compartment										
		I h ≥ 125 m	I 75m≤ h <125 m	I 45 m ≤ h < 75m	I 28m< h<45 m	I h≤28 m	II	II (+)	III	III (+)	IV	V
	covering systems;											

**Notes:**

(+) Construction works equipped with automatic sprinkler/spray fire-extinguishing systems in addition to the requirements of the specific technical regulations.

(\*) In buildings equipped with sprinkler or water mist fire-extinguishing systems, with the exception of those not covered by level I of stability, the condition of being classified to the fire stability level shall be deemed to be satisfied if the covering system is composed of:

- trapezoidal steel layer of thickness equal to or exceeding **1.00 mm**;
- vapour barrier having less than **11.6 MJ/m<sup>2</sup>**, lower thickness of **1.00 mm** and mass per unit of area less than **1 kg/m<sup>2</sup>**;
- thermal insulation with a minimum thickness of **20 cm**, reaction class to fire **A1**, minimum density **150 kg/m<sup>3</sup>**;
- hydro insulating membrane only required to meet the external fire performance class, as follows: minimum **B<sub>ROOF(T3)</sub>** for level **II** and **III** of fire stability or **C<sub>ROOF(T3)</sub>** for level **IV** of fire stability.

(\*\*) Shall constitute an exemption from classification under conditions ‘no fire determined performance’ **Note (3) of Table 42: Conditions for correlation between destination, simultaneous maximum capacity and number of above-ground levels of civil buildings with fire stability level III, IV or V for fire stability level V.**

(\*\*\*) Insurance is compulsory and **minimum** the conditions laid down for standardised panel supports or roofing systems provided for in **Reference No 10 point b).**

‘-’ = no fire determined performance

‘h’= elevation of the last accessible/usable floor of the construction from the reference level

In order to verify the fire resistance requirements of secondary structural elements, the designer shall verify that the collapse of these elements by the effect of fire will not compromise: the bearing capacity of other structural elements forming part of the structure (in fire conditions), the effectiveness of subdivision of structural elements, the operation of active fire protection systems, the safe escape of users and the safety of the intervention teams.

**Table 3: Minimum conditions for the classification of the construction or fire compartment into fire stability levels for production and/or storage buildings**

Reference No	Type of construction elements used	Fire stability level of the construction/compartment					
		I	II	II (+)	III	IV	V
1	POLES (R)	180 (A1)	120 (A1)	90 (A1)	60	30/(**)	-
2	BEAMS (R)	120 (A1)	90 (A1)	90 (A1)	60	30/(**)	-
3	floors, including floors – terrace constituting escape routes or taking on additional loads other than snow only (REI) loads	120 (A1)	90 (A1)	90 (A1)	60	30	-
4	terrace floors that do not constitute escape routes or take charge from snow only) (RE)	60 (A1)	45 (A1)	45 (A1)	30	15	-
5	LOAD BEARING WALLS (STRUCTURAL) limiting the spread of fire (REI)	180 (A1)	120 (A1)	90 (A1)	60	30/(**)	-
6	Walls for containment of fire propagation (for protection against fire limiting propagation inside fire compartments) (REI/EI)	120 (A1 or A2-s1, d0)	120 (A1 or A2-s1,d0)	90 (A1 or A2-s1, d0)	60	30/(**)	-

Reference No.	Type of construction elements used	Fire stability level of the construction/compartment						
		I	II	II (+)	III	IV	V	
7	Internal non-load bearing partition walls limiting the propagation of fire (EI)	60	45	45	30	15	-	
8	Non-supporting external walls (excluding joinery panels, curtain walls, ventilated facades, double skin facades). (E)	30 (A1 or A2-s1, d0)	15 (B-s1d0)	15 (B-s2d0)	15	-	-	
9	Roof framings, self-supporting roofs (domes, cross-linked space structures, etc.) (R)	60 (A1)	45 (A1)	45 (A1)	30	15	-	
10	Slope roof panels/roofs covering systems defined according to terminology (*)	a. with wind and snow loads (E)	30 (A1or A2-s1, d0)	30 (*) (min B-s2, d0)	15 (*) (min B-s2, d0)	15 (*) (min C-s3, d0)	15 (*) (min C-s3, d0)	(*) (min D-s3, d0)
		b. with additional loads from photovoltaic	(***) B <sub>ROOF</sub> (T4)	(***) B <sub>ROOF</sub> (T3)	(***) B <sub>ROOF</sub> (T3)	(***) B <sub>ROOF</sub> (T3)	(***) C <sub>ROOF</sub> (T3)	(***) D <sub>ROOF</sub> (T3)
		c) c1) with other loads except for those in point (a) and (b): (E) and for loads, an own structure having the fire performance set out in point 9 shall be provided, discharging directly on the roof framing (R); c2) (REI) when discharging is done directly on panels/covering systems.	60 (A1or A2-s1, d0)	45 (*) (A1or A2-s1, d0)	30 (*) (min B-s2, d0)	30 (*) (min C-s3, d0)	15 (*) (min C-s3, d0)	(*) (min D-s3, d0)

**Notes:**

(+) Construction works equipped with automatic sprinkler/spray fire-extinguishing systems in addition to the requirements of the specific technical regulations.

(\*) In buildings equipped with sprinkler or water mist fire-extinguishing systems, with the exception of those not covered by level I of stability, the condition of being classified to the fire stability level shall be deemed to be satisfied if the covering system is composed of:

- trapezoidal steel layer of thickness equal to or exceeding **1.00 mm**;
- vapour barrier having less than **11.6 MJ/m<sup>2</sup>**, lower thickness of **1.00 mm** and mass per unit of area less than **1 kg/m<sup>2</sup>**;
- thermal insulation with a minimum thickness of **20 cm**, reaction class to fire **A1**, minimum density **150 kg/m<sup>3</sup>**;
- hydro insulating membrane only required to meet the external fire performance class, as follows: minimum **B<sub>ROOF</sub>(T3)** for level **II** and **III** of fire stability or **C<sub>ROOF</sub>(T3)** for level **IV** of fire stability.

(\*\*) An exception shall be made for production-storage structures with a low and medium fire risk ground floor where the structure (poles, beams, structural walls) may have fire resistance of **15 minutes**.

(\*\*\*) Insurance is compulsory and **minimum** the conditions laid down for standardised panel supports or roofing systems provided for in **Reference No 10 point (b)**:-

‘-’ = no fire determined performance

*'h'* = elevation of the last accessible/usable floor of the construction from the reference level

*In order to verify the fire resistance requirements of secondary structural elements, the designer shall verify that the collapse of these elements by the effect of fire will not compromise: the bearing capacity of other structural elements forming part of the structure (in fire conditions), the effectiveness of subdivision of structural elements, the operation of active fire protection systems, the safe escape of users and the safety of the intervention teams.*

**Article 2.1.3.3.** (1) The fire stability level of the construction or fire compartment shall be determined by its element with the most unfavourable classification.

(2) In high, very high buildings and congested rooms with level **I** of fire stability, roof framing with or without an attic shall be made entirely of materials and elements of the reaction to fire class **A1**, and in crowded rooms with level **II** of fire stability may be a minimum according to Table 2, i.e. minimum **C-s1d0** for those with the level **III** of fire stability (fitted with automatic extinguishing system).

(3) The protection of metallic structures against thermal fire actions (thermal foaming paint, jetcrete protection, cladding or other systems) shall correspond to the critical temperatures of the respective structures and section factors.

(4) In the absence of a specific calculation, the value of the critical temperature for steel elements with cross-section of class **1, 2 and 3** used in buildings may be considered equal to **500 °C** and for steel parts with cross-section of class **4** to be established according to the national annex to **SR EN 1993-1-2**.

(5) The technical and economic documentation shall specify the level of fire stability of the construction and, where applicable, the fire compartment.

**Article 2.1.3.4.** When determining the level of fire stability of the construction or fire compartment, the following shall not be taken into account:

**a)** roof framing and support of covering to construction with attic (Figure 27):

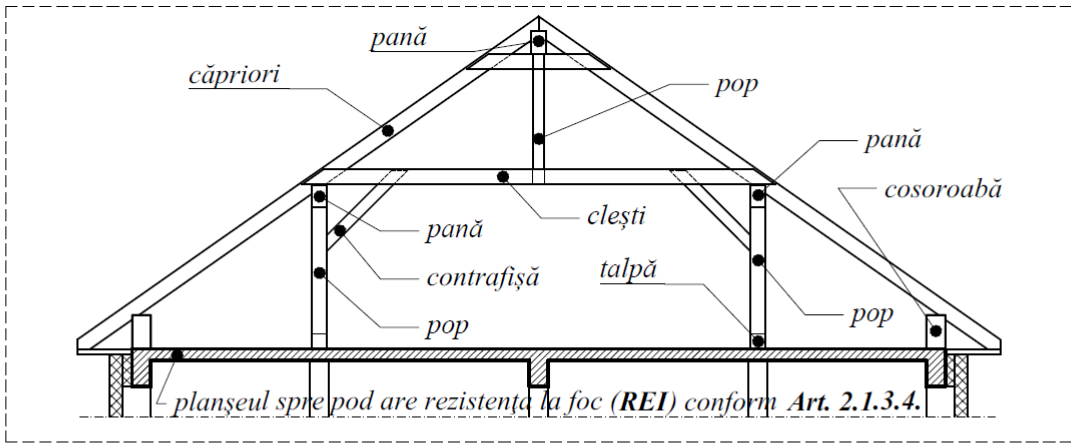
– for the level **I** of fire stability, if the attic floor has fire resistance **REI 90** and it is not suspended from the roof slope and the gaps in the floor to the attic are protected by minimum fire resistant closure elements **EI 90**, normally closed;

– for the level **II** of fire stability, if the attic floor has fire resistance **REI 60** and it is not suspended from the roof slope and the gaps in the floor to the attic are protected by minimum fire resistant closure elements **EI 60**, normally closed;

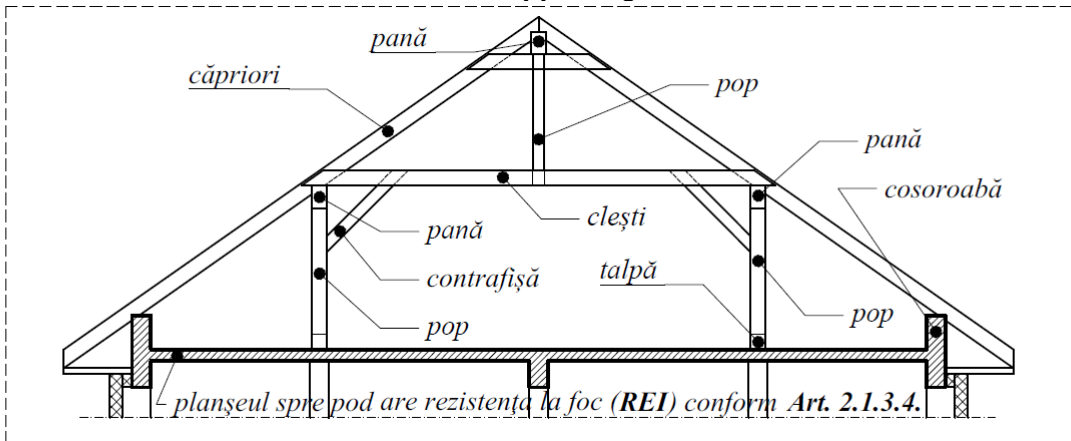
– for the level **II** of fire stability, if the attic floor has fire resistance **REI 45** and it is not suspended from the roof slope and the gaps in the floor to the attic are protected by minimum fire resistant closure elements **EI 45**, normally closed;

– for the level **IV** of fire stability where the components of the structure (pillars, beams, structural walls) have fire resistance of **30** minutes, if the attic floor has fire resistance **REI 30** and it is not suspended from the roof slope and the gaps in the floor to the attic are protected by minimum fire resistant closure elements **EI 30** normally closed;

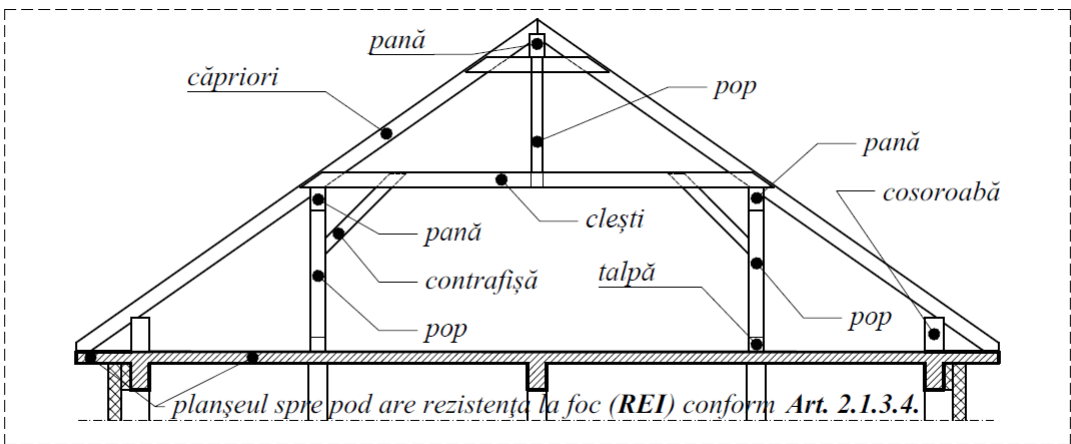
– for the level **V** of fire stability (for the situations provided for in **Note (3) in Table 42**: Conditions for correlation between destination, simultaneous maximum capacity and number of above-ground levels of civil buildings with level **III, IV or V** of fire stability level **V**), if the attic floor has fire resistance **REI 15** and it is not suspended from the roof slope and the gaps in the floor to the attic are protected by minimum fire resistant closure elements **EI 15**, normally closed.



a.1) Not recommended admissible variant, **necessary to be** technically justified for the spread of the fire to the roof framing

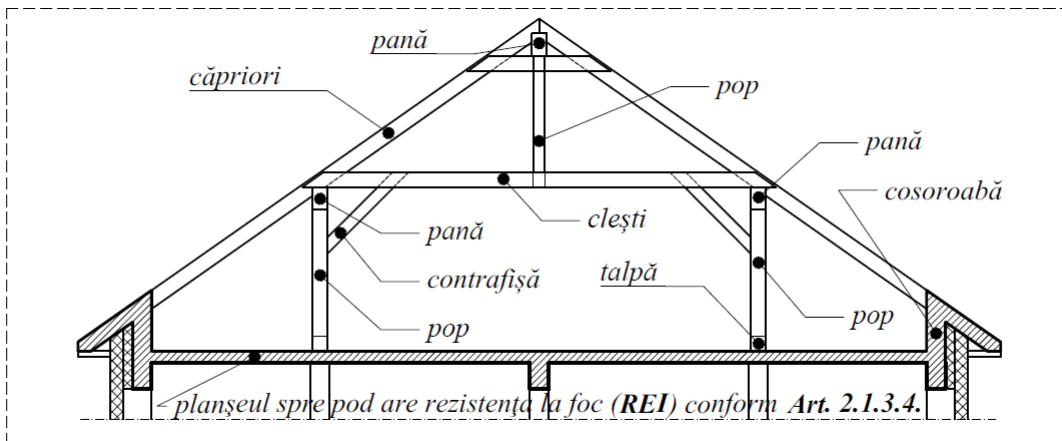


a.2) Admissible variant, **necessary to be** technically justified for the spread of the fire to the roof framing



a.3) Recommended variant

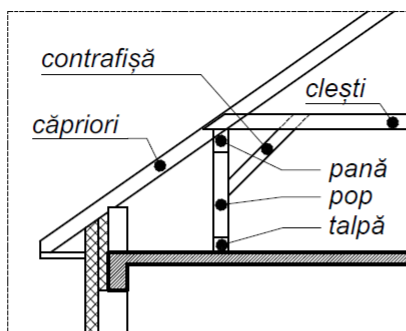




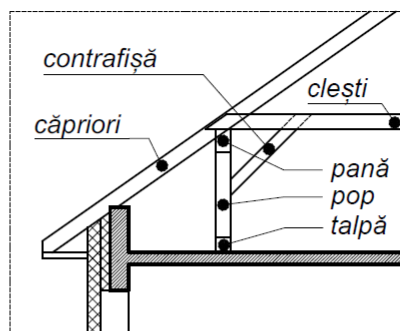
pană	purlin
căpriori	rafters
pop	prop
cosoroabă	wall plate
contrafișă	cantilever
clești	pliers
talpă	foot
planșeul spre pod are rezistența la foc (REI) conform Art. 2.1.3.4.	attic floor has fire resistance (REI) according to Article 2.1.3.4.

**a.4) Recommended variant**

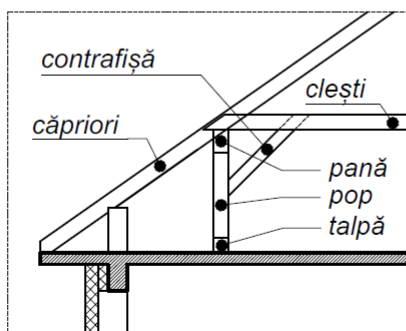
**a) demarcation of the attic roof framing (examples)**



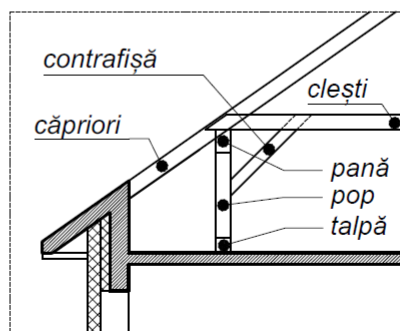
**b.1) Admissible variant, not recommended**



**b.2) Admissible variant**



**b.3) Recommended variant**



**b.4) Recommended variant**

contrafișă	cantilever
căpriori	rafters
clești	pliers
pană	purlin
pop	prop
talpă	foot

## **b) details of demarcation of the attic roof framing (examples)**

### **Figure – 27 Attic roof framing – minimum demarcation through fire resistant floor**

*Note: Provided that the above measures are not met, the slope of the attic roof will meet the requirements set out in **Table 2 point 9** and **Table 3 point 9**, corresponding to the level of fire stability. In high and very high buildings with roofs with attic shall be made entirely of materials **A1** and buildings with crowded rooms shall be foreseen according to **Article 2.1.3.3(2)**.*

*Examples of the closed eaves. Following the same principles of minimum separation through fire resistant floor (according to **Art. 2.1.3.4** depending on whether the construction is classified as a level of fire stability), architectural solutions may also be chosen with a semi-closed or closed eaves.*

**b)** roof coverings of all kinds, with the exception of covering panels specified in **Table 2 point 10** and **Table 3 point 10**, as well as thermal insulations and hydro insulations mounted above a continuous fire-resistant support according to **Table 2 point 3 and point 4** and **Table 3 point 3 and point 4**;

**c)** skylight on the roof of which the summed area (horizontal projection) is less than **25 %** of the area of the space in which they are arranged, but not more than **25 sqm**, regardless of their reaction to fire class;

**d)** atrium skylights (regardless of their area) or skylights larger than **25 %** of the area of the space in which they are located, when made with profile structures of the reaction to fire class **A1** or **A2-s1d0**, except for non-substantial components, insulators and fittings provided with filling panels of single or insulating glazing/glass elements or of products for reaction to fire **A1** or **A2-s1d0**.

**e)** wind bracing of structures, platforms and metal elements required functionally or technologically, which are not taken into account for the strength and stability of the construction in the event of fire;

**f)** the constructional elements of marquises, windfang, verandas, thresholds, stoops and greenhouses;

**g)** non-substantial parts, gaskets, insulators, glazing or glazing elements (made of glass) of external doors and windows, including those inserted into the curtain walls;

**h)** external doors and windows, including those inserted in the curtain walls.

**i)** bulwarks, panels and internal partitions, of a reaction to fire class **A1** or **A2-s1d0** within groupings of open spaces, with the maximum standardised surface area.

**j)** bulkheads and/or panels of combustible materials if the combined height of combustible full panels is not more than or equal to **1.20 m** within groupings of open spaces, with the maximum standardised surface area. Bulwarks and/or panels of combustible materials not exceeding **1.20 m** must met the following conditions:

– minimum reaction to fire class **D-s2d0** or whose finishes meet the minimum fire performance criteria **K<sub>2</sub> 10** (at level **IV** and **V** of fire stability);

– minimum reaction to fire class **C-s2d0** or whose finishes meet the minimum fire performance criteria **K<sub>2</sub> 30** (at level **III** of fire stability);

– minimum reaction to fire class **B-s1d0** or whose finishes meet the minimum fire performance criteria **K<sub>2</sub> 60** (at level **II** of fire stability).

– not admissible (on level **I** of fire stability).

**Article 2.1.3.5. (1)** The class reaction to fire may be reduced to fire resistance of construction elements **A1**, up to the minimum **15** minutes, for walls and floors, pillars, beams, girders, wind bracings and roof framing of buildings roofs and fire compartments of normal heights,

which do not delimit the escape routes of users, which are deemed to meet the requirements for level **II** of fire stability, at:

- a) open overground car parking lots for passenger cars with a maximum clear height **15 m**, with the built-up area (**Ac**) not exceeding **3.000 m<sup>2</sup>** and maximum **3** above-ground levels;
- b) ground-height production and/or storage constructions having a low fire risk, provided that the thermal load density resulting from combustible substances and materials in those spaces does not exceed **420 MJ/m<sup>2</sup>** (combustible materials and substances must not be placed together next to structural elements in such a way as to cause them to be affected) with the built area of no more than **2.000 m<sup>2</sup>**;
- c) ground floor buildings for the bulk storage of cereals with the built-up area (**Ac**) not exceeding **2.000 m<sup>2</sup>**;
- d) overground production and/or storage construction with heat load density (**q**) of maximum **840 MJ/m<sup>2</sup>**, built area (**Ac**) not exceeding **2.000 m<sup>2</sup>** and maximum clear height **15 m**, when fitted with automatic fire-fighting systems.
- e) civil buildings, with maximum three above-ground levels, the area built up (**Ac**) not exceeding **600 m<sup>2</sup>** and the density of the heat load (**q**) not exceeding **420 MJ/m<sup>2</sup>**, which do not house persons who cannot evacuate themselves (defined according to terminology);
- f) open sports constructions with thermal load density (**q**) not exceeding **420 MJ/m<sup>2</sup>**;

(2) In the buildings referred to in **paragraph 1**, floors and walls separating the escape routes in case of fire (corridors, halls, protected openings, staircase), ramps of operating and escape stairways in the event of fire, and the strength structure associated with these building elements, shall satisfy the minimum requirements laid down for structures with level **II** fire stability.

(3) For the production and/or ground floor storage referred to in **paragraph 1**, having a low fire risk, where the thermal load density resulting from combustible substances and materials in those spaces does not exceed **420 MJ/m<sup>2</sup>** no fire performance criteria are set for exhaust separation elements, but the length of escape routes is reduced by **25 %** compared to the value set out in the Rule.

(4) The buildings referred to in **paragraph 1** shall have ensured normal conditions to limit the spread of fires both externally (on façades) and inside the building.

**Article 2.3.1.6 1.** Modular constructions (container type), regardless of the level of fire stability, shall be limited to one level (ground floor).

(2) By way of exception from **paragraph 1**, modular (container type) constructions classified with the level **V** of fire stability with two levels (ground floor and one floor) may be made for site organisation as well as for two level residential buildings (ground floor and one floor).

(3) By way of exception from **paragraph 2**, in the case of constructions for the purpose of organising construction sites falling within the level **V** fire stability, investors/beneficiaries may adopt a level in addition to the provisions of **paragraph 2**, i.e. a ground floor and two floors rise, provided that they are equipped with a fire detection, signalling and alarm system.

**Article 2.3.1.7 1.** Ground floor buildings with storage destination, fully automated, unstaffed in storage, with a clear height higher than **15 m** and heat load greater than **420 MJ/sqm**, equipped with automatic sprinkler fire-extinguishing systems for both ceiling and shelves, or with a water mist extinguishing system or other automatic fire extinguishing systems with total flooding of the entire volume of the construction, may be carried out on the unprotected metallic structure as appropriate to the level **II** of fire stability.

(2) There are no internal hydrants provided for in these constructions and the fire-

extinguishing by the intervention forces shall be carried out only from outside the construction.

(3) The safety distance between these constructions and any neighbouring construction, including those within the property limit, shall be at least equal to the height of the warehouse, to which **15 m** is added.

4. In all cases, the distance between the warehouse and the nearest side of an access and intervention route for firefighter vehicles shall be at least equal to the height of the warehouse to which **10 m** is added.

## SECTION II

### 2.2. Location and compliance of buildings

**Article 2.2.0.1.** The standard conditions for limiting the possibilities for propagation of fires between and within buildings and fire compartments are mandatory and shall be achieved by:

- a) the location at the normal distances or partitioning of the buildings and their corresponding fire compliance;
- b) the constructive composition of the building and installation elements used, according to the provisions laid down in the rules;
- c) ensure constructive protection measures to limit the propagation of fire within buildings and/or fire compartments (fire resistant walls and floors and, where applicable, resistant to volumetric explosion), supplemented by the fire protection installations laid down in the specialised technical regulations.

#### 2.2.1. Location

**Article 2.2.1.1. (1)** Above-ground civil, production and/or storage or mixed construction may be:

- a) located independently at normal distances from neighbourhoods (Figure 28);
- b) bounded by fire resistant bulkheads separating fire compartments (fire bulkheads) and, where applicable, fire resisting floors separating fire compartments (fire floors) (Figure 29);
- c) amalgamated sites, within the maximum built-up area permitted by the Rule (Figure 30).

(2) Distances between the constructions to be merged are not standardised, but by summing up the built-up areas of those buildings (**Ac**) the maximum permissible values for fire compartments shall be complied with, depending on the destination and the least favourable level of fire stability provided (e.g, between level **II** of fire stability and level **IV** of fire stability, level chosen **IV** of fire stability), the highest fire risk and the highest standardised number of levels. Fire compartments resulting from the merger of buildings shall have the level of fire stability determined by the building with the least favourable level, the highest fire risk and the number of standard levels.

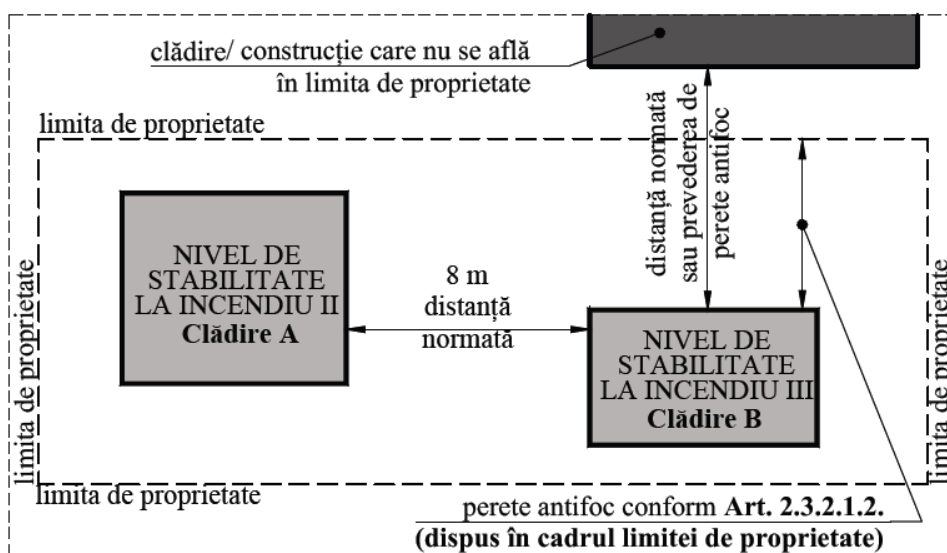
(3) The amalgamation of buildings may only be carried out within the ownership limit, with the exception of housing buildings representing individual units of normal height (max. **S + P + 2 + M**), which may also be amalgamated outside the ownership limit. Thus, residential buildings representing individual units of normal height (max. **S + P + 2 + M**) shall be located without standardizing the distances between them within new civil buildings sections representing individual units for which there are external hydrants networks dimensioned for the worst case scenario, providing for compensatory measures aimed at limiting the propagation of fires from one construction to another, within the maximum permitted limit for a fire compartment (the fire stability level of the construction or fire compartment, is determined by its component or by the amalgamated construction with the most unfavourable to the standard values). The maximum permitted areas of a fire compartment may not be extended under their own responsibility.

(4) Buildings intended for persons who cannot evacuate themselves (defined according to terminology), as well as for objects, equipment or apparatus of particular importance, higher and/or very high civil buildings or with crowded rooms, shall not be amalgamated with other constructions.

(5) In the case of the delimitation of fire resistant bulkheads separating the fire compartments (fire bulkheads) and, where applicable, fire resisting floors separating the fire compartments (fire floors), subdivision from the structures referred to in paragraph 3 may be carried out within the limits of the fire compartments laid down for each separate type or function according to the provisions of the Rule.

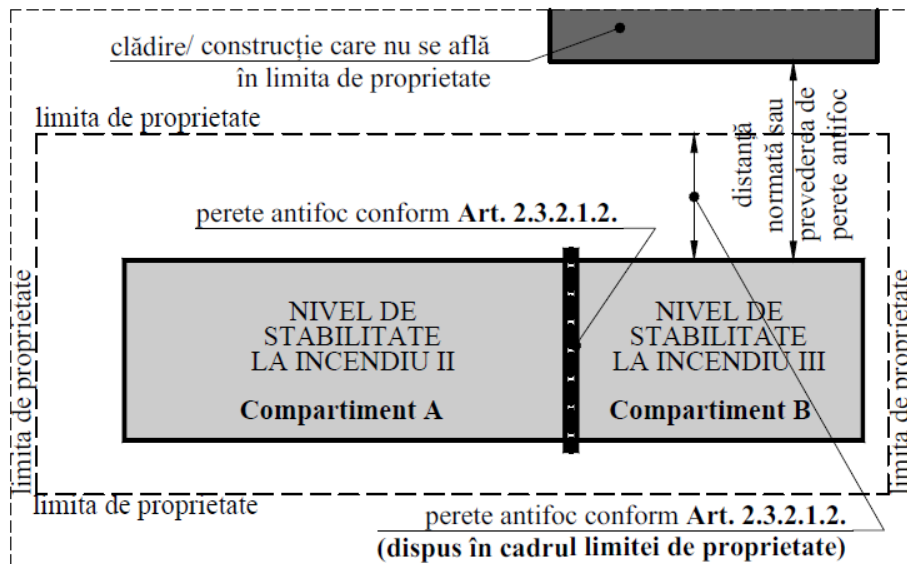
(6) For the buildings referred to in paragraph (3), separation of different types and/or functions from different compartments shall be ensured with vertical and horizontal fire resistance construction elements with fire resistance determined according to the density of the heat load (q) from adjacent spaces, but not less than **REI 180** or **EI-M 180** for walls and minimum **REI 120** for floors and void protection according to the provisions of the Rule, for each fire compartment, access and escape routes for users, as well as suitably sized roadways for the movement and location of vehicles for fire extinguishing and rescue operations, at least on two sides, with the possibility of access to the building on the façade.

(6) The functions embedded (pooled) in a building shall be constituted in a mixed-function building.



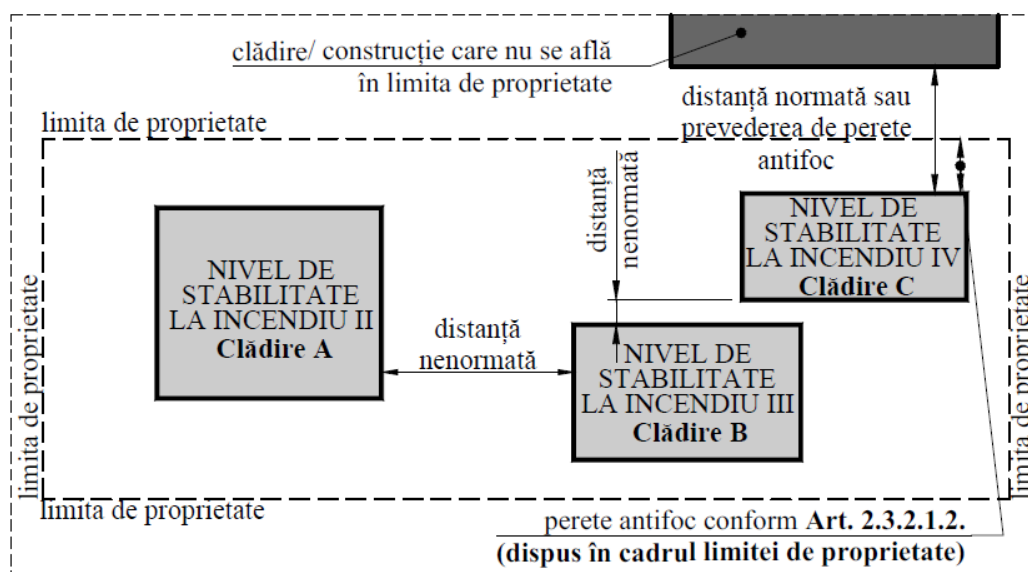
clădire/ construcție care nu se află în limita de proprietate	building/construction not within the limit of ownership
limita de proprietate	property boundary
distanță normată sau prevederea de perete antifoc	standardised distance or provision of fire wall
NIVEL DE STABILITATE LA INCENDIU II Clădire A	FIRE STABILITY LEVEL II <b>Building A</b>
8 m distanță normată	8 m standardised distance
NIVEL DE STABILITATE LA INCENDIU III Clădire B	FIRE STABILITY LEVEL III <b>Building B</b>
perete antifoc conform Art. 2.3.2.1.2. (dispus în cadrul limitei de proprietate)	fire wall according to <b>Article 2.3.2.1.2. (arranged within the ownership limit)</b>

**Figure 28 – – Independent location of constructions (at standardised distances)**



clădire/ construcție care nu se află în limita de proprietate	building/construction not within the limit of ownership
limita de proprietate	property boundary
distanță normată sau prevederea de perete antifoc	standardised distance or provision of fire wall
NIVEL DE STABILITATE LA INCENDIU II <b>Compartment A</b>	FIRE STABILITY LEVEL II <b>Compartment A *</b>
NIVEL DE STABILITATE LA INCENDIU III <b>Compartment B</b>	FIRE STABILITY LEVEL II <b>Compartment B</b>
perete antifoc conform Art. 2.3.2.1.2. (dispus în cadrul limitei de proprietate)	fire wall according to Article 2.3.2.1.2. (arranged within the ownership limit)

**Figure 29 – Partitioned location**



clădire/ construcție care nu se află în limita de proprietate	building/construction not within the limit of ownership
limita de proprietate	property boundary
distanță normată sau prevederea de perete antifoc	standardised distance or provision of fire wall
distanță nenormată	non-standardised distance
NIVEL DE STABILITATE LA INCENDIU II <b>Clădire A</b>	FIRE STABILITY LEVEL II <b>Building A</b>
NIVEL DE STABILITATE LA INCENDIU III <b>Clădire B</b>	FIRE STABILITY LEVEL II <b>Building B</b>
NIVEL DE STABILITATE LA INCENDIU IV <b>Clădire C</b>	FIRE STABILITY LEVEL IV <b>Building C</b>

perete antifoc conform Art. 2.3.2.1.2. (dispus în cadrul limitei de proprietate)	fire wall according to Article 2.3.2.1.2. (arranged within the ownership limit)
--	---

**Figure 30 – Amalgamated location of constructions within the boundaries of the areas of the standardised fire compartments (Ac fire compartment = sum Ac of amalgamated constructions)**

**Article 2.2.1.2. (1)** Standalone buildings and/or buildings consisting of more than one fire compartment shall be located in relation to the other buildings or fire compartments at the minimum safety distances set out in Table 4 or shall be demarcated by fire resistant bulkheads separating fire compartments (fire bulkheads) and, where applicable, fire resisting floors separating fire compartments (fire floors).

**(2)** Buildings amalgamated into a fire compartment shall be positioned in relation to the other structures or fire compartments at the minimum safety distances set out in Table 4, depending on the fire stability level established according to **Article 2.2.1.1(2)** or demarcated by fire resistant bulkheads separating fire compartments (fire bulkheads) and, where applicable, fire resisting floors separating fire compartments (fire floors).

**Table 4: Minimum safety distances between structures or above-ground fire compartments (civil, production and/or storage)**

Fire stability level of the construction	Minimum safety distances (m), from neighbouring constructions with the fire stability level:		
	I - II	III	IV - V
I - II	6	8	10
III	8	10	12
IV - V	10	12	15

*Notes: a) For buildings with a very high risk of fire, the safety distances from the surroundings shall be increased according to the provisions of the Rule, but shall not be less than 12 m. Where the construction works are also at risk of volumetric explosion, the distances shall also comply with the provisions of the specific regulations, but shall not be less than 15 m.*

*b) The safety distance between buildings can be reduced by no more than 25 % if at least one of the buildings is fully equipped with sprinkler fire-extinguishing systems according to the provisions of the Standard P118: 2, having regard to spaces exempted from equipment and those protected by other compatible automatic extinguishing systems.*

*c) When constructions are also at risk of volumetric explosion, distances shall also comply with the provisions of the specific technical regulations.*

## 2.2.2. Compliance

**Article 2.2.2.1. (1)** By conformation of buildings and fire compartments, the standard conditions for correlation between the fire stability level provided, the area built up (Ac), destination, number of levels, maximum simultaneous user capacity and building type, shall be complied with, limiting the possibilities for the spread of fire and smoke within them, as well as to neighbourhoods and neighbourhoods.

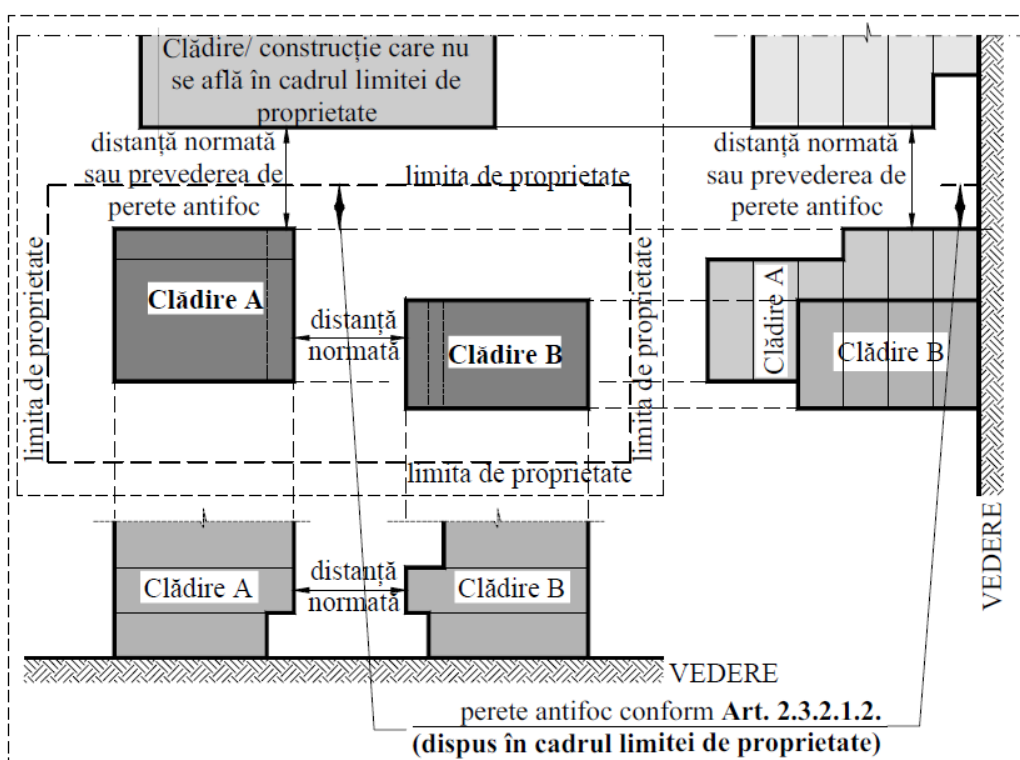
**(2)** Activities/spaces with high risk, very high fire risks and those with risks of volumetric explosion (when permitted) shall be arranged as far as possible in separate areas of the construction (those with risks/danger of volumetric explosion is recommended to be placed at the last above-ground level of the construction), shall be carried out according to the provisions on the common and specific performance of the construction works and only with the provision of appropriate protective measures.

**Article 2.2.2.2.** Depending on the level of fire stability provided, civil, production and/or storage structures and above ground fire compartments shall comply with the provisions of the Rule.

**Article 2.2.2.3.** In order to limit the spread of fire, civil, production and/or storage structures shall be separated within the normal areas of the fire compartments concerned.

**Article 2.2.2.4. (1)** The different activities in the construction and fire compartments are separated by walls (**EI/REI**) and floors (**REI**), with fire resistance appropriate to fire risks and heat load density (**q**) in adjacent rooms, according to the provisions of the Rule and those set out in Table 5 and Table 6. Fire resistant walls and floors intended to separate fire compartments shall meet the requirements laid down in the Rule.

**(2)** Where they do not meet the minimum safety distances between independent constructions which are not merged and whose fire control must be made towards facades with curtain walls, by way of exception to the provisions of **Art. 2.3.2.1.2 point (d)**, vertical components separating fire compartments made from curtain walls with minimum fire resistances **EI120 (o ↔ i)** shall be permitted within the property limit, provided that at least one of the two independent constructions is fully equipped with sprinkler fire-extinguishing systems, according to the provisions of the Standard **P118:2** (Figure 31). Spaces with a thermal load density higher than **630 MJ/m<sup>2</sup>** or spaces of very high fire risk and volumetric explosion towards the fire wall consisting of a curtain wall **EI120 (o ↔ i)** shall not be allowed.



Clădire/ construcție care nu se află în limita de proprietate	Building/construction not within the limit of ownership
limita de proprietate	property boundary
distanță normată sau prevederea de perete antifoc	standardised distance or provision of fire wall
distanță standardised	non-standardised distance
<b>Clădire A</b>	<b>Building A</b>
<b>Clădire B</b>	<b>Building B</b>
VEDERE	VIEW
perete antifoc conform Art. 2.3.2.1.2. (dispus în cadrul limitei de proprietate)	fire wall according to Article 2.3.2.1.2. (arranged within the ownership limit)

**Figure 31 – Minimum safety distances between independent constructions**



## SECTION III

### 2.3. LIMITING THE SPREAD OF FIRES

#### 2.3.1. General provisions

**Article 2.3.1.1. (1)** The building elements, walls and floors used to limit the spread of fires and their effects and explosions are of the type:

- fire resistant (**REI** or **EI**);
- explosion resistant (**REI**);
- thermal radiation (**W**);
- fire tight (**E**)
- fire resistant with mechanical action (**REI** or **EI-M**)

**(2)** It is mandatory to ensure the continuation of the minimum conditions for walls and floors in front of compaction joints with sealing solutions.

**(3)** The protection of functional voids in these building elements shall be achieved, where appropriate, with doors, shutters, curtains, buffers ventilated in excess pressure or open tambours, constructed and sized according to the provisions of the Rule.

**Article 2.3.1.2.** Standardised fire resistances of walls (**EI/REI**) and floors (**REI**) partitioning rooms with different functions (according to the maximum areas and conditions laid down in the Rule), determined according to the density of the heat load (**q**) in adjacent spaces and/or depending on the highest density of the heat load (**q**) of the spaces they separate are specified in Table 5, unless other conditions are laid down by the Rule.

**Table 5: Standardised fire resistances of walls (EI/REI) and floors (REI) corresponding to heat load densities (q) in adjacent spaces and/or heat load densities (q) highest in the spaces they split**

Density of heat load (q) in rooms (MJ/m <sup>2</sup> )	Minimum fire resistance (EI/REI) of walls (minutes)		Minimum fire resistance (REI) of floors (minutes)			
			for civil buildings		in production/storage constructions	
	not equipped with automatic fire-extinguishing systems	equipped with automatic fire-fighting systems	not equipped with automatic fire-extinguishing systems	equipped with automatic fire-fighting systems	not equipped with automatic fire-extinguishing systems	equipped with automatic fire-fighting systems
$q \leq 105 \text{ MJ/m}^2$	No requirement		No requirement		No requirement	
$105 \text{ MJ/m}^2 < q \leq 210 \text{ MJ/m}^2$	30	15	30	15	30	15
$210 \text{ MJ/m}^2 < q \leq 210 \text{ MJ/m}^2$	60	30	45	30	60	30
$420 \text{ MJ/m}^2 < q \leq 210 \text{ MJ/m}^2$	90	60	60	45	90	60
$630 \text{ MJ/m}^2 < q \leq 210 \text{ MJ/m}^2$	120	90	90	60	120	90
$840 \text{ MJ/m}^2 < q \leq 1680 \text{ MJ/m}^2$	180	120	120	90	180	120
$q > 1680 \text{ MJ/m}^2$	240	180	180	120	180	120

**Article 2.3.1.3.** The building elements used to limit the spread of fire and volumetric explosions and their effects shall be fire-resistant (walls) **EI/REI**, floors **REI**) and, where appropriate, explosion resistant.

**Article 2.3.1.4.** Functional and escape pass-through voids in construction elements designed to limit the propagation of fire and/or explosions shall be protected by closing elements corresponding to the provisions of the Rule.

## 2.3.2. Fire protection elements for the separation of fire compartments and the protection of functional pass-through voids

### 2.3.2.1. Fire bulkheads for the separation of fire compartments

**Article 2.3.2.1.1. (1)** (Fire) walls separating fire compartments shall be made from materials **A1** or **A2-s1d0**, so placed, constructed and sized as to resist the effects of fires in the fire compartments they separate.

**(2)** In constructions with reinforced concrete or metallic structures, fire resistant wall separating fire compartments (fire walls) may be incorporated directly into these structures, which shall be so constructed or protected as to have fire resistance at least equal to that required for those fire walls.

**(3)** Fire walls which separate, on certain portions of them, explosion-hazardous spaces shall meet the conditions prescribed for explosion-resistant walls in these portions.

**Article 2.3.2.1.2.** Fire walls separating fire compartments shall have fire resistance:

- a) minimum value of the strength structure of the building (in line with Table 2 and Table 3) not less than 1 hour (**EI-M 60/REI 60**), according to Table 6, in conjunction with the density of the building's thermal load (according to the provisions of the same table), for buildings with ground floor rise. The provisions do not apply to buildings with persons who cannot evacuate themselves (defined according to terminology) and buildings with crowded rooms.

**Table 6: Standardised fire resistances of bulkheads separating fire compartments (EI-M/REI) for buildings with ground height regime, excluding buildings with persons who cannot evacuate themselves and buildings with crowded rooms, corresponding to the densities of heat loads (q) in adjacent spaces and/or heat load densities (q) in the spaces they separate**

Density of heat load (q) in rooms (MJ/m <sup>2</sup> )	Minimum fire resistance (EI/REI) of walls (minutes)
$q \leq 420 \text{ MJ/m}^2$	<b>EI-M 60/REI 60</b>
$420 \text{ MJ/m}^2 < q \leq 630 \text{ MJ/m}^2$	<b>EI-M 90/REI 90</b>
$630 \text{ MJ/m}^2 < q \leq 840 \text{ MJ/m}^2$	<b>EI-M 120/REI 120</b>
$840 \text{ MJ/m}^2 < q \leq 1\ 680 \text{ MJ/m}^2$	<b>EI-M 180/REI 180</b>
$q > 1\ 680 \text{ MJ/m}^2$ (and/or there is a volumetric explosion hazard)	<b>EI-M 240/REI 240</b>

Note: For ground floor constructions fully equipped with automatic fire-fighting systems (according to the provisions of Rule **P118: 2**, except as provided for spaces equipped with other automatic extinguishing systems) and thermal load density values higher than **840 MJ/m<sup>2</sup>**, the values in Table 5 may be used.

- b) minimum **EI-M 180/REI 180** for buildings intended for persons who cannot evacuate themselves (defined according to terminology), for buildings with a high fire risk and for objects, equipment or apparatus of particular importance, for above-ground and/or very high civil buildings or buildings with crowded rooms;
- c) minimum **EI-M 240/REI 240** for constructions with very high fire risk (when density of heat load (q) is greater than **1 680 MJ/m<sup>2</sup>** and/or there is a volumetric explosion hazard);
- d) minimum **EI-M 120/REI 120** for buildings of a height other than the ground floor, with the exception of buildings as defined in **(b)** and **(c)**;

**Article 2.3.2.1.3.** Walls separating fire compartments must section the construction throughout its height and may be located:

- a) in buildings of equal height (Figure 35 and Figure 36);
- b) in buildings of different heights:
- i. in the building with a higher height (Figure 33);

ii. in the building with the lower height (Figure 34).

**Article 2.3.2.1.4. (1)** In buildings of the same height, a strip with minimum fire resistance **REI 60** shall be provided in the roof.

**(2)** The strip provided for in **paragraph 1** may be located entirely on either side of the fire compartment division wall or interleaved on either side of the fire wall.

**Article 2.3.2.1.5. 1.** In the case of buildings of different heights, fire resistant bulkheads separating fire compartments (fire bulkheads) may be fitted at the highest construction, throughout its height, with a minimum of enclosure of the covering plane **60 cm** (Figure 32) or at least **8 m** vertical relative to the lower construction (Figure 33).

**(2)** In the case of buildings of different heights, fire resistant bulkheads separating fire compartments (fire bulkheads) may be foreseen in the lower construction if it is so constructed that the fire cannot protrude by passing the bulkhead over the distance of **6 m** from higher construction (Figure 34). The smaller construction shall meet the following conditions:

**a)** the roof is free of holes, with minimum fire resistance **REI 60** and covering having reaction to fire class **A1** or **A2-s1d0** or protected by materials classified as reaction to fire **A1** or **A2-s1d0** (poorly reinforced cement screw, protective mortar, tiles, gravel, slag, etc.) or **B<sub>ROOF</sub>(T4)**;

**b)** rooms with heat load density greater than **840 MJ/m<sup>2</sup>**, adjacent to the bulkhead in that portion, be provided with automatic fire extinguishing systems.

**Article 2.3.2.1.6. (1)** Fire resistant bulkheads separating fire compartments (fire bulkheads) shall protrude by a minimum (*Figure 36 variant a) and b) and Figure 37*):

– **60 cm** (measured vertically), from any such combustible element of roofs and skylights with less than four **4 m** distance from the fire resistant wall, including sheet rest roofs and thermal insulation which are not the reaction to fire class **A1** or **A2-s1d0**;

– **60 cm** (measured vertically), from the outer plane of roofs not made exclusively of substantial components with the reaction to fire class **A1** or **A2-s1d0** it intersects;

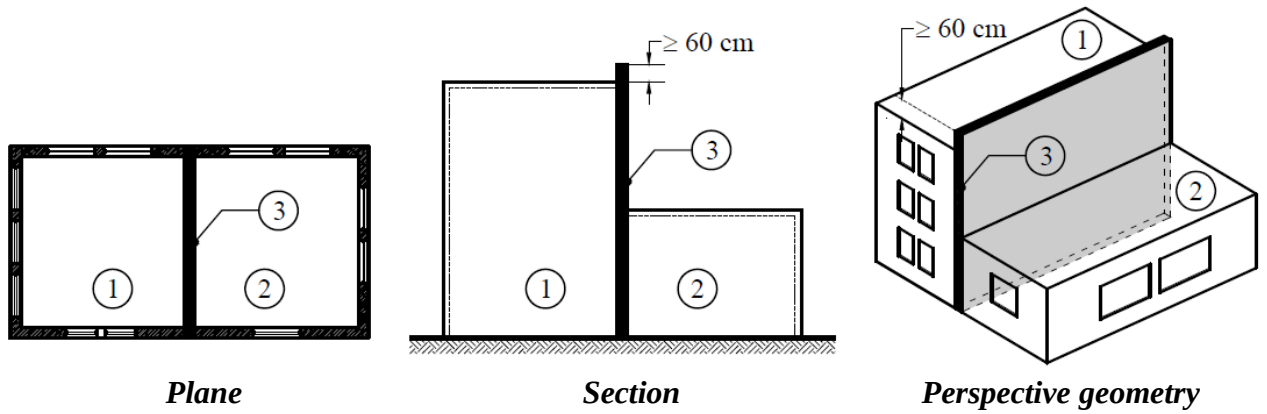
– **60 cm** (measured vertically), from the external plane of skylights less than four **4 m** fire resistant bulkhead separation distance of fire compartments;

– **30 cm** (measured horizontally) from external walls and eaves not made exclusively of substantial components which are not the reaction to fire class **A1** or **A2-s1d0**;

**(2)** Exceeding the planes of roofs, eaves and walls referred to in **paragraph 1** can be replaced by roof strips **REI60** (fully located on either side of the fire or enclosed bulkhead on either side of the fire bulkhead), respectively eaves or wall with fire resistance corresponding to the fire stability level of the building, with a width of at least **6.00 m** and reaction to fire class **A1** or **A2-s1d0**.

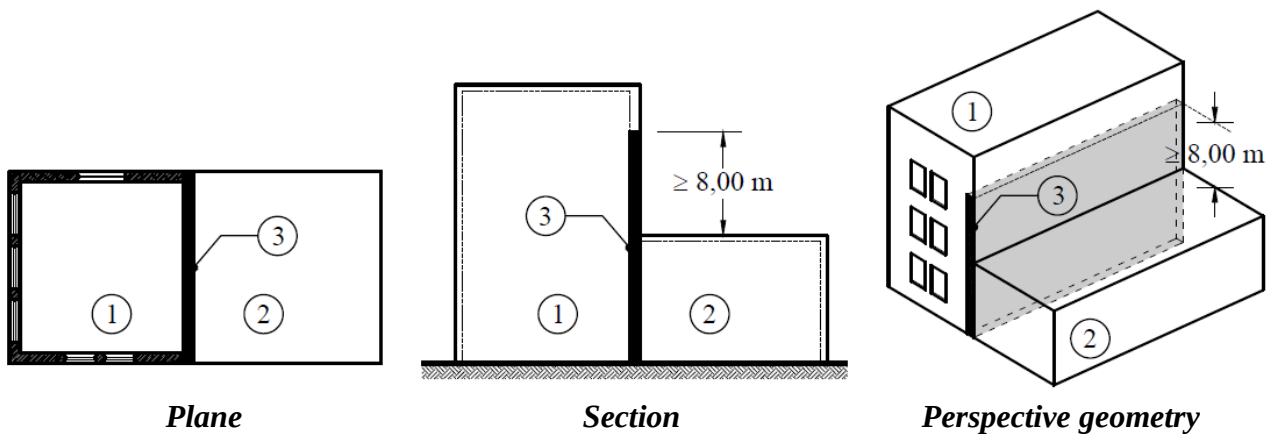
**(3)** Fire resistant bulkheads separating fire compartments (fire bulkheads) need not exceed the plane of roofs with covering and thermal insulation made of combustible materials mounted on the reinforced concrete plate (**REI**) and roofs made entirely of substantial components reaction to fire class **A1** or **A2-s1d0**.

**Article 2.3.2.1.7.** On roofs, terrace or roof framing, on at least **4.00 m** on either side of the fire resistant wall delineating the fire compartments, the skylights shall be fixed, with minimum fire resistance of **30 minutes** depending on their inclination angle.



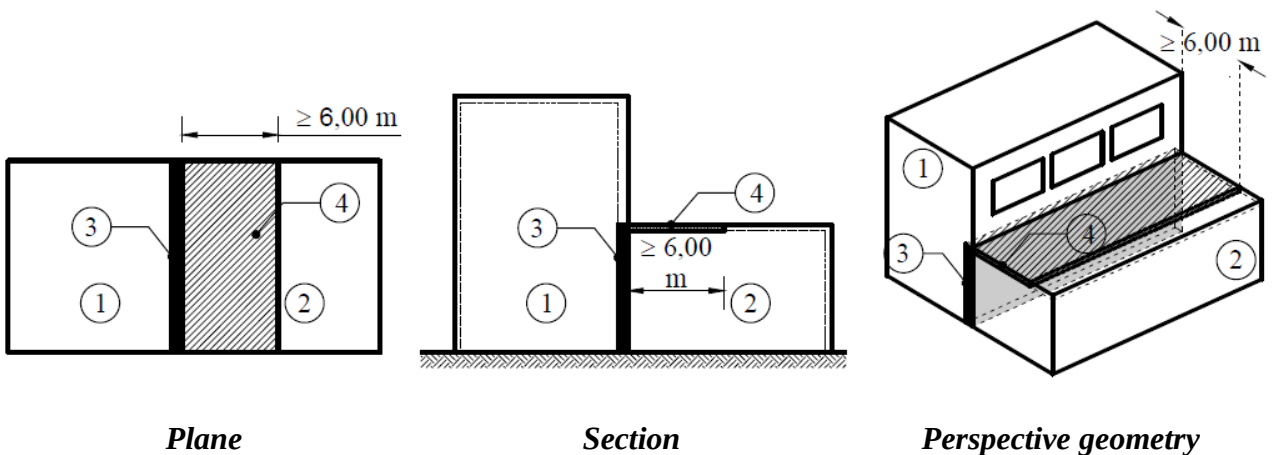
**Figure 32 – Fire resistant bulkhead separating the fire compartments (fire bulkhead A1, A2s1d0 according to Article 2.3.2.1.2) dividing the construction over its full height**

Legend Figure 33: 1 – fire compartment 1; 2 – fire compartment 2; 3 – fire wall compliant to Article 2.3.2.1.2.



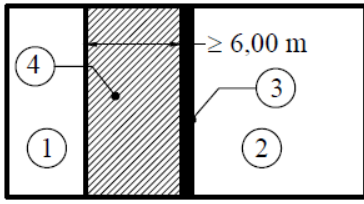
**Figure 33 – Separation of fire compartments in buildings of different heights – separation at the higher building**

Legend Figure 34: 1 – fire compartment 1; 2 – fire compartment 2; 3 – fire wall compliant to Article 2.3.2.1.2.

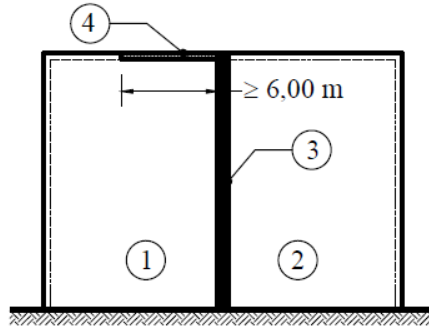


**Figure 34 - Separation of fire compartments in buildings of different heights – separation in lower height building**

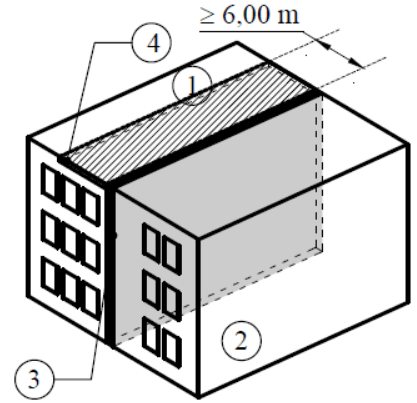
Legend Figure 35: 1 – fire compartment 1; 2 – fire compartment 2; 3 – fire wall according to Article 2.3.2.1.2; 4 – fire resistant (resistant strip) floor min. REI60



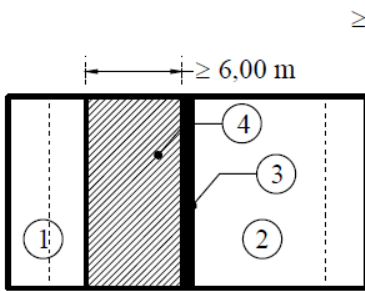
Plane



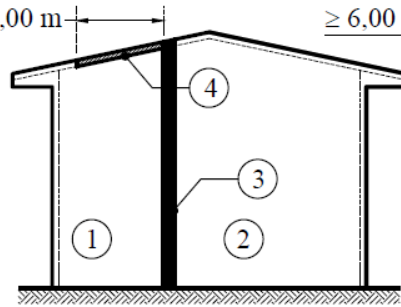
Section



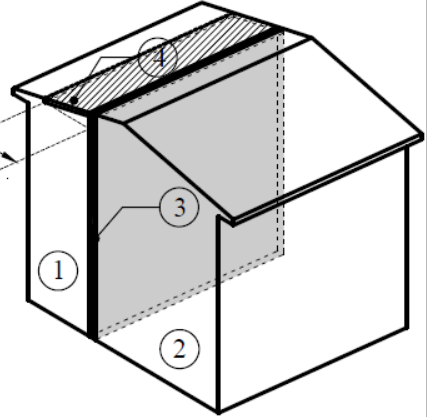
Perspective geometry



Plane

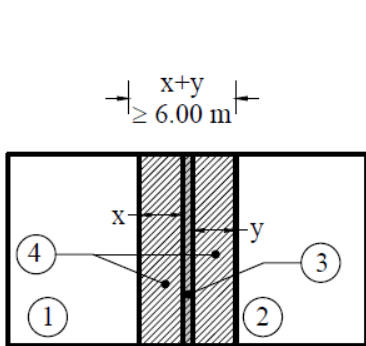


Section

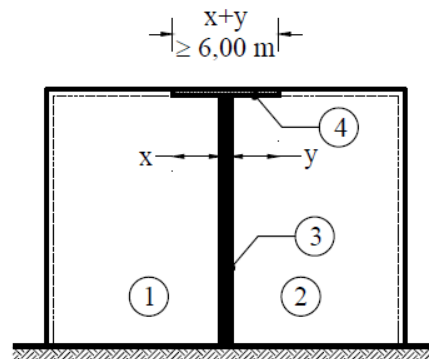


Perspective geometry

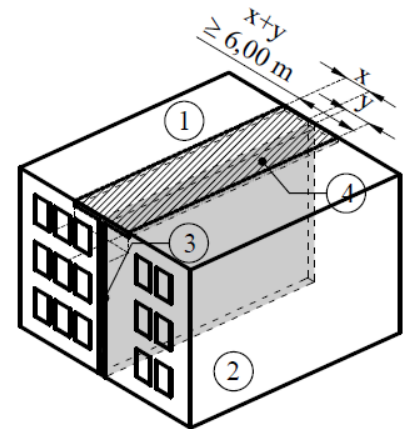
**Variant a) Separate fire compartments with heights equal to the REI60 strip located entirely on either side of the fire wall**



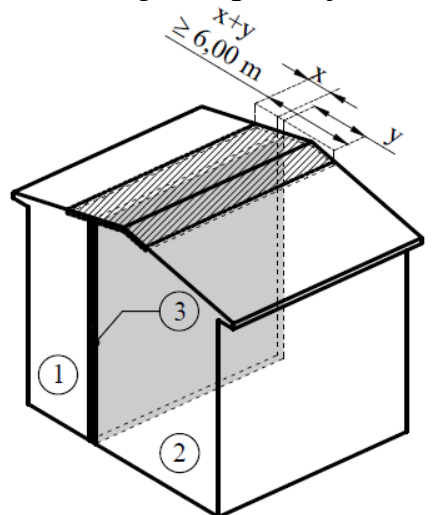
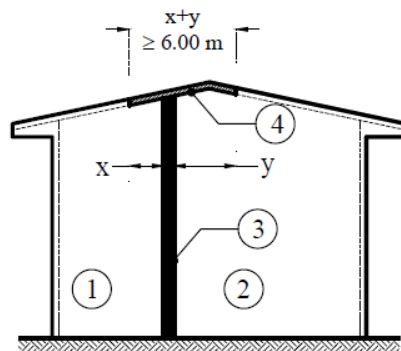
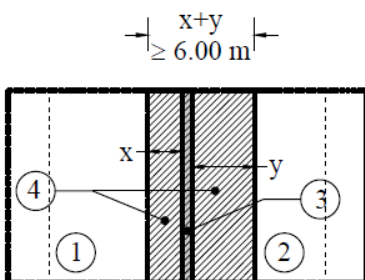
Plane



Section



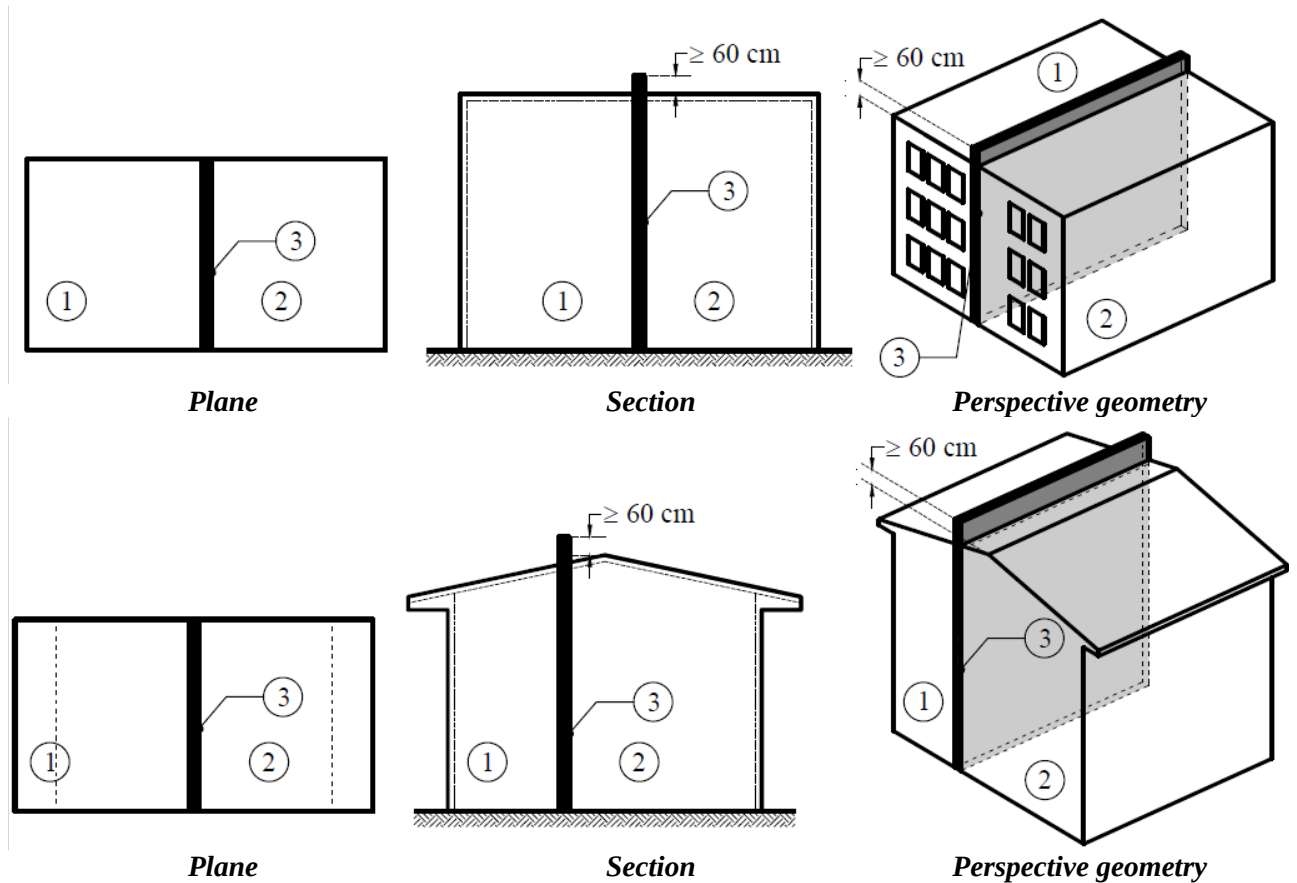
Perspective geometry



**Plane** **Section** **Perspective geometry**  
**Variant b) Separate fire compartments with heights equal to the interleaved REI60 strip on either side of the fire wall**

**Figure 35 - Separation of fire compartments with heights equal to REI60 strip**

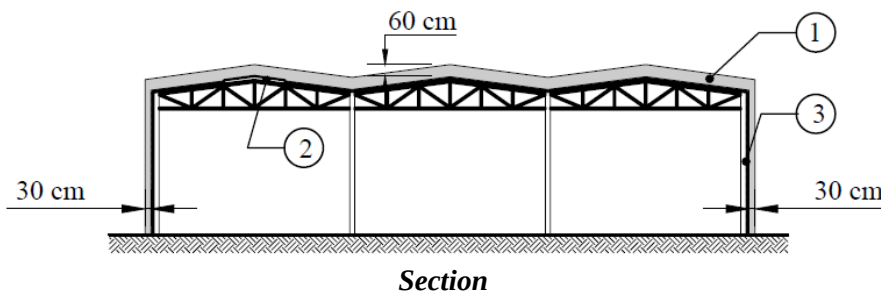
**Legend Figure 36:** 1 – fire compartment 1; 2 – fire compartment 2; 3 – fire wall according to **Article 2.3.2.1.2**; 4 – fire resistant strip min. **REI60**

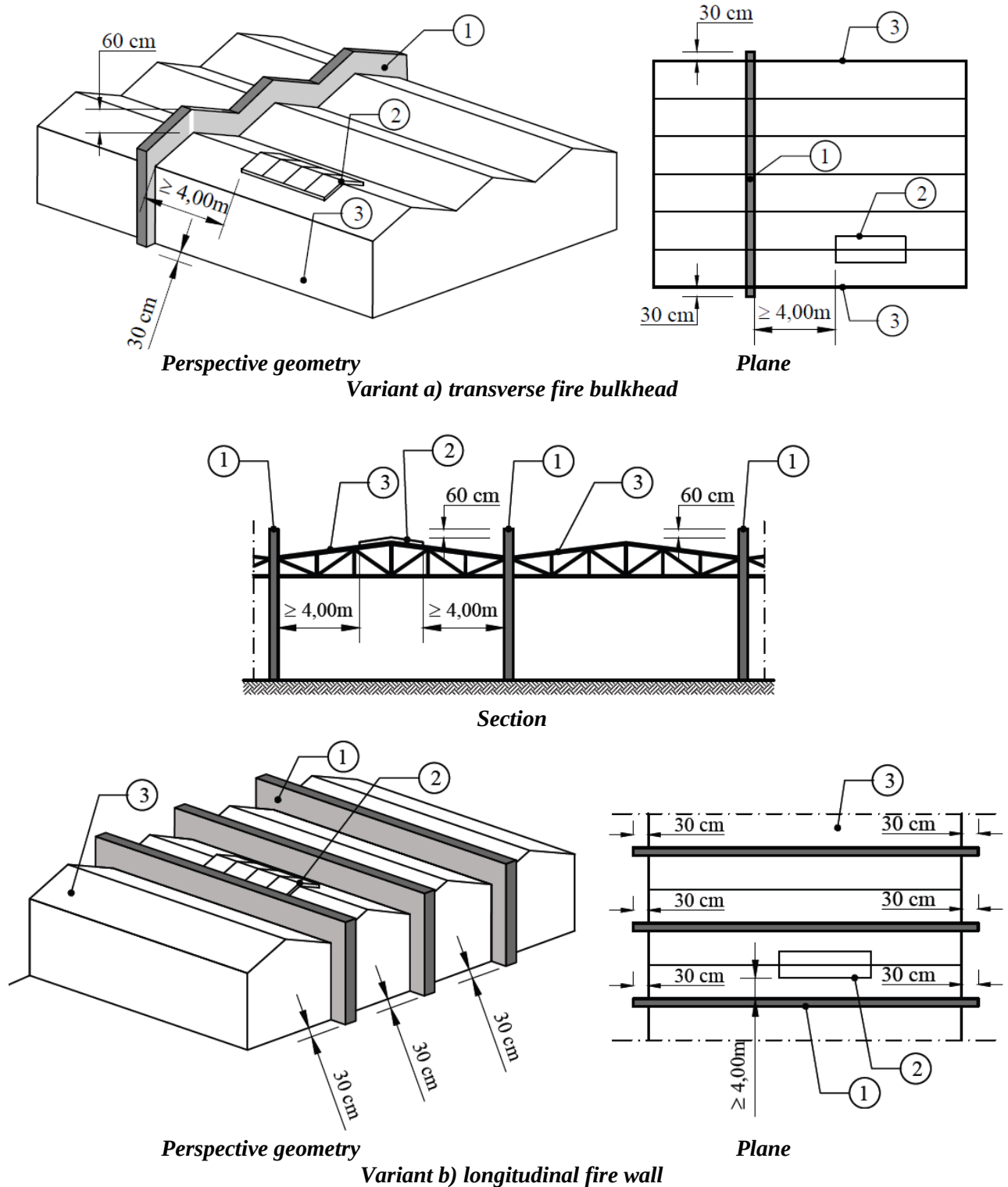


Separation of fire compartments of equal heights by exceeding with at least 60 cm (measured vertically), from any such roofing combustible element

**Figure 36 - Separation of fire compartments of equal heights by exceeding with at least 60 cm (of the fire wall)**

**Legend Figure 37:** 1 – fire compartment 1; 2 – fire compartment 2; 3 – fire wall compliant to **Article 2.3.2.1.2**.





**Figure 37 – Exceedance of external planes of combustible roofs and walls**

**Legend Figure 38:** 1 – fire resistant bulkhead separating the fire compartments according to **Article 2.3.2.1.2**; 2 – skylight fitted at a distance of min. **4 m** (not made of products of a reaction to fire class **A1** or **A2-s1d0**); 3 – combustible roof (not made of a products of reaction to fire class **A1** or **A2-s1d0**)

**Article 2.3.2.1.8.** Fire resistant bulkheads separating fire compartments (fire bulkheads) shall be placed in such a way as to avoid the possibility of propagation of fire from one fire compartment to another through unprotected gaps in external walls, placed at the inner corners of buildings or combustible constructions located in the vicinity.

**Article 2.3.2.1.9. (1)** Where bulkheads are located at the inner corners of civil buildings in

the shape of **L**, **T** or **U** at an angle  $\alpha$ ,  $\alpha < 90^\circ$  (Figure 38), gaps in adjacent external walls shall be arranged in such a way that the distance between them is at least 4 m, depending on the fire stability level of the compartments they separate (calculate radially as shown in Figure 38). Is mandatory that over lengths generated according to the fire stability level of the compartments it separates, within a distance less than or equal to 4 m calculated equidistant between them, the external walls on all sides of this portion and the functional voids thereof shall be protected by fire resistant elements as shown in Table 7 and Table 8. In all cases where angle  $\alpha < 90^\circ$  the fire resistance of the external walls on all sides of this portion is provided according to Table 7 and Table 8 for a minimum length of 4 m on each part (from inflection).

**Table 7: Fire resistance of external walls and fire-resistant closing element of functional voids provided in external walls located at the inner corners of civil buildings (with the exception of buildings with persons who cannot evacuate themselves and buildings with crowded rooms) in the shape of L, T or U at an angle  $\alpha$ ,  $\alpha < 90^\circ$ , where the gaps in adjacent external walls are arranged in such a way that their distance is less than 4 m**

<i>In the case of fire bulkheads separating fire compartments</i>	<i>Thermal load density (q) in perimeter rooms (over a distance of less than 4 m)/construction (MJ/m<sup>2</sup>)</i>	<i>Minimum fire resistance (EI/REI) of external walls – over a minimum distance of 4 m</i>	<i>Fire resistant closing element<sup>2)</sup></i>
<b>1</b>	<b>2</b>	<b>3</b>	<b>4</b>
<i>For buildings with a height regime ground floor<sup>1)</sup></i>	<i>for <math>q \leq 420 \text{ MJ/m}^2</math></i>	<i>EI 45/REI 45 (EI 30/REI 30 *)</i>	<i>EI 30 (EI 15*)</i>
	<i><math>420 \text{ MJ/m}^2 &lt; q \leq 630 \text{ MJ/m}^2</math></i>	<i>EI 60/REI 60 (EI 45/REI 45 *)</i>	<i>EI 45 (EI 30*)</i>
	<i><math>630 \text{ MJ/m}^2 &lt; q \leq 840 \text{ MJ/m}^2</math></i>	<i>EI 90/REI 90 (EI 60/REI 60 *)</i>	<i>EI 60 (EI 45*)</i>
	<i><math>840 \text{ MJ/m}^2 &lt; q \leq 1\ 680 \text{ MJ/m}^2</math></i>	<i>EI 120/REI 120 (EI 90/REI 90 *)</i>	<i>EI 90 (EI 60*)</i>
	<i><math>q &gt; 1\ 680 \text{ MJ/m}^2</math> and/or there is a volumetric explosion hazard)</i>	<i>EI 180/REI 180 (EI 120/REI 120 *)</i>	<i>EI 120 (EI 90*)</i>

**Notes:**

<sup>1)</sup> - Refers to ‘Fire walls for buildings with ground height regime’ as defined in **Article 2.3.2.1.2 point (a)**.

<sup>2)</sup> - Refers to ‘Fire resistant closing elements (doors, windows) fitted with self-closing’C’or fixed, if the distance between openings is less than 4 m’.

**Notes:**

For closed buildings, the specification **EW** or **EI** applies for fire resistant parts (doors, windows), depending on the proximity between openings (if less than 1 m mandatory for fire performance **EI**). For open buildings, the specification **E** may apply in fire resistant elements (doors, windows).

For buildings within the stability level **I**, **II** and **III**, reaction to fire class of **walls** (from outside) defined in the table is **A1** or **A2-s1,d0**. For buildings within the stability level **I**, **II** and **III**, reaction to fire class of **fire resistant closing elements** defined in the table is **A1** or **A2-s1, d0**, except for non-substantial parts, gaskets, insulators, glazing (glass) elements (made of glass), of doors and windows (exterior), including those inserted in the curtain walls.

Fire resistance of all elements defined in columns 3 and 4 of the table is in minutes.

\* The values in brackets shall apply in cases where the rooms are equipped with automatic fire-fighting systems (according to the provisions of Rule **P118: 2**, except as provided for spaces equipped with other automatic extinguishing systems).

**Table 8: Fire resistance of external walls and fire resistant closing elements of functional voids provided in external walls located at the inner corners of civil buildings (excluding buildings referred to in Article 2.3.2.1.2 (a)) in the form of L, T or U at an angle  $\alpha$ ,  $\alpha < 90^\circ$ , where the gaps in adjacent external walls are arranged in such a way that their distance is less than 4 m**



Fire stability level	$\alpha < 90^\circ$					
	In case of fire walls, minimum class EI-M 240/REI 240 <sup>1)</sup>		In the case of fire walls, minimum class EI-M 180/REI 180 <sup>2)</sup>		In the case of fire walls, minimum class EI-M 120/REI 120 <sup>3)</sup>	
	Fire resistance (EI/REI) of external walls <sup>4)</sup>	Fire resistant closing elements <sup>5)</sup>	Fire resistance (EI/REI) of external walls <sup>4)</sup>	Fire resistant closing elements <sup>5)</sup>	Fire resistance (EI/REI) of walls from outside <sup>4)</sup>	Fire resistant closing elements <sup>5)</sup>
1	2	3	4	5	6	7
V	EI/REI 30	EI 15	EI/REI 15	EI 15	EI/REI 15	EI 15
IV	EI/REI 180 (EI/REI 120*)	EI30	EI/REI 30	EI 15	EI/REI 30	EI 15
III	EI/REI 180 (EI/REI 120*)	EI 45 (EI 30*)	EI/REI 180 (EI/REI 120*)	EI 30 (EI 15*)	EI/REI 180 (EI/REI 120*)	EI30 (EI 15*)
II	EI/REI 180 (EI/REI 120*)	EI 60 (EI 45*)	EI/REI 180 (EI/REI 120*)	EI 45 (EI 30*)	EI/REI 180 (EI/REI 120*)	EI 45 (EI 30*)
I h ≤ 28m	EI/REI 180 (EI/REI 120*)	EI 60 (EI 45*)	EI/REI 180 (EI/REI 120*)	EI 45 (EI 30*)	EI/REI 180 (EI/REI 120*)	EI 45 (EI 30*)
I 28m < h < 45m	EI/REI 180 (EI/REI 120*)	EI 90 (EI 60*)	EI/REI 180 (EI/REI 120*)	EI 60 (EI 45*)	-	-
I 45 m ≤ h < 75m	EI/REI 180 (EI/REI 120*)	EI 120 (EI 90*)	EI/REI 180 (EI/REI 120*)	EI 90 (EI 60*)	-	-
I 75m ≤ h < 125m	-	-	EI/REI 180 (EI/REI 120*)	EI 120 (EI 90*)	-	-
I h ≥ 125m	-	-	-	-	-	-

**Notes:**

<sup>1)</sup> - Refers to 'Fire walls at least in class EI-M 240/REI 240 for constructions with very high fire risk (when the heat load density (q) is greater than 1 680 MJ/m<sup>2</sup> and/or there is a volumetric explosion hazard)' as defined in Article 2.3.2.1.2 (b).

<sup>2)</sup> - Refers to 'Fire walls at least in class EI-M 180/REI 180 for buildings intended for persons who cannot evacuate themselves (defined according to terminology), for buildings with a high fire risk and for objects, equipment or apparatus of particular importance, for above-ground and/or very high civil buildings or buildings with crowded rooms' as defined in Article 2.3.2.1.2 (c).

<sup>3)</sup> - Refers to 'Fire walls at least in class EI-M 120/REI 120' as defined in Article 2.3.2.1.2 (d).

<sup>4)</sup> - Refers to 'Resistance to fire' (EI/REI) of external walls, for a minimum distance of 4 m'

<sup>5)</sup> - Refers to 'Fire resistant closing elements (doors, windows) fitted with self-closing' C' or fixed, if the distance between openings is less than 4 m'.

'h' = elevation of the last accessible/usable floor of the construction from the reference level

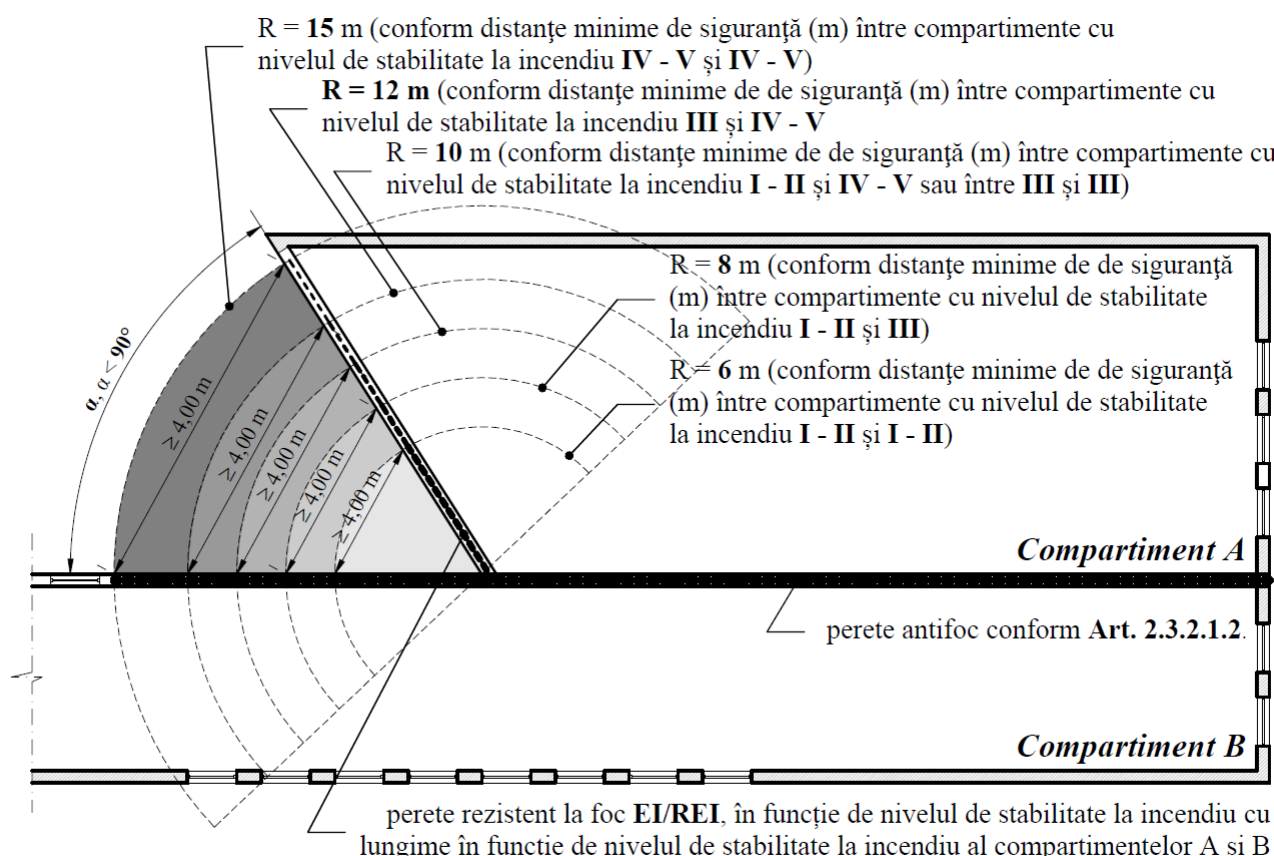
**Notes:**

For buildings within the stability level I, II and III reaction to fire class of walls (from outside) defined in columns 2, 4 and 6 in the table is A1 or A2-s1, d0. For buildings within the stability level I, II and III reaction to fire class of fire resistant closing elements defined in columns 3, 5 and 7 in the table is A1 or A2-s1, d0, except for non-substantial parts, gaskets, insulators, glazing (glass) elements (made of glass), of doors and windows (exterior), including those inserted in the curtain walls.

For closed buildings, the specification EW or EI applies for fire resistant parts (doors, windows), depending on the proximity between openings (if less than 1 m mandatory fire performance EI). For open buildings, the

specification *E* may apply in fire resistant elements (doors, windows).

Fire resistance of all elements defined in columns 2, 3, 4, 5, 6 and 7 of the table is in minutes.



R = 15 m (conform distanțe minime de siguranță (m) între compartimente cu nivelul de stabilitate la incendiu IV - V și IV - V)	R = 15 m (according to minimum safety distances (m) between compartments with fire stability level IV – V and IV – V)
R = 12 m (conform distanțe minime de de siguranță (m) între compartimente cu nivelul de stabilitate la incendiu III și IV - V)	R = 12 m (according to minimum safety distances (m) between compartments with fire stability level III and IV – V)
R = 10 m (conform distanțe minime de de siguranță (m) între compartimente cu nivelul de stabilitate la incendiu I - II și IV - V sau între III și III)	R = 10 m (according to minimum safety distances (m) between compartments with fire stability level I – II and IV – V or between III and III)
R = 8 m (conform distanțe minime de de siguranță (m) între compartimente cu nivelul de stabilitate la incendiu I - II și III)	R = 8 m (according to minimum safety distances (m) between compartments with fire stability level I – II and III)
R = 6 m (conform distanțe minime de de siguranță (m) între compartimente cu nivelul de stabilitate la incendiu I - II și I-II)	R = 6 m (according to minimum safety distances, (m) between compartments with fire stability level I – II and I-II)
<b>Compartiment A</b>	<b>Compartment A</b>
perete antifoc conform Art. 2.3.2.1.2 [	fire wall according to Article 2.3.2.1.2 [
<b>Compartiment B</b>	<b>Compartment B</b>
perete rezistent la foc EI/REI în funcție de nivelul de stabilitate la incendiu cu lungime în funcție de nivelul de stabilitate la incendiu al compartimentelor A și B	fire resistant wall EI/REI depending on the level of fire stability with a length depending on the fire stability level of compartments A and B

**Figure 38 - Fire resistant wall (following the fire walls according to Article 2.3.2.1.2) placed externally at the inner corners of civil buildings in the form of L, T or U at an angle  $\alpha$ ,  $\alpha < 90^\circ$**

(2) If the fire walls are placed at the inner corners of civil buildings in the shape of L, T or U at an angle  $\alpha$ ,  $90^\circ \leq \alpha \leq 135^\circ$  (Figure 39), gaps in adjacent external walls shall be arranged in such a way that the distance between them is at least four 4 m and only the fire resistance performance of the outer wall(s) over the distance

of 4 m must be achieved. When operating gaps are provided in this portion, the external walls, as well as functional voids in this portion shall be protected by fire resistant elements according to Table 9 or Table 10.

**Table 9: Fire resistance of external walls and fire-resistant closing elements of functional voids provided in external walls located at the inner corners of civil buildings (with the exception of buildings with persons who cannot evacuate themselves and buildings with crowded rooms) in the form of L, T or U under an angle  $\alpha$ ,  $90^\circ \leq \alpha < 135^\circ$ , where the gaps in adjacent external walls are arranged in such a way that their distance is less than 4 m**

In the case of fire bulkheads separating fire compartments	Thermal load density (q) in perimeter rooms (over a distance of less than 4 m)/construction (MJ/m <sup>2</sup> )	Minimum fire resistance (EI/REI) of external walls – over a minimum distance of 4 m	Fire resistant closing element <sup>2)</sup>
1	2	3	4
For buildings with a height regime ground floor <sup>1)</sup>	for $q \leq 420 \text{ MJ/m}^2$	EI 30/REI 30 (EI 15/REI 15 *)	EI 15 (fixed)
	$420 \text{ MJ/m}^2 < q \leq 630 \text{ MJ/m}^2$	EI 45/REI 45 (EI 30/REI 30 *)	EI 30 (EI 15*)
	$630 \text{ MJ/m}^2 < q \leq 840 \text{ MJ/m}^2$	EI 60/REI 60 (EI 45/REI 45 *)	EI 45 (EI 30*)
	$840 \text{ MJ/m}^2 < q \leq 1\ 680 \text{ MJ/m}^2$	EI 90/REI 90 (EI 60/REI 60 *)	EI 60 (EI 45*)
	$q > 1\ 680 \text{ MJ/m}^2$ (and/or there is a volumetric explosion hazard)	EI 120/REI 120 (EI 90/REI 90 *)	EI 90 (EI 60*)

**Notes:**

<sup>1)</sup> - Refers to 'Fire walls for buildings with ground height regime' as defined in Article 2.3.2.1.2 point (a).

<sup>2)</sup> - Refers to 'Fire resistant closing elements (doors, windows) fitted with self-closing' C' or fixed, if the distance between openings is less than 4 m'.

**Notes:**

For closed buildings, the specification EW or EI applies for fire resistant parts (doors, windows), depending on the proximity between openings (if less than 1 m mandatory for fire performance EI). For open buildings, the specification E may apply in fire resistant elements (doors, windows).

For buildings within the stability level I, II and III, reaction to fire class of walls (from outside) defined in the table is A1 or A2-s1,d0. For buildings within the stability level I, II and III, the reaction to fire class of fire resistant closing elements defined in the table is A1 or A2-s1, d0, except for non-substantial parts, gaskets, insulators, glazing (glass) elements (made of glass), of doors and windows (exterior), including those inserted in the curtain walls.

Fire resistance of all elements defined in columns 3 and 4 of the table is in minutes.

\* The values in brackets shall apply in cases where the rooms are equipped with automatic fire-fighting systems (according to the provisions of Rule P118: 2, except as provided for spaces equipped with other automatic extinguishing systems).

**Table 10: Fire resistance of external walls and fire resistant closing elements of functional voids provided in external walls located at the inner corners of civil buildings (excluding buildings referred to in Article 2.3.2.1.2 (a)) in the form of L, T or U at an angle  $\alpha$ ,  $90^\circ \leq \alpha \leq 135^\circ$ , where the gaps in adjacent external walls are arranged in such a way that their distance is less than 4 m**

Fire stability level	$90^\circ \leq \alpha \leq 135^\circ$					
	In case of fire walls, minimum class EI-M 240/REI 240 <sup>1)</sup>		In the case of fire walls, minimum class EI-M 180/REI 180 <sup>2)</sup>		In the case of fire walls, minimum class EI-M 120/REI 120 <sup>3)</sup>	
	Fire resistance (EI/REI) of external walls <sup>4)</sup>	Fire resistant closing elements <sup>5)</sup>	Fire resistance (EI/REI) of external walls <sup>4)</sup>	Fire resistant closing elements <sup>5)</sup>	Fire resistance (EI/REI) of walls from outside <sup>4)</sup>	Fire resistant closing elements <sup>5)</sup>
1	2	3	4	5	6	7
V	EI/REI 15	fixed	EI/REI 15	fixed	EI/REI 15	fixed

Fire stability level	90° ≤ α ≤ 135°					
	In case of fire walls, minimum class EI-M 240/REI 240 <sup>1)</sup>		In the case of fire walls, minimum class EI-M 180/REI 180 <sup>2)</sup>		In the case of fire walls, minimum class EI-M 120/REI 120 <sup>3)</sup>	
	Fire resistance (EI/REI) of external walls <sup>4)</sup>	Fire resistant closing elements <sup>5)</sup>	Fire resistance (EI/REI) of external walls <sup>4)</sup>	Fire resistant closing elements <sup>5)</sup>	Fire resistance (EI/REI) of walls from outside <sup>4)</sup>	Fire resistant closing elements <sup>5)</sup>
1	2	3	4	5	6	7
IV	EI/REI 30	EI 15	EI/REI 15	EI 15	EI/REI 15	EI 15
III	EI/REI 180 (EI/REI 120*)	EI30	EI/REI 30 (EI/REI 30*)	EI 15	EI/REI 30 (EI/REI 15*)	EI 15 (EI 15*)
II	EI/REI 180 (EI/REI 120*)	EI 45 (EI 30*)	EI/REI 180 (EI/REI 120*)	EI 30 (EI 15*)	EI/REI 45 (EI/REI 30*)	EI 30 (EI 15*)
I h ≤ 28m	EI/REI 180 (EI/REI 120*)	EI 45 (EI 30*)	EI/REI 180 (EI/REI 120*)	EI 30 (EI 15*)	EI/REI 180 (EI/REI 120*)	EI 30 (EI 15*)
I 28m < h < 45m	EI/REI 180 (EI/REI 120*)	EI 60 (EI 45*)	EI/REI 180 (EI/REI 120*)	EI 45 (EI 30*)	-	-
I 45 m ≤ h < 75m	EI/REI 180 (EI/REI 120*)	EI 90 (EI 60*)	EI/REI 180 (EI/REI 120*)	EI 60 (EI 45*)	-	-
I 75m ≤ h < 125m	-	-	EI/REI 120 (EI/REI 90*)	EI 90 (EI 60*)	-	-
I h ≥ 125 m	-	-	EI/REI 180 (EI/REI 120*)	EI 120 (EI 90*)	-	-

**Notes:**

<sup>1)</sup> - Refers to 'Fire walls at least in class EI-M 240/REI 240 for constructions with very high fire risk (when the heat load density (q) is greater than 1 680 MJ/m<sup>2</sup> and/or there is a volumetric explosion hazard)' as defined in Article 2.3.2.1.2 (b).

<sup>2)</sup> - Refers to 'Fire walls at least in class EI-M 180/REI 180 for buildings intended for persons who cannot evacuate themselves (defined according to terminology), for buildings with a high fire risk and for objects, equipment or apparatus of particular importance, for above-ground and/or very high civil buildings or buildings with crowded rooms' as defined in Article 2.3.2.1.2 (c).

<sup>3)</sup> - Refers to 'Fire walls at least in class EI-M 120/REI 120' as defined in Article 2.3.2.1.2 (d).

<sup>4)</sup> - Refers to 'Resistance to fire' (EI/REI) of external walls, for a minimum distance of 4 m'

<sup>5)</sup> - Refers to 'Fire resistant closing elements (doors, windows) fitted with self-closing' C' or fixed, if the distance between openings is less than 4 m'.

**Notes:**

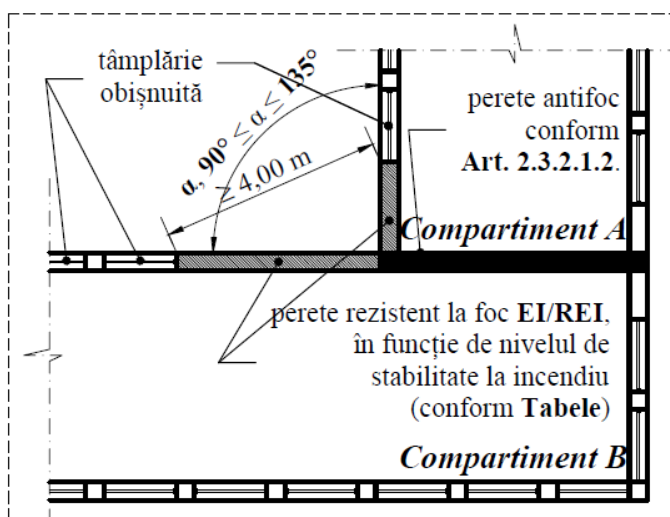
For buildings within the stability level I, II and III reaction to fire class of walls (from outside) defined in columns 2, 4 and 6 in the table is A1 or A2-s1, d0. For buildings within the stability level I, II and III reaction to fire class of fire resistant closing elements defined in columns 3, 5 and 7 of the table is A1 or A2-s1, d0, except for non-substantial parts, gaskets, insulators, glazing (glass) elements (made of glass), of doors and windows (exterior), including those inserted in the curtain walls.

For closed buildings, the specification EW or EI applies for fire resistant parts (doors, windows), depending on the proximity between openings (if less than 1m mandatory fire performance EI). For open buildings, the specification E may apply in fire resistant elements (doors, windows).

Fire resistance of all elements defined in columns 2, 3, 4, 5, 6 and 7 of the table is in minutes.

\* The values in brackets shall apply in cases where the rooms are equipped with automatic fire-fighting systems (according to the provisions of Rule P118: 2, except as provided for spaces equipped with other automatic extinguishing systems).

'h' = elevation of the last accessible/usable floor of the construction from the reference level



tâmplărie obișnuită	ordinary joinery
perete antifoc conform Art. 2.3.2.1.2.	fire wall compliant Article 2.3.2.1.2.
Compartiment A	Compartiment A
perete rezistent la foc EI/REI. în funcție de nivelul de stabilitate la incendiu (conform Tabele)	fire resistant wall EI/REI. depending on the level of fire stability (according to Tables)
Compartiment B	Compartiment B

**Figure 39 - Fire resistant wall (following the fire walls according to Article 2.3.2.1.2) placed externally at the inner corners of civil buildings in the form of L, T or U at an angle  $\alpha$ ,  $90^\circ \leq \alpha < 135^\circ$**

(3) If the fire walls are placed at the inner corners of civil buildings in the shape of L, T or U at an angle  $\alpha$ ,  $\alpha > 135^\circ$  (Figure 40), voids in adjacent external walls shall be arranged in such a way that the distance between them is at least four 4 m and only the fire resistance performance of the outer wall(s) over the distance of 4 m must be achieved. When operating gaps are provided in this portion, the external walls as well as functional voids in this portion shall be protected by fire resistant elements according to Table 11 or Table 12.

**Table 11: Fire resistance of external walls and fire-resistant closing elements of functional voids provided in external walls located at the inner corners of civil buildings (with the exception of buildings with persons who cannot evacuate on their own and buildings with crowded rooms) in the form of L, T or U under an angle  $\alpha$ ,  $\alpha > 135^\circ$ , where the gaps in adjacent external walls are arranged in such a way that their distance is less than 4 m**

In the case of fire bulkheads separating fire compartments	Thermal load density (q) in perimeter rooms (over a distance of less than 4 m)/construction (MJ/m <sup>2</sup> )	Minimum fire resistance (EI/REI) of external walls – over a minimum distance of 4 m	Fire resistant closing element <sup>2)</sup>
1	2	3	4
For buildings with a height regime ground floor <sup>1)</sup>	for q ≤ 420 MJ/m <sup>2</sup>	EI 15/REI 15	fixed
	420 MJ/m <sup>2</sup> < q ≤ 630 MJ/m <sup>2</sup>	EI 30/REI 30 (EI 15/REI 15 *)	EI 15 (fixed)
	630 MJ/m <sup>2</sup> < q ≤ 630 MJ/m <sup>2</sup>	EI 45/REI 45 (EI 30/REI 30 *)	EI 30 (EI 15*)
	840 MJ/m <sup>2</sup> < q ≤ 1 680 MJ/m <sup>2</sup>	EI 60/REI 60 (EI 45/REI 45 *)	EI 45 (EI 30*)
	q > 1 680 MJ/m <sup>2</sup> and/or there is a volumetric explosion hazard)	EI 90/REI 90 (EI 60/REI 60 *)	EI 60 EI 45*

**Notes:**

<sup>1)</sup> - Refers to 'Fire walls for buildings with ground height regime' as defined in Article 2.3.2.1.2 point (a).

<sup>2)</sup> - Refers to 'Fire resistant closing elements (doors, windows) fitted with self-closing' C' or fixed, if the distance between openings is less than 4 m'.

**Notes:**

For closed buildings, the specification **EW** or **EI** applies for fire resistant closing elements (doors, windows), depending on the proximity between openings (if less than 1 m mandatory for fire performance **EI**). For open buildings, the specification **E** may apply in fire resistant elements (doors, windows).

For buildings within the stability level **I**, **II** and **III**, reaction to fire class of walls (from outside) defined in the table is **A1** or **A2-s1,d0**. For buildings within the stability level **I**, **II** and **III**, the reaction to fire class of fire resistant closing elements defined in the table is **A1** or **A2-s1, d0**, except for non-substantial parts, gaskets, insulators, glazing (glass) elements (made of glass), of doors and windows (exterior), including those inserted in the curtain walls.

Fire resistance of all elements defined in columns 3 and 4 of the table is in minutes.

\* The values in brackets shall apply in cases where the rooms are equipped with automatic fire-fighting systems (according to the provisions of Rule P118: 2, except as provided for spaces equipped with other automatic extinguishing systems).

**Table 12: Fire resistance of external walls and fire resistant closing elements of functional voids provided in external walls located at the inner corners of civil buildings (excluding buildings referred to in Article 2.3.2.1.2 (a)) in the form of L, T or U at an angle  $\alpha$ ,  $\alpha > 135^\circ$ , where the gaps in adjacent external walls are arranged in such a way that their distance is less than 4 m**

Fire stability level	$\alpha > 135^\circ$					
	In case of fire walls, minimum class EI-M 240/REI 240 <sup>1)</sup>		In the case of fire walls, minimum class EI-M 180/REI 180 <sup>2)</sup>		In the case of fire walls, minimum class EI-M 120/REI 120 <sup>3)</sup>	
	Fire resistance (EI/REI) of external walls <sup>4)</sup>	Fire resistant closing elements <sup>5)</sup>	Fire resistance (EI/REI) of external walls <sup>4)</sup>	Fire resistant closing elements <sup>5)</sup>	Fire resistance (EI/REI) of walls from outside <sup>4)</sup>	Fire resistant closing elements <sup>5)</sup>
1	2	3	4	5	6	7
V	-	fixed	-	fixed	-	fixed
IV	EI/REI 15	fixed	EI/REI 15	fixed	EI/REI 15	fixed
III	EI/REI 30	EI 15	EI/REI 15	EI 15	EI/REI 15	EI 15
II	EI/REI 180 (EI/REI 120*)	EI 30 (EI 15*)	EI/REI 30 (EI/REI 30*)	EI 15	EI/REI 30 (EI/REI 30*)	EI 15
I h ≤ 28m	EI/REI 180 (EI/REI 120*)	EI 45 (EI 30*)	EI/REI 180 (EI/REI 120*)	EI 30 (EI 15*)	EI/REI 180 (EI/REI 120*)	EI 30 (EI 15*)
I	EI/REI 180	EI 60	EI/REI 180	EI 45	-	-

Fire stability level	$\alpha > 135^\circ$					
	In case of fire walls, minimum class <b>EI-M 240/REI 240</b> <sup>1)</sup>		In the case of fire walls, minimum class <b>EI-M 180/REI 180</b> <sup>2)</sup>		In the case of fire walls, minimum class <b>EI-M 120/REI 120</b> <sup>3)</sup>	
	Fire resistance (EI/REI) of external walls <sup>4)</sup>	Fire resistant closing elements <sup>5)</sup>	Fire resistance (EI/REI) of external walls <sup>4)</sup>	Fire resistant closing elements <sup>5)</sup>	Fire resistance (EI/REI) of walls from outside <sup>4)</sup>	Fire resistant closing elements <sup>5)</sup>
1	2	3	4	5	6	7
$28m < h < 45m$	(EI/REI 120*)	(EI 45*)	(EI/REI 120*)	(EI 30*)		
<b>I</b> $45 m \leq h < 75m$	EI/REI 180 (EI/REI 120*)	EI 60 (EI 45*)	EI/REI 180 (EI/REI 120*)	EI 45 (EI 30*)	-	-
<b>I</b> $75m \leq h < 125m$	EI/REI 180 (EI/REI 120*)	EI 90 (EI 60*)	EI/REI 180 (EI/REI 120*)	EI 60 (EI 45*)	-	-
<b>I</b> $h \geq 125m$	-	-	EI/REI 120 (EI/REI 90*)	EI 90 (EI 60*)	-	-

**Notes:**

<sup>1)</sup> - Refers to 'Fire walls at least in class **EI-M 240/REI 240** for constructions with very high fire risk (when the heat load density ( $q$ ) is greater than **1 680 MJ/m<sup>2</sup>** and/or there is a volumetric explosion hazard)' as defined in **Article 2.3.2.1.2 (b)**.

<sup>2)</sup> - Refers to 'Fire walls at least in class **EI-M 180/REI 180** for buildings intended for persons who cannot evacuate themselves (defined according to terminology), for buildings with a high fire risk and for objects, equipment or apparatus of particular importance, for above-ground and/or very high civil buildings or buildings with crowded rooms' as defined in **Article 2.3.2.1.2 (c)**.

<sup>3)</sup> - Refers to 'Fire walls at least in class **EI-M 120/REI 120**' as defined in **Article 2.3.2.1.2 (d)**.

<sup>4)</sup> - Refers to 'Resistance to fire' (EI/REI) of external walls, for a minimum distance of **4 m**'

<sup>5)</sup> - Refers to 'Fire resistant closing elements (doors, windows) fitted with self-closing' C' or fixed, if the distance between openings is less than **4 m**'.

**Notes:**

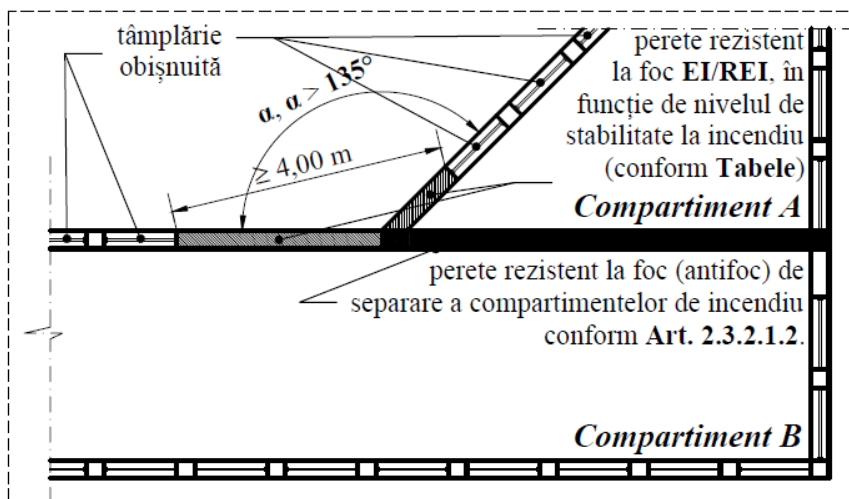
For buildings within the stability level **I**, **II** and **III** reaction to fire class of **walls** (from outside) defined in columns **2**, **4** and **6** in the table is **A1 or A2-s1, d0**. For buildings within the stability level **I**, **II** and **III** reaction to fire class of **fire resistant closing elements** defined in columns **3**, **5** and **7** of the table is **A1 or A2-s1, d0**, except for non-substantial parts, gaskets, insulators, glazing (glass) elements (made of glass), of doors and windows (exterior), including those inserted in the curtain walls.

For closed buildings, the specification **EW** or **EI** applies for fire resistant parts (doors, windows), depending on the proximity between openings (if less than **1m** mandatory fire performance **EI**). For open buildings, the specification **E** may apply in fire resistant elements (doors, windows).

Fire resistance of all elements defined in columns **2**, **3**, **4**, **5**, **6** and **7** of the table is in minutes.

\* The values in brackets shall apply in cases where the rooms are equipped with automatic fire-fighting systems (according to the provisions of Rule **P118: 2**, except as provided for spaces equipped with other automatic extinguishing systems).

'**h**' = elevation of the last accessible/usable floor of the construction from the reference level



tâmplărie obișnuită	ordinary joinery
perete rezistent la foc EI/REI. În funcție de nivelul de stabilitate la incendiu (conform Tabele)	fire resistant wall EI/REI. Depending on the level of fire stability (according to Tables)
<b>Compartiment A</b>	<b>Compartiment A</b>
perete rezistent la foc (antifoc) de separare a compartimentelor de incendiu conform Art. 2.3.2.1.2.	fire resistant (fire wall) bulkhead separating fire compartments according to Article 2.3.2.1.2.
<b>Compartiment B</b>	<b>Compartiment B</b>

**Figure 40 – Fire resistant wall (following the fire walls according to Article 2.3.2.1.2) placed externally at the inner corners of civil buildings in the form of L, T or U at an angle  $\alpha$ ,  $\alpha > 135^\circ$**

(4) If the fire walls are placed at the inner corners of production and storage constructions in the form of L, T or U, voids in adjacent external walls shall be arranged in such a way that the distance between them is at least four 4 m and only the fire resistance performance of the outer wall(s) over the distance of 4 m must be achieved. When operating gaps are provided in this section, the external walls as well as the functional voids in this portion shall be protected by fire resistant elements according to the angle below which they are placed at the inner corners of the constructions, as shown in Table 13 (at an angle  $\alpha$ ,  $\alpha < 90^\circ$ ,  $90^\circ \leq \alpha < 135^\circ$  or  $90^\circ \leq \alpha < 135^\circ$ )

**Table 13: Fire resistance of external walls and fire-resistant closing elements of functional voids provided in the bulkheads (from outside) located at the inner corners of L, T or U-shaped production and storage buildings, where voids in adjacent external walls are arranged in such a way that the distance between them is less than four 4 m**



Notes:

In the case of fire bulkheads separating fire compartments	Thermal load density (q) in perimeter rooms (over a distance of less than 4 m)/construction (MJ/m <sup>2</sup> )	Minimum fire resistance (EI/REI) of external walls – over a minimum distance of 4 m	Fire resistant closing element <sup>2)</sup>
1	2	3	4
<b>When angle <math>\alpha</math>, <math>\alpha &lt; 90^\circ</math></b>			
For production and/or storage buildings <sup>1)</sup>	for $q \leq 420 \text{ MJ/m}^2$	EI 30/REI 30 (EI 15/REI 15 *)	EI 15 (fixed)
	$420 \text{ MJ/m}^2 < q \leq 630 \text{ MJ/m}^2$	EI 45/REI 45 (EI 30/REI 30 *)	EI 30 (EI 15*)
	$630 \text{ MJ/m}^2 < q \leq 840 \text{ MJ/m}^2$	EI 60/REI 60 (EI 45/REI 45 *)	EI 45 (EI 30*)
	$840 \text{ MJ/m}^2 < q \leq 1\,680 \text{ MJ/m}^2$	EI 90/REI 90 (EI 60/REI 60 *)	EI 60 (EI 45*)
	$q > 1\,680 \text{ MJ/m}^2$ (and/or there is a volumetric explosion hazard)	EI 120/REI 120 (EI 90/REI 90 *)	EI 90 (EI 60*)
<b>When angle <math>\alpha</math>, <math>90^\circ \leq \alpha \leq 135^\circ</math></b>			
For production and/or storage buildings <sup>1)</sup>	for $q \leq 420 \text{ MJ/m}^2$	EI 15/REI 15	fixed
	$420 \text{ MJ/m}^2 < q \leq 630 \text{ MJ/m}^2$	EI 30/REI 30 (EI 15/REI 15 *)	EI 15 (fixed)
	$630 \text{ MJ/m}^2 < q \leq 840 \text{ MJ/m}^2$	EI 45/REI 45 (EI 30/REI 30 *)	EI 30 (EI 15*)
	$840 \text{ MJ/m}^2 < q \leq 1\,680 \text{ MJ/m}^2$	EI 60/REI 60 (EI 45/REI 45 *)	EI 45 (EI 30*)
	$q > 1\,680 \text{ MJ/m}^2$ (and/or there is a volumetric explosion hazard)	EI 90/REI 90 (EI 60/REI 60 *)	EI 60 (EI 45*)
<b>When angle <math>\alpha</math>, <math>\alpha &gt; 135^\circ</math></b>			
For production and/or storage buildings <sup>1)</sup>	for $q \leq 420 \text{ MJ/m}^2$	EI 15/REI 15	fixed
	$420 \text{ MJ/m}^2 < q \leq 630 \text{ MJ/m}^2$	EI 15/REI 15	fixed
	$630 \text{ MJ/m}^2 < q \leq 840 \text{ MJ/m}^2$	EI 30/REI 30 (EI 15/REI 15 *)	EI 15 (fixed)
	$840 \text{ MJ/m}^2 < q \leq 1\,680 \text{ MJ/m}^2$	EI 45/REI 45 (EI 30/REI 30 *)	EI 30 (EI 15*)
	$q > 1\,680 \text{ MJ/m}^2$ (and/or there is a volumetric explosion hazard)	EI 60/REI 60 (EI 45/REI 45 *)	EI 45 (EI 30*)

<sup>1)</sup> - Refers to 'production and/or storage buildings' as defined in **Article 7.1.1. paragraph 2**, as well as to 'buildings' defined in **Article 7.1.1. paragraph 3**.

<sup>2)</sup> - Refers to 'Fire resistant closing elements (doors, windows) fitted with self-closing' C' or fixed, if the distance between openings is less than 4 m'.

**Notes Table 13:**

For closed buildings, the specification **EW** or **EI** applies for fire resistant parts (doors, windows), depending on the proximity between openings (if less than 1m mandatory fire performance **EI**). For open buildings, the specification **E** may apply in fire resistant elements (doors, windows).

For buildings within the stability level **I** and **II**, reaction to fire class of **walls** (from outside) defined in the table is **A1** or **A2-s1, d0**. For buildings within the stability level **I** and **II**, reaction to fire class of **fire resistant closing elements** defined in the table is **A1** or **A2-s1, d0**, except for non-substantial parts, gaskets, insulators, glazing (glass) elements (made of glass), of doors and windows (exterior), including those inserted in the curtain walls.

Fire resistance of all elements defined in columns 3 and 4 of the table is in minutes.

\* The values in brackets shall apply in cases where the rooms are equipped with automatic fire-fighting systems (according to the provisions of Rule **P118: 2**, except as provided for spaces equipped with other automatic extinguishing systems).

**Article 2.3.2.1.10. (1)** It is mandatory to ensure the continuation of the conditions for classifying the construction or fire compartment into fire stability levels to the compaction joints with sealing solutions.

**(2)** Any joints between fire resistant walls separating fire compartments and floors, pillars, roofs or perimeter closures of the construction shall be sealed with fire-resistant materials of at least the class **EI 90**. When linear joints are to be classified, different test conditions are defined in the test standard and the class obtained for linear joints is specified by the letters indicating the test conditions given in **SR EN 13501-1**; the sealings of linear joints shall be tested according to **SR EN 1366-4** and extended application must be carried out as described in the Extended Application Standard **SR EN 15882-4** and in **SR EN 15725 (3)**.

**(3)** In the case of perimeter joints of curtain walls (horizontal linear joints sealing), tests shall be carried out according to **SR EN 1364-4** and **SR EN 1364-3** and according to **SR EN 1364-3** in the case of vertical linear joints in the front of curtain walls.

**Article 2.3.2.1.11. (1)** The penetration by metal elements of fire resistant walls separating fire compartments (fire bulkheads) shall only be permitted if measures are taken against the transmission of heat by conductivity (choice of judicious routes, distances from combustible materials, local protection of metallic elements, etc.). Gaps shall be made around the metal elements which penetrate the separation wall to permit their free expansion, sealed by materials in minimum fire-resistant compositions:

- **EI 180** for the situations set out in **Article 2.3.2.1.2 (b) and Article 2.3.2.1.2 (a)** for fire resistant walls corresponding to thermal density values of  $840 \text{ MJ/m}^2 < q \leq 1680 \text{ MJ/m}^2$  according to Table 6;
- **EI 240** for the situations set out in **Articles 2.3.2.1.2 (c) and respectively 2.3.2.1.2 (a)** for fire resistant walls corresponding to thermal density values of  $q > 1680 \text{ MJ/m}^2$  according to Table 6;
- **EI 120** for the situations set out in **Articles 2.3.2.1.2 (d) and respectively 2.3.2.1.2 (a)** for fire resistant walls corresponding to thermal density values of  $630 \text{ MJ/m}^2 < q \leq 840 \text{ MJ/m}^2$  according to Table 6.

**(2)** For the situations set out in **Article 2.3.2.1.2 (a)** with  $q \leq 630 \text{ MJ/m}^2$ , as well as for constructions compliant with **Article 2.1.3.5 (1)**, it shall be prohibited for metal elements to penetrate fire resistant walls separating fire compartments (fire bulkheads).

**(3)** It is not permitted to embed floors in fire walls (**REI**) or other constructional elements having fire resistance less than **R 120** (beams, girders, etc.), only allowing them to resist (free or articulated).

**Article 2.3.2.1.12. (1)** The crossing of fire resistant bulkheads separating fire compartments (fire bulkheads) by ducts, ventilation-conditioning channels, conductors and electric cables shall be permitted only if the sealing/shuttering condition with materials having a minimum fire resistance of the same value as the normal fire resistance of the bulkheads separating the fire compartments according to **Article 2.3.2.1.2**, as follows:

**a)** gaps around ducts, cables, electric conductors, etc., including those mounted in channels, shall be closed with materials of minimum fire resistance **EI** with the same value as the normal fire resistance of the bulkheads separating the fire compartments according to **Article 2.3.2.1.2**;

**b)** ventilation and conditioning channels passing through the fire bulkhead separating the fire compartments according to **Article 2.3.2.1.2** shall be non-combustible on at least **1 m** on both sides of the bulkhead and the gap between the bulkhead and the bulkhead shall be sealed with materials in fire resistant compositions of minimum **EI** with the same value as the normal fire resistance of the bulkheads separating the fire compartments according to **Article 2.3.2.1.2**; in the crossing area, the ventilation-conditioning channels shall be provided with self-closing shutters, dampers, fire resistant to a minimum **EI X (ho i↔o) S**, in which 'X'

has the same value as the normal fire resistance of the walls separating the fire compartments in accordance with **Article 2.3.2.1.2.**;

c) the passage of ducts, ducts and ventilation channels shall be such that they do not cause dislocations of parts of the wall due to their expansion under the effect of temperature;

d) avoidance of ignition of combustible materials in the vicinity of ventilation and conditioning channels, metal ducts and pipes due to the heat transmitted by conductivity (appropriate routing, thermal insulation, etc.) shall be ensured.

e) plastic sewer ducts shall be fitted with automatic closing systems/shutters with minimum fire resistance **EI** with the same value as the normal fire resistance of the bulkheads separating the fire compartments according to **Article 2.3.2.1.2.**

(2) Crossing separation walls provided for protection against fire limiting the propagation within fire compartments by ducts, ventilation and conditioning channels, conductors and electric cables is permitted only if:

a) gaps around ducts, cables, electric conductors, etc., including those mounted in channels, shall be closed with materials having the same fire resistance as the walls on which they intersect (minimum fire resistance provided by **Table 2: Minimum requirements for the classification of the construction or fire compartment into fire stability levels for separations walls provided for protection against fire limiting propagation inside fire compartments**;

b) ventilation and conditioning channels passing through the separation wall shall be non-combustible on at least **1 m** on both sides of the bulkhead and the gap between the bulkhead and the bulkhead shall be sealed with materials in minimum fire resistant compositions **EI** with the same value as the normal fire resistance of the walls it intersects; in the crossing area, the ventilation-conditioning channels shall be provided with self-closing shutters, dampers, fire resistant to a minimum **EI X (ho i↔o) S**, in which 'X' has the same value as the fire resistance of the walls it intersects;

c) the passage of ducts, ducts and ventilation channels shall be such that they do not cause dislocations of parts of the wall due to their expansion under the effect of temperature;

d) avoidance of ignition of combustible materials in the vicinity of ventilation and conditioning channels, metal ducts and pipes due to the heat transmitted by conductivity (appropriate routing, thermal insulation, etc.) shall be ensured.

### **2.3.2.2. Protection of functional voids in fire resistant walls separating fire compartments**

#### **2.3.2.2.1. General provisions**

**Article 2.3.2.2.1.1. (1)** Fire resistant walls separating fire compartments shall be full (without gaps in its surface). The practice of gaps (breakthrough) in these walls is permitted only when the activity or functionality requires them to be provided (for traffic, transport, surveillance, etc.). These gaps shall be protected according to the provisions laid down and the total area of the voids must not exceed **25 %** of that the fire resistant bulkhead separating fire compartments (fire bulkhead).

(2) Gaps in circulation, transport, surveillance, etc. in fire resistant walls separating fire compartments shall be protected by fire resistant fastenings (doors, shutters, curtains, overpressure ventilated buffers or open tambours), according to the provisions of the Rule.

#### **2.3.2.2.2. Doors, shutters, curtains**

**Article 2.3.2.2.2.1. (1)** Fire resistant doors, shutters and curtains that protect functional voids in fire walls (**EI-M 180/REI180**), must be at least **90** minutes fire-resistant, as follows:

a) Fire resistant doors, including their closing devices protecting functional voids in fire resistant walls separating fire compartments (fire bulkheads) **EI-**

**M 180/REI180**), shall be fire-resistant and smoke tight as a minimum **EI<sub>2</sub> 90-C5S<sub>200</sub>**;

b) Fire resistant shutters, including their closing devices that protect functional voids in fire resistant walls separating fire compartments (fire bulkheads **EI-M 180/REI180**), shall be at least **EI<sub>2</sub> 90-C3** fire-resistant;

c) Curtains protecting functional voids in fire resistant walls separating fire compartments (fire bulkheads **EI-M 180/REI180**) shall be at least **EI 90** fire-resistant.

(2) Index ‘C’ means the class of automatic self-closing/closing and shall be specified in the technical design documentation according to Table 1.

(3) Fire resistant doors, shutters and curtains that protect functional voids in fire walls lower than **EI-M180/REI180** must have a fire resistance of not less than half that of the fire wall, without being less than **EI<sub>2</sub> 60-C5S<sub>200</sub>**.

### 2.3.2.2.3. Buffer rooms

**Article 2.3.2.2.3.1. (1)** Circulation gaps in fire resistant bulkheads separating fire compartments (fire bulkheads) may be protected by protected buffer rooms.

(2) Protected buffer rooms (overpressure ventilated or fitted with mechanical air intake and mechanical smoke discharge) provided in fire bulkheads or fire resistant walls shall meet the following conditions:

a) the minimum fire resistance of walls shall be minimum **EI/REI 60** and floors **REI 60**, according to Table 14;

b) for the functional circulation and escape of users, only strictly necessary voids are permitted in the walls of protected buffer rooms;

c) gaps for functional circulation and escape in walls of protected buffer rooms shall be equipped with fire resistant and smokeproof doors according to the provisions of the legislation, i.e. **EI<sub>2</sub>30-C5S<sub>200</sub>**, **EI<sub>2</sub>45-C5S<sub>200</sub>**, **EI<sub>2</sub>60-C5S<sub>200</sub>**, **EI<sub>2</sub>90-C5S<sub>200</sub>**, **EI<sub>2</sub>120-C5S<sub>200</sub>**, and when the regulation does not provide, they will be minimal according to the provisions of Table 14.

**Table 14: Walls and floors in protected buffer rooms and gaps for functional circulation and escape provided in walls of buffer rooms**

<i>In the case of fire bulkheads separating fire compartments</i>	<i>Fire resistance of fire bulkheads separating fire compartments</i>	<i>Minimum fire resistance (EI/REI) of walls of the buffer room(minutes), excluding bulkhead separating fire compartments</i>	<i>Minimum fire resistance (REI) of the buffer room floor</i>	<i>Fire resistant doors</i>
<i>a) for buildings with ground floor rise, with the exception of buildings intended for persons who cannot evacuate themselves and buildings with crowded rooms determined according to the density of the heat load, according to Table 6</i>	<b>EI-M 60/REI 60</b> ( $q \leq 420 \text{ MJ/m}^2$ )	<b>EI 60/REI 60</b>	<i>In accordance with the provisions of Table 2 – point 3 Minimum fire resistance requirements to be met by floors (REI) in order to meet the established fire stability level, not less than REI 60.</i>	<b>2 doors x EI<sub>2</sub> 60-C5S<sub>200</sub></b>
	<b>EI-M 90/REI 90</b> ( $420 \text{ MJ/m}^2 < q \leq 630 \text{ MJ/m}^2$ )	<b>EI 60/REI 60</b>		<b>2 doors x EI<sub>2</sub> 60-C5S<sub>200</sub></b>
	<b>EI-M 120/REI 120</b> ( $630 \text{ MJ/m}^2 < q \leq 840 \text{ MJ/m}^2$ )	<b>EI 60/REI 60</b>		<b>2 doors x EI<sub>2</sub> 60-C5S<sub>200</sub></b>
	<b>EI-M 180/REI 180</b> ( $840 \text{ MJ/m}^2 < q \leq 1\ 680 \text{ MJ/m}^2$ )	<b>EI 90/REI 90</b>		<b>2 doors x EI<sub>2</sub> 90-C5S<sub>200</sub></b>
	<b>EI-M 240/REI 240</b> ( $q > 1\ 680 \text{ MJ/m}^2$ )	<b>EI-M 120/REI 120</b>		<b>REI 120</b>

	(and/or there is a volumetric explosion hazard)			<b>C5S<sub>200</sub></b>
b) for buildings intended for persons who cannot evacuate themselves, for buildings with a high fire risk, as well as for objects, equipment or apparatus of particular importance, for above-ground and/or very high civil buildings or buildings with crowded rooms	<b>EI-M 180/REI 180</b>	<b>EI 90/REI 90</b>	<b>REI 90</b>	<b>2 doors x EI<sub>2</sub> 90-C5 S<sub>200</sub></b>
c) constructions with very high fire risk (when density of heat load (q) is greater than 1 680 MJ/m <sup>2</sup> and/or there is a volumetric explosion hazard)	<b>EI-M 240/REI 240</b>	<b>EI-M 120/REI 120</b>	<b>REI 120</b>	<b>2 doors x EI<sub>2</sub> 120-C5S<sub>200</sub></b>
d) buildings of a different rise, with the exception of buildings as defined in points (a), (b) and (c) of the table	<b>EI-M 120/REI 120</b>	<b>EI 60/REI 60</b>	<b>In accordance with the provisions of Table 2 – point 3 Minimum fire resistance requirements to be met by floors (REI) in order to meet the established fire stability level, not less than REI 60.</b>	<b>2 doors x EI<sub>2</sub> 60-C5S<sub>200</sub></b>

**d)** as far as possible, buffer rooms shall be attached to the fire resistant wall and shall be provided in spaces with smaller heat load density (**q**); buffer rooms delineating areas with a volumetric explosion hazard shall be required to be located outside the area exposed to the explosion;

**e)** buffer rooms shall be provided with independent overpressure ventilation systems or with air inlet and smoke discharge;

**f)** where protected buffer rooms are provided with excess pressure ventilation installations, the pressure on the closed doors shall not exceed **80 Pa**; The calculation criterion used will be the appropriate class **SR EN 12101-13** –Smoke and heat control systems. Part 13: Pressure differential systems (PDS). Design and calculation methods, installation, acceptance testing, routine testing and maintenance, and **SR EN 12101-6** –Smoke and heat control systems. Part 6: Specification for pressure differential systems. Kits;

**g)** wall and floor finishes shall be at least **A2-s1d0**, respectively **A2fl-s1**.

**h)** buffer rooms shall have a minimum surface area of **3 sqm** and the distance between door actuating handles shall be minimum **2 m**.

**i)** the minimum fire resistance of the walls of the protected buffer rooms provided for in fire resistant walls established in the Rule shall be ensured according to the specific provisions of the Rule. Where the minimum fire resistance of walls is not included in the Rule, for the doors of the required buffer rooms, their walls (except the wall to the room with thermal load density or risk) shall ensure:

- minimum resistance to fire **(EI/REI)** of the buffer room walls **EI 60/REI 60** fitted with doors **EI<sub>2</sub> 30-C5S<sub>200</sub>**
- minimum resistance to fire **(EI/REI)** of the buffer room walls **EI 90/REI 90** fitted with doors **EI<sub>2</sub> 45-C5S<sub>200</sub>**
- minimum resistance to fire **(EI/REI)** of the buffer room walls **EI 120/REI 120** fitted with doors **EI<sub>2</sub> 60-C5S<sub>200</sub>**

**j)** the minimum fire resistance of protected buffer rooms walls provided in fire resistant walls to production and/or storage structures (excluding the wall to the room with thermal load density or risk of volumetric explosion) shall be minimum **EI/REI 90** and the doors of the buffer room shall be have minimum **EI<sub>2</sub>90-C5S<sub>200</sub>**;

#### 2.3.2.2.4. Open tambours

**Article 2.3.2.2.4.1. (1)** In cases where, due to functional or technological needs, it is not possible to protect voids in fire resistant bulkheads separating fire compartments (fire bulkheads) with protected doors, shutters, curtains or buffers, open tambours may be provided.

**(2)** Open tambours protecting gaps in fire resistant bulkheads separating fire compartments (fire bulkheads) shall meet the following requirements:

- a)** the width of the tambour shall be equal to that of the protected gap and the length shall be at least **4 m**;
- b)** side walls and tambour floors shall be free of gaps, with fire resistance of minimum **EI/REI 60** for walls and **REI 60** for floors, according to the provisions of Table 15;
- c)** an automatic and/or manual sprinkler (drainage) shall be provided in the tambour in the event of fire, one for each **1 m<sup>2</sup>** of a horizontal tambour surface, with a minimum total water flow **20,5 L/s** for every **2** and operating time according to the corresponding rules, but minimum **60 minutes** (according to the operating time set out in Table 15);
- d)** tambours may be placed fully allotted on either side of the fire or interleaved bulkhead on either side of the fire bulkhead), respecting the width prescribed in **point (a)**.

**Table 15: Walls and floors in open tambours and their fitting**

<i>In the case of fire bulkheads separating fire compartments</i>	<i>Fire resistance of fire bulkheads separating fire compartments</i>	<i>Minimum fire resistance (EI/REI) of open tambour walls (minutes), excluding bulkhead separating fire compartments</i>	<i>Minimum fire resistance (REI) of the open tambour floor</i>	<i>Equipment with open sprinkler installations – operating time (minutes)</i>

a) for buildings with ground floor rise, with the exception of buildings intended for persons who cannot evacuate themselves and buildings with crowded rooms determined according to the density of the heat load, according to <b>Table 6</b>	<b>EI-M 60/REI 60</b> ( $q \leq 420 \text{ MJ/m}^2$ )	<b>EI 60/REI 60</b>	<b>In accordance with the provisions of Table 2 – point 3 and Table 3 – point 3</b> Minimum fire resistance requirements to be met by floors (REI) in order to meet the established fire stability level, not less than <b>REI 60</b> .	<b>60</b>
	<b>EI-M 90/REI 90</b> ( $420 \text{ MJ/m}^2 < q \leq 630 \text{ MJ/m}^2$ )	<b>EI 60/REI 60</b>		
	<b>EI-M 120/REI 120</b> ( $630 \text{ MJ/m}^2 < q \leq 840 \text{ MJ/m}^2$ )	<b>EI 60/REI 60</b>		<b>90</b>
	<b>EI-M 180/REI 180</b> ( $840 \text{ MJ/m}^2 < q \leq 1 680 \text{ MJ/m}^2$ )	<b>EI 90/REI 90</b>		
	<b>EI-M 240/REI 240</b> ( $q > 1 680 \text{ MJ/m}^2$ (and/or there is a volumetric explosion hazard))	<b>EI-M 120/REI 240</b>		
b) for buildings intended for persons who cannot evacuate themselves (defined according to terminology), for buildings with a high fire risk and for objects, equipment or apparatus of particular importance, for above-ground and/or very high civil buildings or buildings with crowded rooms	<b>EI-M 180/REI 180</b>	<b>EI 90/REI 90</b>	<b>90</b>	
c) constructions with very high fire risk (when density of heat load ( $q$ ) is greater than <b>1 680 MJ/m<sup>2</sup></b> and/or there is a volumetric explosion hazard)	<b>EI-M 240/REI 240</b>	<b>EI-M 120/REI 120</b>	<b>90</b>	
d) buildings of a different rise, with the exception of buildings as defined in points (a), (b) and (c) of the table	<b>EI-M 120/REI 120</b>	<b>EI 60/REI 60</b>	<b>60</b>	

### 2.3.2.3. Fire resistant floors for the separation of fire compartments

**Article 2.3.2.3.1. (1)** Floors are horizontal or inclined building elements delineating enclosed spaces in buildings.

**(2)** Floors may constitute fire-resistant separating fire compartments (fire floors) in high, very high or underground buildings (independent underground buildings, underground parking areas), when they are fire-resistant (**REI**) according to the provisions of the Rule and do not have internal gaps or the gaps inside them are protected by appropriate closing elements.

**Article 2.3.2.3.2.** Functional voids in fire resistant floors (**REI**) shall be protected with fire resistant elements (**EI**), according to the provisions of the Rule.

**Article 2.3.2.3.3.** Horizontal building elements (floors) delineating the fire compartments shall be made of products which provide a standardised fire resistance as described in Table 5, but

not less than **REI 120**, being located, constructed and dimensioned in such a way as to resist the effects of fires in the fire compartments they separate.

### ***2.3.3. Fire resistant partitions inside fire compartments and protection of functional voids thereof***

#### ***2.3.3.1. General provisions***

**Article 2.3.3.1.1.** Depending on the highest density of the heat load (**q**) in the rooms they separate, the walls, where applicable, the floors and their operating gaps within the fire compartments, shall ensure that fire propagation is contained.

**Article 2.3.3.1.2.** For cases where the Rule does not establish standardised fire resistances (**REI**) for partitions and separation floors within fire compartments with elements meeting the reaction-to-fire conditions specific to the destination and type of building, their resistances shall be ensured according to the level of fire stability of the construction, the density of the heat load (**q**) of adjacent rooms (according to **Article 2.3.1.2.**) and the role of the separation element in the event of fire.

#### ***2.3.3.2. Fire resistant walls inside fire compartments***

**Article 2.3.3.2.1. (1)** Structural walls **REI** shall be used to limit the spread of fire inside a fire compartment and/or partition walls **EI** shall be provided in both directions which may also have a sinuous route, and/or be shifted vertically.

**(2)** Walls **REI** or **EI** designed to limit the spread of fire within a fire compartment shall be carried out according to the standard conditions specific to the type/purpose of the building. For cases where the Rule does not establish standardised fire resistances (**REI/EI**) for these walls inside fire compartments, their resistances shall be ensured according to the density of the heat load (**q**) of adjacent rooms in conjunction with the classification of the construction to the level of fire stability or destination in the case of spaces treated as open spaces (work – for administrative or other function as intended for operation), for activities requiring frequent communication or spaces with the same fire risk and destination (own or complementary).

**(3)** When fire resistant elements are found in the specific destinations detailed in the Rule, the composition of the **REI/EI** walls shall meet the most stringent performance conditions laid down in the Rule for those functions.

**Article 2.3.3.2.2.** In order to limit the spread of fire in buildings, for rooms or fire compartments which are specified in the Rule, it is mandatory to provide for an exhaust system for hot smoke and gases, according to its provisions

#### ***2.3.3.3. Fire resistant floors inside fire compartments***

**Article 2.3.3.3.1.** In buildings and fire compartments, the separation of the following shall be ensured:

- a)** rooms within civil buildings and civil fire compartments according to the provisions on common and specific performance, according to each building fire category, type, operation and destination, corresponding to the density of the heat load (**q**) in adjacent rooms;
- b)** rooms within production and/or storage buildings and civil fire compartments according to the provisions on common performance and those specific to production and/or storage buildings, corresponding to the density of the heat load (**q**) in adjacent rooms.



#### **2.3.3.4. Protection of gaps in fire resistant walls and fire resistant floors inside fire compartments**

**Article 2.3.3.4.1. (1)** Protection of operating and escape gaps in fire resistant walls (**EI** or **REI**, if applicable) and fire resistant floors (**REI**) shall be ensured according to the conditions laid down in the Rule and in the specific technical regulations.

**(2)** Index 'C' means the class of automatic self-closing/closing and shall be specified in the technical design documentation according to Table 1.

**Article 2.3.3.4.2. (1)** In buildings and fire compartments, communication and functional movement and escape gaps in the partitions separating rooms from the rest of the construction shall be protected according to the provisions of the Rule.

**(2)** In technically justified cases where fire resistant constructions cannot be used, the protection of gaps in the floor may be ensured by providing continuous screens on the outline of the gap of minimum **DH 60** for level of **I** and **II** of fire stability and minimum **DH 30** for other levels of fire stability with a minimum height of **50 cm** (placed under the floor) and with appropriate positioned sprinkler curtains with a minimum service life of **60** minutes (according to the provisions of Rule **P118: 2**), provided that the construction is fitted with such facilities.

**Article 2.3.3.4.3. (1)** In attic constructions, the gaps provided in the attic floors shall be protected by normally closed, fire resistant closing elements:

- **EI 60** for level **I** of fire stability;
- **EI 45** for level of **II** of fire stability;
- **EI 30** for level **II** of fire stability;
- **EI 20** for level **IV** of fire stability.

**(2)** In order not to take into account the roof framing and the covering support of the constructions with an attic, they must satisfy the conditions laid down in **Article 2.1.3.4 point (a)**.

#### **2.3.4. Fire resistant and volumetric explosion resistant elements and protection of functional voids thereof**

##### **2.3.4.1. General provisions**

**Article 2.3.4.1.1.** Rooms, compartments, buildings and areas at risk of volumetric explosion shall be specified in the technical documentation, taking into account the possibility of mixtures of air with gases, vapours or fuel dust in concentrations presenting an explosion hazard during the normal operation of the related utility installations.

**Article 2.3.4.1.2. (1)** The composition and dimensioning of building elements resistant to volumetric explosion shall be determined by calculation in such a way that they do not collapse under the effect of overpressure occurring in the event of volumetric explosion in the respective rooms, depending on the surfaces of decompression provided (windows, folding panels, skylights, flying roofs, etc.).

**(2)** Fire and explosion resistant construction elements shall also prevent the propagation of fire from adjacent spaces to rooms with a volumetric explosion hazard. Wall fire resistances (**REI**) and floors (**REI**) shall be determined according to the density of the heat load (**q**) in adjacent rooms, according to the provisions of the Rule.

**Article 2.3.4.1.3. (1)** The roof of buildings and rooms at risk of volumetric explosion must not be provided with an attic.

**(2)** Self-supporting or suspended ceilings and non-ventilated areas to facilitate the production of dangerous air concentrations of gases, vapours or fuel dust shall not be permitted, and in fuel dust release rooms, the finishes must permit easy cleaning of their surfaces.

(3) The wear layer of floor coverings and plinths shall be made of materials which by impact do not cause sparks capable of initiating ignition of explosive mixtures. The floor coverings and plinths of the enclosure shall be electrostatically conductive and in the case of flammable liquids, they shall be designed in a way that is impermeable to liquids.

(4) The joinery, including its actuating systems, shall be certified according to the ATEX Directive.

**Article 2.3.4.1.4. (1)** Gaps shall be provided for decompression in case of explosion with the total area  $A_{ex}$  arranged in external walls or in a roof of at least  $0.05 \text{ m}^2$  at  $1 \text{ m}^3$  of the volume of that room. The adoption of a lower percentage is permitted on the basis of a supporting calculation, showing that the stability of the building is not thereby affected.

(2) The load-bearing structures of spaces at risk of explosion shall be designed in such a way that the destruction of their individual elements cannot lead to progressive collapse.

(3) Whether the areas of the pressure discharge zones (of the decompression voids in the event of explosion) as described in paragraph 1 are used, then the static load of  $3 \text{ kN/m}^2$  which applies to primary load-bearing structures shall be applied in all directions within the interior space as an extraordinary load.

(4) Decompression voids in the event of explosion shall be located in the vicinity of the likely sources of volumetric explosion, taking into account that the effect of explosion outside the construction does not affect neighbouring constructions or public traffic routes.

(5) Gaps provided for decompression may be open or closed. The fastenings shall fail under explosion pressure and may consist of lightweight panels or parts of walls or roof (removable or folding), windows and/or skylights with a single glazing not exceeding  $3 \text{ mm}$  thickness (non-reinforced).

6. Rooms in which thermal power stations are located (in which appliances burning gaseous fuels are fitted) shall be provided with gaps for decompression in the event of explosion according to the specific regulations (glazed surfaces: windows, glazed lights, doors incorporating windows or holes or similar surfaces therefor: panels which according to the technical specification given by manufacturers fail under explosion pressures of at least  $1 \text{ 180 IP} = 0.0118 \text{ bar}$ ). The rooms in which thermal power plants are located shall be considered as having a medium risk of fire.

**Article 2.3.4.1.5. (1)** Loads applicable to fire and explosion resistant walls (in the absence of specific calculations) separating spaces of very high fire risk and volumetric explosion can be considered as:

a)  $6 \text{ kN/m}^2$  if the distance between the deflector wall and the explosion resistant wall is within the range of  $[3 \text{ m} - 5 \text{ m}]$ ;

b)  $5 \text{ kN/m}^2$  if the distance between the deflector wall and the explosion resistant wall is within the range of  $(5 \text{ m} - 10 \text{ m})$ ;

c)  $3 \text{ kN/m}^2$  if the distance between the deflector wall and the explosion resistant wall is within the range  $(10 \text{ m} - 20 \text{ m})$ ;

d)  $1 \text{ kN/m}^2$  if the distance between the deflector wall and the explosion resistant wall is  $>20 \text{ m}$ ;

(2) Wall dimensions shall be designed for the static load applied in the direction of decompression voids in the event of explosion. Due to the effect of negative pressure,  $20 \%$  of loads must be considered in the opposite direction to ventilation.

(3) The loads applicable to explosion resistant walls shall be calculated by persons certified on mechanical strength.

### **2.3.4.2. Fire resistant and volumetric explosion resistant walls**

**Article 2.3.4.2.1.** Walls separating rooms of very high fire risk and volumetric explosion from the rest of the construction shall be free of gaps, resistant to fire and explosion, with the exception of functional voids.

**Article 2.3.4.2.2.** Fire resistant walls separating spaces of very high fire risk and volumetric explosion shall meet both fire resistance and volumetric explosion resistance requirements (**REI**, reaction class to fire **A1**).

### ***2.3.4.3. Protection of functional voids in fire resistant and volumetric explosion resistant walls***

**Article 2.3.4.3.1. (1)** The use of gaps in fire resistant and volumetric explosion resistant walls or wall penetration by ducts, tubes, cables, etc. shall be permitted only in exceptional cases required by functional or technological needs and only if the protective measures provided for in the Rule and specific regulations are taken.

**(2)** The functional communication gaps provided in fire resistant and volumetric explosion resistant walls shall be protected by buffer rooms ventilated under excess pressure. The same shall apply for communication between rooms with a volumetric explosion hazard, in cases where direct communication would prejudice fire safety or when rooms are located in different fire compartments.

**(3)** Protected buffer rooms ventilated under overpressure for the protection of gaps in the volumetric explosion resistant walls shall be carried out in the same way as those referred to in fire resistant bulkheads separating fire compartments (fire walls) and are recommended to be located towards less hazardous spaces.

**(4)** Doors of the protected buffer room shall be at least fire-resistant **EI<sub>1</sub> 90-C5S<sub>200</sub>** and shall be certified according to the ATEX Directive. The protected buffer rooms shall be ventilated under permanent excess pressure, having at least **50 Pa**.

**(5)** In buffer rooms ventilated under excess pressure which protect gaps of communication between spaces where releases of gases, vapours or dust with a volumetric explosion hazard occur, measures shall be taken to prevent release from one side to the other during normal operation.

### ***2.3.4.4. Fire resistant and volumetric explosion resistant floors***

**Article 2.3.4.4.1.** Floors resistant to fire and volumetric explosion, as well as their supporting elements, shall be sized and constructed in such a way that they are not dislocated from the blast of the explosion.

**Article 2.3.4.4.2.** Fire resistant floors separating spaces of very high fire risk and volumetric explosion shall meet both fire resistance and volumetric explosion resistance requirements (**REI**, reaction class to fire **A1**).

### ***2.3.5. Fire tight elements***

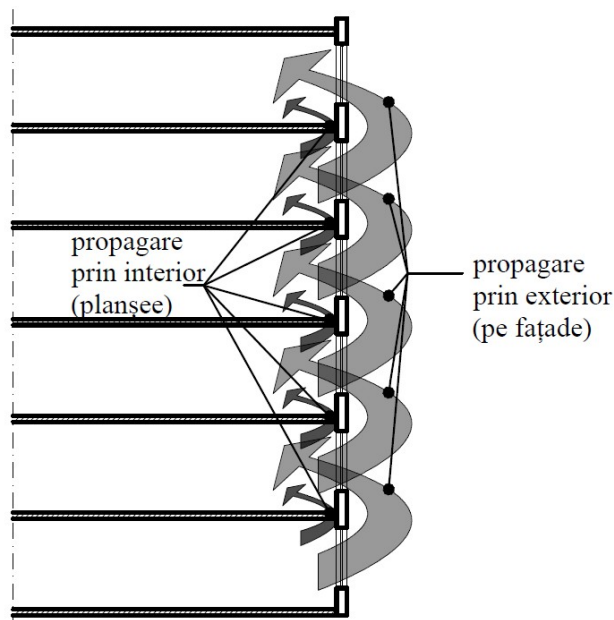
**Article 2.3.5.1. (1)** Horizontal or vertical protection fire tight elements (**E**) must meet the requirements of the Rule, being provided in the cases and conditions laid down in the Rule and the specific technical regulations.

**(2)** Gaps in fire-tight building elements shall be protected by fire tight doors, shutters or curtains (**E**), according to the provisions of the Rule and the specific technical regulations.

### ***2.3.6. Limiting the spread of fire on the facade and roof***

#### ***2.3.6.1. General provisions on limiting propagation on the facade***

**Article 2.3.6.1.1.** Perimeter closures of any kind of constructions shall be formed and carried out in such a way as to delay the spread of fires from one level to another, both outside the perimeter closure (on the facade) and through the interior of the construction (Figure 41).



propagare prin interior (planșee)	internal propagation (floors)
propagare prin exterior (pe fațade)	external propagation (on facades)

**Figure 41 - Spread of fires from one level to another (on the facades or through the interior)**

**Article 2.3.6.1.2. (1)** One of the following solutions shall be adopted to delay the spread of fires between building levels:

- a. joinery with glazed elements without fire performance mounted on parapets - external (non-load-bearing) walls and/or parts of external (non-load-bearing) fire-resistant walls classified from outside to inside (**o** → **i**);
- b. continuous areas in the plane of the curtain wall, fire resistant classified from outside to the inside (**o** → **i**);
- c. fire resistant curtain wall or joinery panel (minimum **EI30**, in full (**o** ↔ **i**));
- d. classified continuous protection areas (screens) **D<sub>600</sub>** or **DH**;
- e. active fire extinguishing systems (water curtain) located inside, at a maximum distance of **30 cm** from the perimeter closure.

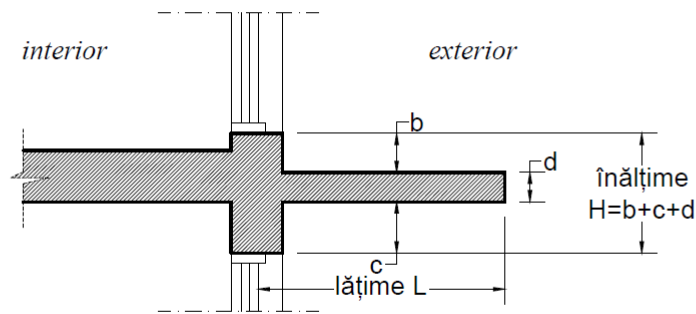
Gaps between the floor and the curtain wall shall be sealed by classified fire resistant sealing systems having the same fire resistance as the floor, but not more than **120** minutes.

**(2)** Vertical zones for delaying fire propagation outside perimeter closures of the construction (on the faade) may be replaced by continuous horizontal external fire resistant zones classified by the criterion **RE** if they are non-trafficable or **REI** if trafficable.

**(3)** The passive measures foreseen to delay the spread of fires outside the perimeter closure (on the faade), as well as through the interior of the construction shall have fire resistance greater than or equal to **30** minutes, with the exceptions provided for (housing buildings representing individual units and condominium consisting of one or more constructions, with a height of **h** < **8 m**, where ‘**h**’ represents the elevation of the last accessible floor of the construction compared to the reference level).

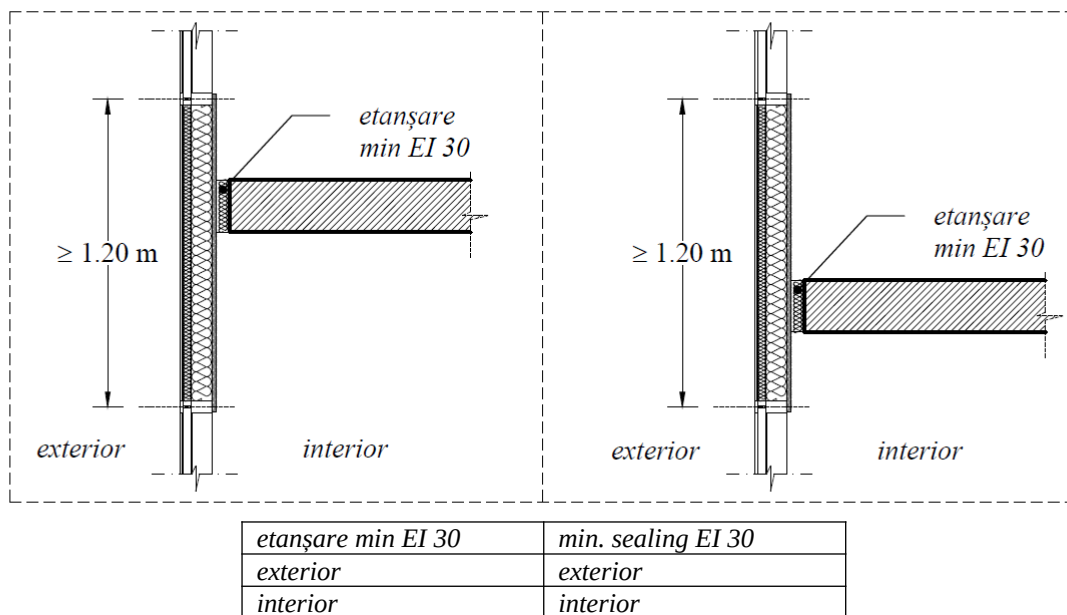
**(4)** The anchorage to the building structure of the curtain walls must comply with the curtain wall conditions laid down in the technical sheets of the specific quality documents.

**(5)** In cases where explicitly stated, the vertical elements may be added to horizontal elements having the same fire resistance (same time period) according to **Table 42** and in cases where summation is not allowed, measures shall be taken according to **Figure 43** or according to specific cases.



interior	interior
exterior	exterior
înălțime $H=b+c+d$	height $H = b + c + d$
lățime $L$	width $L$

**Figure 42 – Concept summing vertical elements with horizontal elements having the same fire resistance (general case)**



etansare min EI 30	min. sealing EI 30
exterior	exterior
interior	interior

**Figure 43 – Concept in which elements are not allowed to be added together**

(example: specific case curtain walls: continuous areas with a height of at least 1.20 m measured vertically, fire resistant of minimum EI 30 (o → i), placed in the plane of the curtain wall)

**Article 2.3.6.1.3. (1)** To delay the propagation of fires between building levels outside the perimeter closure (on the facade) and through the interior of the constructions of:

– buildings:

- with crowded rooms,
- with persons who cannot evacuate themselves,
- with temporary accommodation operation,
- pre-primary, primary and secondary education

with height  $h \geq 8 \text{ m}$  (where ‘ $h$ ’ represents the elevation of the last useable building floor compared to the reference level)

and

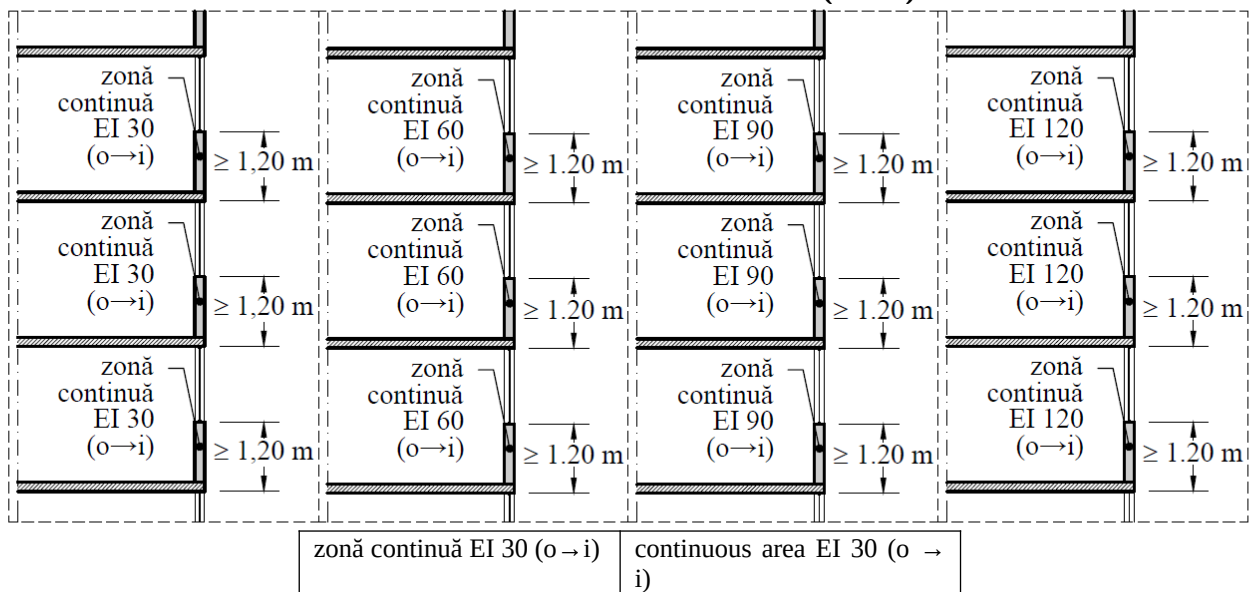
– buildings with other functions than those listed above with  $\geq P + 5E$  rise or with height  $h \geq 20 \text{ m}$  (where ‘ $h$ ’ is the elevation of the last useable building floor compared to the reference level),

one of the following measures may be adopted:

a. External walls (non-bearing) and/or parts of external walls resistant to the fire outbreaks that include joinery with non-fire-performance glazed elements (Figure 44) shall meet the following criteria:

- in buildings of normal height:

- i. height of at least **1.20 m**
  - (and)
  - ii. minimum fire resistance **EI 30 (o → i)**;
- in high buildings:
  - i. height of at least **1.20 m**
  - (and)
  - ii. minimum fire resistance **EI 60 (o → i)**;
- in very high buildings below the height of **125 m**:
  - i. height of at least **1.20 m**
  - (and)
  - ii. minimum fire resistance **EI 90 (o → i)**;
- in very high buildings with a height greater than or equal to **125 m**:
  - i. height of at least **1.20 m**
  - (and)
  - ii. minimum fire resistance **EI 120 (o → i)**.



a) in buildings of normal height

b) in high buildings

c) in very high buildings below the height of 125 m:

d) in very high buildings with a height greater than or equal to 125 m

**Figure – 44 – Performance of external walls (non-bearing) and/or parts of fire resistant external walls including glazed elements**

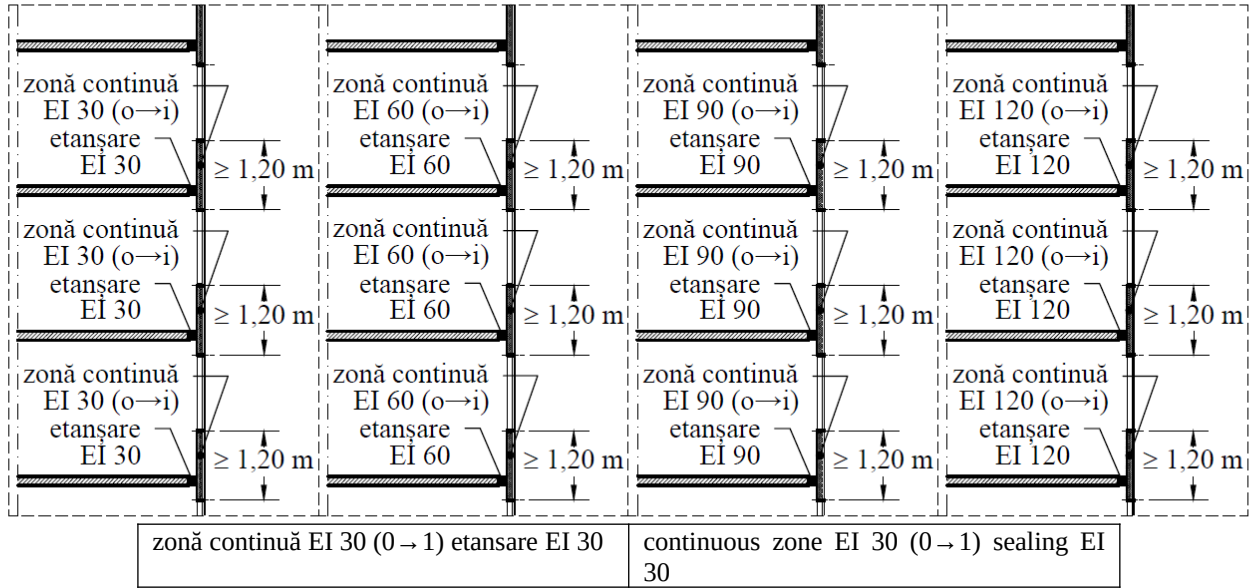
b. continuous areas in the plane of the curtain wall (Figure 45) shall meet the following criteria:

- in buildings of normal height:
  - i. height of at least **1.20 m**
  - (and)
  - ii. minimum fire resistance **EI 30 (o → i)**;
- in high buildings:
  - i. height of at least **1.20 m**
  - (and)
  - ii. minimum fire resistance **EI 60 (o → i)**;
- in very high buildings below the height of **125 m**:
  - i. height of at least **1.20 m**
  - (and)
  - ii. minimum fire resistance **EI 90 (o → i)**;
- in very high buildings with a height greater than or equal to **125 m**:

i. height of at least **1.20 m**

(and)

ii. minimum fire resistance **EI 120 (o → i)**.



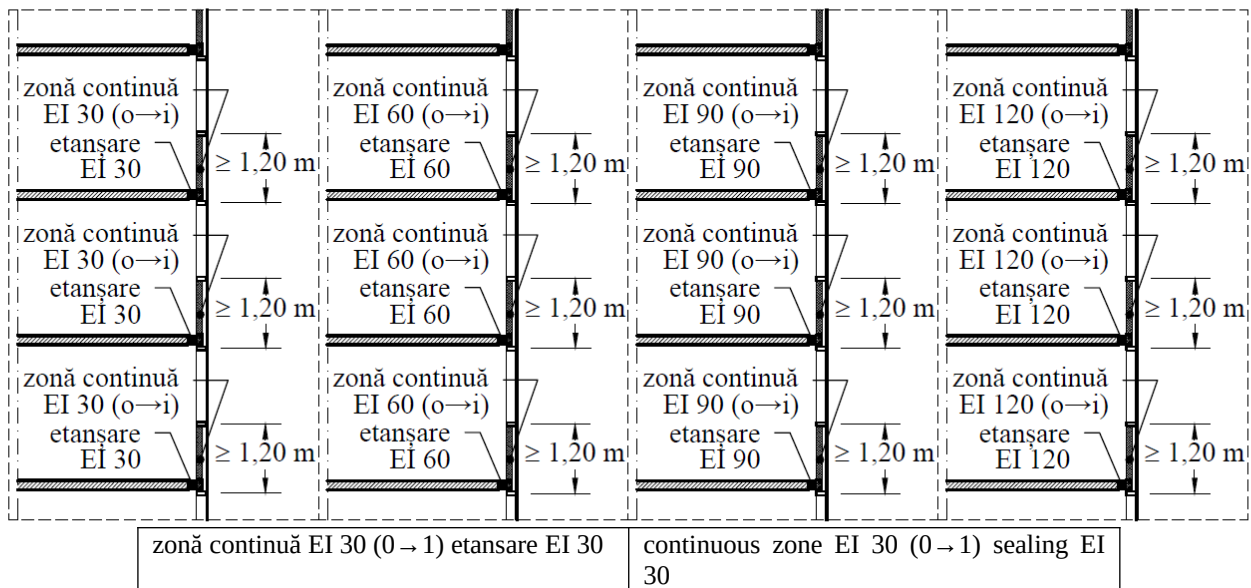
e) in buildings of normal height

f) in high buildings

g) in very high buildings below the height of 125 m:

h) in very high buildings with a height greater than or equal to 125 m

**Variant 1): Performance of continuous areas (indoor and outdoor area) arranged in the plane of the curtain wall**



a) in buildings of normal height

b) in high buildings

c) in very high buildings below the height of 125 m:

d) in very high buildings with a height greater than or equal to 125 m

**Variant 2): Performance of continuous zones (opaque indoor and outdoor transparent area) arranged in the plane of the curtain wall**

**Figure 45 - Performance of continuous zones of at least 1.20 m height arranged in the plane of the curtain wall**

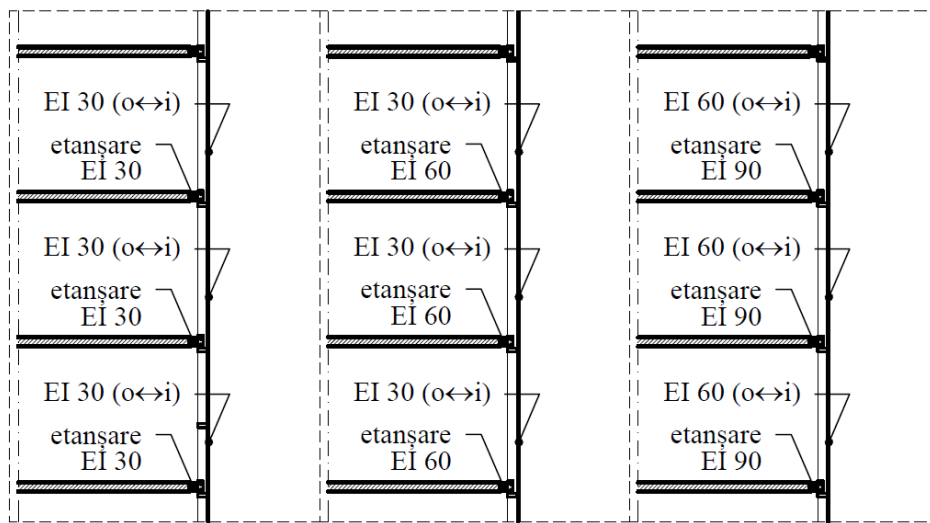
**Note Figure 46:** The continuous zone EI x (o → i) is inserted into the curtain walls, being a constructive part of the curtain wall and attached to the curtain wall mainly and additionally to the floor of the building

c. curtain wall or joinery panel (Figure 46) shall meet the following criterion (on its full height):

- in buildings of normal height:
  - i. minimum fire resistance **EI 30 (o ↔ i)**;
- in high buildings:
  - i. minimum fire resistance **EI 30 (o ↔ i)**;
- in very high buildings:
  - i. minimum fire resistance **EI 30 (o ↔ i)**;

**Notes:** 1) for fire resistant closing elements of functional voids provided in bulkheads (from outside) located at the inner corners of civil buildings works in the shape of **L, T** or **U**, the values set out in Table 7, Table 8 Table 9 Table 10 Table 11 and Table 12 shall be used and for fire resistant closing elements of the functional voids provided in the bulkheads (from outside) located at the inner corners of production and storage structures in the form of **L, T** or **U**, the values set out in Table 13 shall be used.

2) In the case of full height glazing, the solution in the previous paragraph may be chosen (glazed areas of at least height **1.20 m**) which must meet the criteria set out above (in point (b))



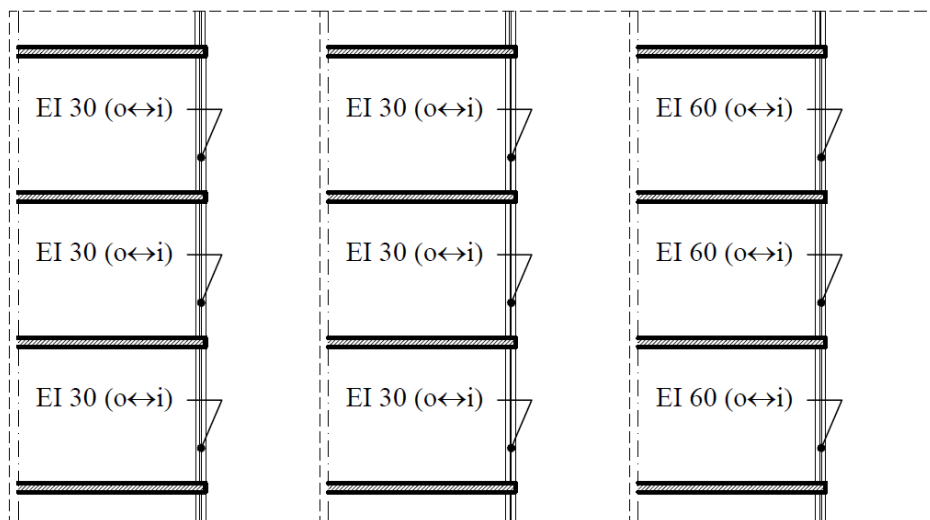
EI 30 (o → i) etanșare EI 30	EI 30 (o ↔ i) sealing IE30
------------------------------	----------------------------

a) in buildings of normal height

b) in high buildings

c) in very high buildings

**Variant 1): General case – performance of continuous glazed areas in the plane of the curtain wall**



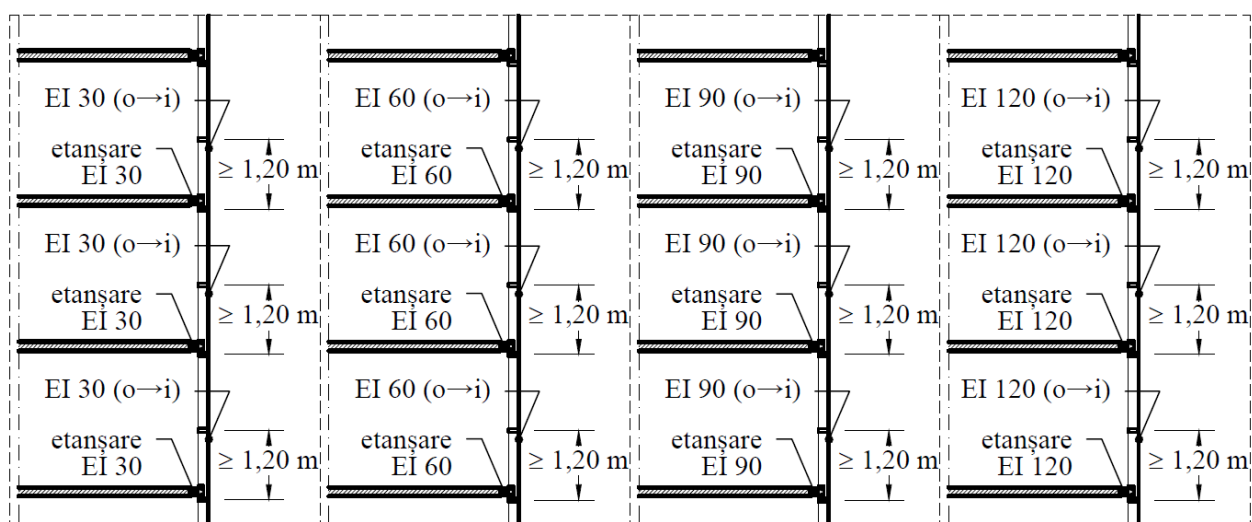
a) in buildings of normal height

b) in high buildings

c) in very high buildings



**Variant 2): General case – continuous-glazed areas performance in joinery**



EI 30 (o → i) etansare EI 30	EI 30 (o ↔ i) sealing IE30
------------------------------	----------------------------

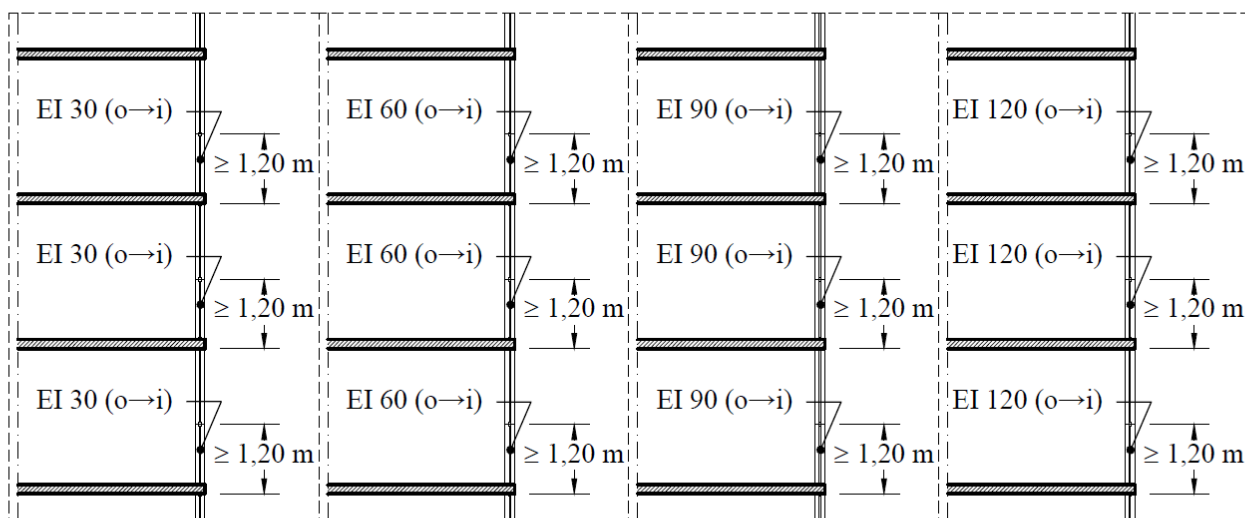
a) in buildings of normal height

b) in high buildings

c) in very high buildings below the height of 125 m:

d) in very high buildings with a height greater than or equal to 125 m

**Variant 3): Performance of glazed areas of at least 1.20 m height arranged in the plane of the curtain wall**



a) in buildings of normal height

b) in high buildings

c) in very high buildings below the height of 125 m:

d) in very high buildings with a height greater than or equal to 125 m

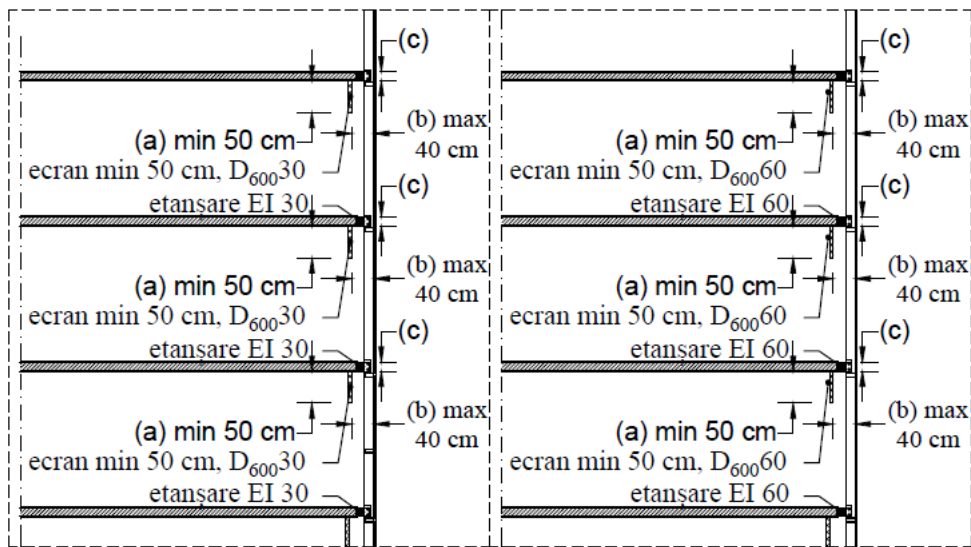
**Variant 4): Glazed area performance with a height of at least 1.20 m in joinery**

**Figure 46 - Full-height glazed curtain wall or joinery performance**

d. protective screens (Figure 47) must meet the following criteria:

- in buildings of normal height:
  - i. height of at least **50 cm**, placed under the supporting floor in such a way as to comply with H + L solutions **≥ 1.20 m** (and)
  - ii. minimum fire resistance **D<sub>600</sub>30**;
- in high buildings:
  - i. height of at least **1.20 m**, placed under the supporting floor so as to comply with H + L solutions **≥ 1.20 m** (and)

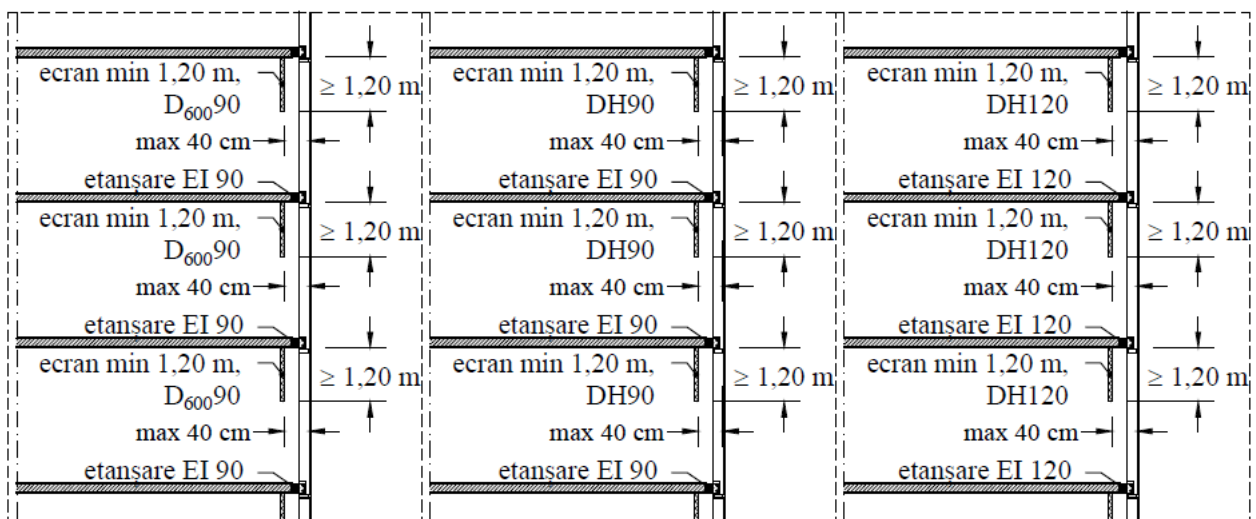
- ii. minimum fire resistance **D<sub>600</sub>60**;
- in very high buildings below the height of **75 m**:
  - i. height of at least **1.20 m**, placed under the supporting floor, (and)
  - ii. minimum fire resistance **D<sub>600</sub>90**;
- in very high buildings with a height greater than or equal to **75 m** and less than **125 m**:
  - i. height of at least **1.20 m**, placed under the supporting floor, (and)
  - ii. minimum fire resistance **DH90**;
- in very high buildings with a height greater than or equal to **125 m**:
  - i. height of at least **1.20 m**, placed under the supporting floor, (and)
  - iii. minimum fire resistance **DH120**;



(a) min 50 cm	(a) min. 50 cm
ecran min 50 cm. D <sub>600</sub> 30	screen min. 50 cm. D <sub>600</sub> 30
etanşare EI 301	sealing EI 301

**a) in buildings of normal height**  $H + L \geq 1.20 \text{ m}$  ( $a + b + c \geq 1.20 \text{ m}$ )

**b) in high buildings**  $H + L \geq 1.20 \text{ m}$  ( $a + b + c \geq 1.20 \text{ m}$ )



ecran min 1,20 m	screen min. 1.20 m
D <sub>600</sub> 90	D <sub>600</sub> 90

max 40 cm	max 40 cm
etanşare EI 90	sealing EI 90

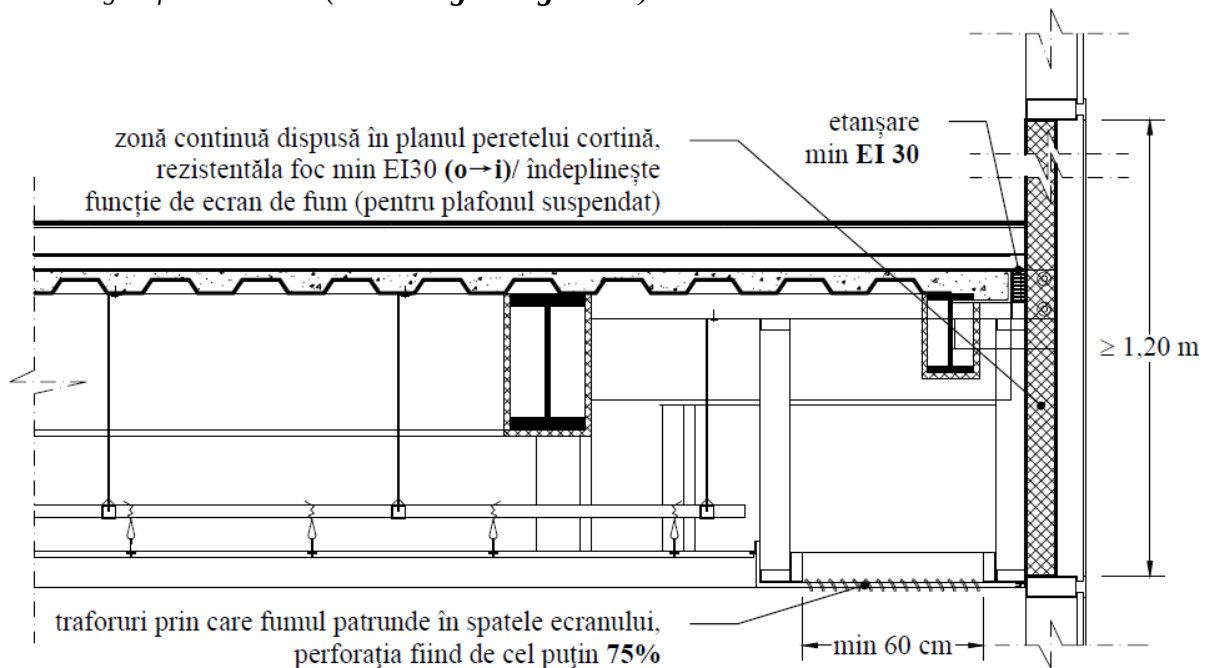
**a) in very high buildings below the height of 75 m (screen  $D_{600}90 \geq 1.20$  m)**

**b) in very high buildings of height greater than or equal to 75 m and less than 125 m (screen  $DH90 \geq 1.20$  m)**

**c) in very high buildings of 125 m or more in height (screen  $DH90 \geq 1.20$  m)**

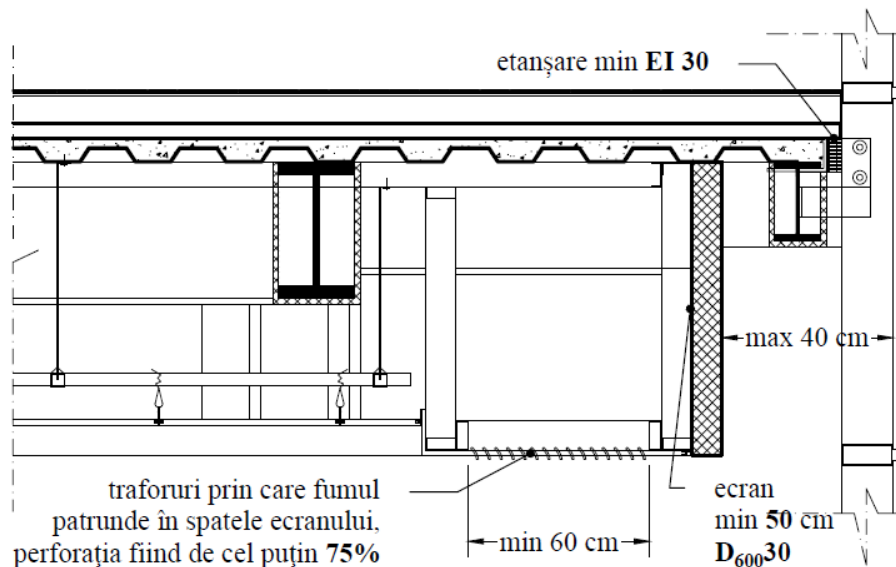
**Figure 47 - Protective screens performance**

**Note:** When the suspended or self-supporting ceilings are placed at the lower end of the screens or continuous areas in the plane of the curtain wall to count on the efficiency of the screens, free spots (triforia) shall be provided in the ceilings where the smoke enters the rear of the screen, the perforation being at least 75 % of the area of the perforated area of the roof. The perforated area shall have at least 60 cm depth over the entire length of the outer wall (according to Figure 48).



zonă continuă dispusă în planul peretelui cortină, rezistentă la foc min EI30 (o → i) îndeplinește funcție de ecran de fum (pentru plafonul suspendat)	continuous area placed in the plane of the curtain wall, fire-resistant min. EI30 (o → i) performs smoke screen function (for suspended ceiling)
etanşare min EI 30	sealing min. EI 30
traforuri prin care fumul pătrunde în spatele ecranului, perforația fiind de cel puțin 75%	triforia in which the smoke enters the rear of the screen, the perforation being at least 75 %
min 60 cm	min. 60 cm

**Variant a) with a continuous area arranged in the plane of the curtain wall**



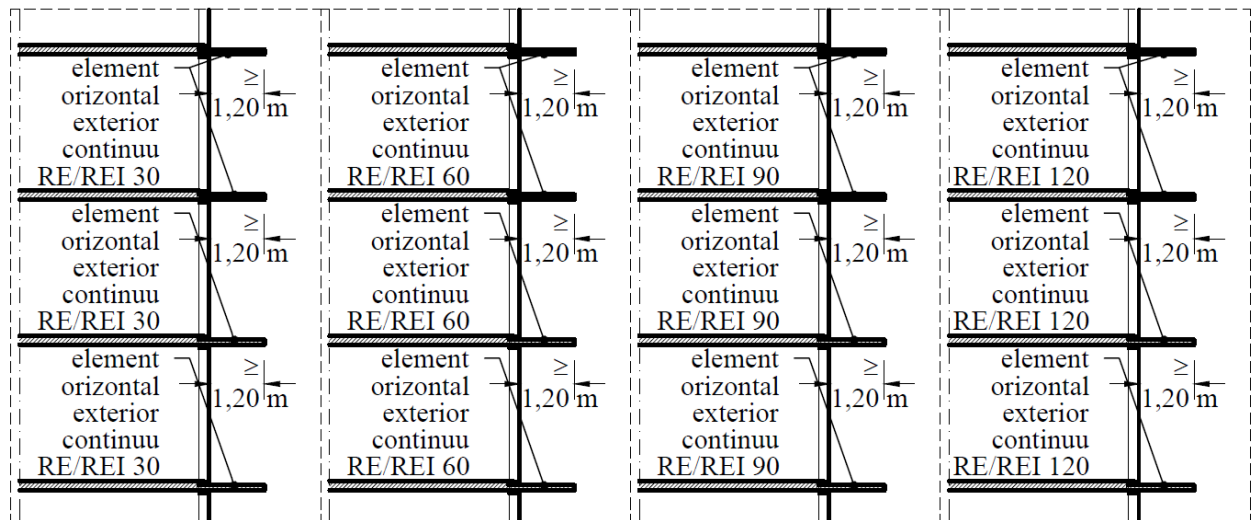
etanșare min <b>EI 30</b>	sealing min. <b>EI 30</b>
traforuri prin care fumul pătrunde în spatele ecranului, perforația fiind de cel puțin 75%	triforia in which the smoke enters the rear of the screen, the perforation being at least 75 %
min 60 cm	min. 60 cm
max 40 cm	max. 40 cm
ecran min 50 cm <b>D<sub>600-30</sub></b>	min. screen 50 cm <b>D<sub>600-30</sub></b>

*Variant b) with screen*

**Figure 48 - Non-combustible fretted elements at ceilings**

(2) Continuous horizontal external elements (attached to the building floors or a continuation thereof as defined in Figure 49) resistant to fire (**RE** if they are non-trafficable or **REI** if trafficable) must meet the following criteria:

- in buildings of normal height:
  - i. width (measured horizontally) of at least **1.20 m** (and)
  - ii. minimum fire resistance **RE 30** or **REI 30**;
- in high buildings:
  - i. width (measured horizontally) of at least **1.20 m** (and)
  - ii. minimum fire resistance **RE 60** or **REI 60**;
- in very high buildings below the height of **125 m**:
  - i. width (measured horizontally) of at least **1.20 m** (and)
  - ii. minimum fire resistance **RE 90** or **REI 90**;
- in very high buildings with a height greater than or equal to **125 m**:
  - i. width (measured horizontally) of at least **1.20 m** (and)
  - ii. minimum fire resistance **RE 120** or **REI 120**.



element	element
orizontal	horizontal
exterior	exterior
continuu	continuous
RE/REI 30	RE/REI 30

a) in buildings of normal height

b) in high buildings

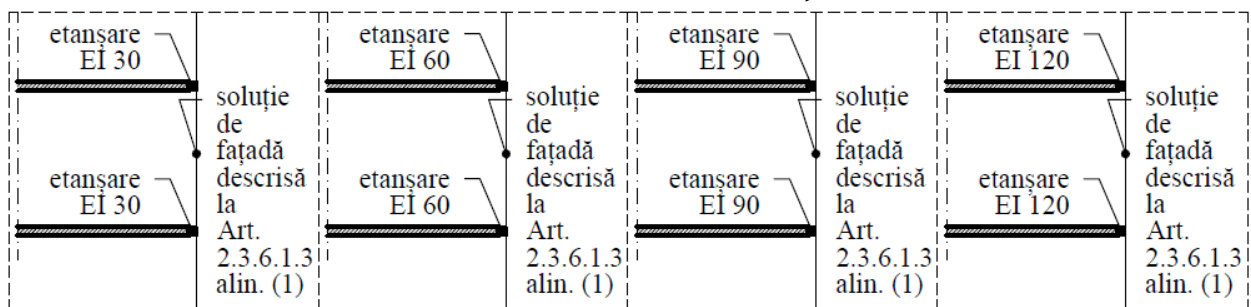
c) in very high buildings below the height of 125 m:

d) in very high buildings with a height greater than or equal to 125 m

**Figure 49 - Performance of continuous horizontal external fire resistant elements**

(3) For the delay of fire propagation through the interior of the construction, gaps between the floor and the curtain bulkhead shall be sealed by sealing systems with the same fire-resistant floor (Figure 50), as follows:

- in buildings of normal height:
  - i. minimum fire resistance **EI 30**;
- in high buildings:
  - i. minimum fire resistance **EI 60**;
- in very high buildings below the height of **125 m**:
  - i. minimum fire resistance **EI 90**;
- in very high buildings with a height greater than or equal to **125 m**:
  - i. minimum fire resistance **EI 120**;



etansare EI 30	sealing EI 30
Soluție de fațadă descrisă la Art. 2.3.6.1.31 alin. (1)	Façade solution described in Article 2.3.6.1.31 (1)

a) in buildings of normal height

b) in high buildings

c) in very high buildings below the height of 125 m:

d) in very high buildings with a height greater than or equal to 125 m

**Figure 50 - Sealing performance of gaps between floor and curtain wall**

**Article 2.3.6.1.4. (1)** For delaying fire propagation in buildings that are not high and/or very high, between building levels outside the perimeter closure (on the façade) and through the interior of the constructions of:

– buildings:

- with crowded rooms,
- intended for persons who cannot evacuate themselves,
- with temporary accommodation operation,
- pre-primary, primary and secondary education

with height  $h < 8 \text{ m}$  (where ‘ $h$ ’ represents the elevation of the last useable building floor compared to the reference level)

and

– buildings with functions other than those listed above with a rise  $> P + 2E$  and  $\leq P + 5E$  or with height  $8 \leq h < 20 \text{ m}$  (where ‘ $h$ ’ represents the elevation of the last usable building floor compared to the reference level), excluding condominiums (collective and semi-segregated dwellings) and individual dwellings,

one of the following measures may be adopted:

a. external walls (non-load-bearing) and/or parts of external fire resistant walls classified from outside to the inside (**o** → **i**) between which glazed elements without fire performance are interleaved, the following criteria shall be met:

i. height of at least **1.20 m** (measured vertically according to the rule **H + L**)

(and)

ii. minimum fire resistance **EI 30 (o → i)**;

b. continuous areas in the plane of the curtain wall shall meet the following criteria:

i. height of at least **1.20 m** (measured vertically according to the rule **H + L**)

(and)

ii. minimum fire resistance **EI 30 (o → i)**;

c. curtain wall or joinery panel shall meet the following criterion:

i. minimum fire resistance **EI 30 (o → i)**;

d. protective screens shall meet the following criteria:

i. height of at least **50 cm**, placed under the supporting floor in such a way as to comply with the solutions **H + L** at least **90 cm**

(and)

ii. minimum fire resistance **D<sub>600</sub>30**;

e. continuous horizontal external elements shall meet the following criteria:

i. width of at least **1.20 m** (measured horizontally according to rule **H + L**)

(and)

ii. minimum fire resistance **RE** or **REI 30**;

Gaps between the floor and the curtain bulkhead shall be sealed by sealing systems with the same fire-resistance as the floor, depending on the level of fire stability of the construction, but not less than **EI 30**.

**Article 2.3.6.1.5.** To delay the propagation of fires between building levels outside the perimeter closure (on the facade) and through the interior of the constructions of:

– buildings:

- with any function, except those with crowded rooms, with persons who cannot evacuate themselves, temporary accommodation, pre-primary, primary and secondary education and condominiums (collective and semi-molecular housing) and individual dwellings

with height  $h < 8 \text{ m}$  (where 'h' represents the elevation of the last useable building floor compared to the reference level)

and

– condominium consisting of one or more constructions, some of which are common properties and the rest are individual properties, where applicable, with rise  $> P + 2E$  and  $< P + 5E$  or with height  $8 \leq h < 20 \text{ m}$  (where 'h' represents the elevation of the last usable building floor compared to the reference level), excluding condominiums and individual dwellings,

one of the following measures may be adopted:

a. external walls (non-load-bearing) and/or parts of external fire resistant walls classified from outside to the inside (**o** → **i**) between which glazed elements without fire performance are interleaved, the following criteria shall be met:

i. height of at least **90 cm** (measured vertically according to the rule **H + L**)

(or)

i. height of at least **90 cm** (measured vertically in diagonal direction in the shortest direction)

(and)

ii. minimum fire resistance **EI 30 (o → i)**;

b. continuous areas in the plane of the curtain wall shall meet the following criteria:

i. height of at least **90 cm** (measured vertically according to the rule **H + L**)

(and)

ii. minimum fire resistance **EI 30 (o → i)**;

c. curtain wall or joinery panel shall meet the following criterion:

i. minimum fire resistance **EI 30 (o → i)**;

d. protective screens shall meet the following criteria:

i. height of at least **50 cm**, placed under the supporting floor

(and)

ii. minimum fire resistance **D<sub>600</sub>30**;

e. the continuous horizontal external elements shall meet the following criteria:

i. width (measured horizontally according to rule **H + L**) at least **90 cm**

(and)

ii. minimum fire resistance **RE** or **REI 15**;

Gaps between the floor and the curtain bulkhead shall be sealed by sealing systems with the same fire-resistance as the floor, depending on the level of fire stability of the construction, but not less than **EI30**.

**Article 2.3.6.1.6.** To delay the propagation of fires between building levels outside perimeter closure (on the facade) and inside the condominium of one or more constructions, some of which are common properties and the rest are individual properties with height  $h < 8 \text{ m}$  (where 'h' represents the elevation of the last useable building floor compared to the reference level), with the exception of individual dwellings, to delay the spread of fires outside the perimeter closure (on the facades), one of the following measures may be taken:

a. Differences between display cases in external walls (non-load bearing) shall meet the following criteria:

i. height of at least **50 cm** (measured vertically according to the rule **H + L**)

(and)

ii. height at least **90 cm** (measured vertically in diagonal direction in the shortest direction according to the rule **H + L**)

b. Continuous external horizontal elements shall be at least fire-resistant **R15** over the width of at least **50 cm** (measured horizontally according to rule **H + L**).

Gaps between the floor and the curtain bulkhead shall be sealed by sealing systems with the same fire-resistance as the floor, depending on the level of fire stability of the construction, but not less than **EI30**.

**Article 2.3.6.1.7.** To delay the propagation of fires between building levels outside the perimeter closure (on the façade) and through the interior of residential buildings representing individual units (single family, service, intervention, need for support, protocol, holiday homes) or a condominium consisting of dwellings and constructions for other purposes, individual, isolated, strung or coupled, in which the individual properties are interdependent by a forced and perpetual common property, with the height of  $h = \text{maximum } 8 \text{ m}$  (where ‘**h**’ represents the elevation of the last useable building floor compared to the reference level) no binding measures are foreseen.

**Article 2.3.6.1.8.** In constructions with fire-resistant perimeter closures, the external thermal insulation and/or external thermal insulation composite systems (compact systems in end-use conditions) of perimeter walls shall be the reaction to fire class as set out in Table 16.

**Table 16: External thermal insulation and/or composite thermal insulation systems (compact systems in end use) on facades filled or fitted with unprotected glazed elements or other gaps (for different functions/types of buildings)**

<b>Functions</b>	<b>Number of maximum allowable levels/total height (up to the coping of the roof)</b>	<b>Thermal insulation/thermal insulation composite system</b>
<b>Dwellings</b>	Single family dwellings max. $P + E$ or $P + M$	minimum <b>D-s3,d0</b>
	Multi-dwelling blocks $\leq P + 2E$ (or $\leq 10 \text{ m}$ total height to the coping of the roof/attic) <sup>1)2)</sup>	minimum <b>C-s3,d0</b>
	Multi-dwelling blocks $> P + 2E$ and $< P + 5E$ (up to 20 m total height (up to the coping of the roof/attic) <sup>1)2)</sup> )	minimum <b>B- s3,d0</b>
	Multi-dwelling blocks $\geq P + 5E$ (6 levels) and with less than 20 m total height (up to the coping of the roof/attic)	minimum <b>B- s2,d0</b>
	Multi-dwelling blocks with more than 20 m total height (up to the coping of the roof/attic) and $\leq P + 11E$ <sup>1)2)</sup>	<b>A1 or A2-s1,d0</b>
	Residential blocks $> P + 11E$ (high or very high)	<b>A1 or A2-s1,d0</b>
<b>Administrative</b>	Buildings $\leq P + 2E$ <sup>2)</sup>	minimum <b>C- s3,d0</b>
	Buildings $> P + 2E$ and $\leq P + 5E$ or Buildings up to 20 m total height (up to the coping of the roof/attic) <sup>1)2)</sup>	minimum <b>B- s3,d0</b>
	$> P+5E$ or Buildings with a total height of more than 20 m (up to the coping of the roof/attic) <sup>1)2)3)</sup>	minimum <b>B- s2,d0</b>
	High or very high buildings	<b>A1 or A2-s1,d0</b>
<b>Trade</b>	Buildings $\leq P + 1E$ or Buildings up to 8 m high to the last level of calming or up to 10 m total height (up to the coping of the roof/attic) <sup>1)</sup>	minimum <b>C- s2,d0</b>
	Buildings $> P + 1E$ and $\leq P + 5E$ <sup>2)</sup> or	minimum <b>B- s2,d0</b>



<b>Functions</b>	<b>Number of maximum allowable levels/total height (up to the coping of the roof)</b>	<b>Thermal insulation/thermal insulation composite system</b>
	Buildings up to 20 m total height (up to the coping of the roof/attic) <sup>1)</sup>	
	Buildings > P + 5E <sup>2)</sup> or Buildings with a total height of more than 20 m (up to the coping of the roof/attic) <sup>1) 2)</sup>	minimum <b>B- s1,d0</b>
	High or very high buildings	<b>A1 or A2-s1d0</b>
	Shopping centres	<b>A1 or A2-s1d0</b>
	Buildings ≤ P + 3E <sup>2)</sup>	<b>A1 or A2-s1d0</b>
	Buildings > P + 3E and ≤ P + 5E <sup>2)</sup> or Buildings up to 20 m total height (up to the coping of the roof/attic) <sup>1) 2)</sup>	<b>A1 or A2-s1d0</b>
<b>Health</b>	> P + 5E <sup>2)</sup> or Buildings with a total height of more than 20 m (up to the coping of the roof/attic) <sup>1) 2)</sup>	<b>A1 or A2-s1d0</b>
	High or very high buildings	<b>A1 or A2-s1d0</b>
	Buildings ≤ P + E	minimum <b>C s2, d0</b>
	Buildings ≥ P + 2E <sup>2)</sup> and ≤ P + 5E <sup>2)</sup> and Buildings up to 20 m total height (up to the coping of the roof/attic) <sup>1)</sup>	minimum <b>B s1,d0</b>
<b>Culture</b>	Buildings > P + 5E <sup>1) 2)</sup> or Buildings with a total height of more than 20 m (up to the coping of the roof/attic) <sup>1) 2)</sup>	minimum <b>B s1,d0</b>
	High or very high buildings	<b>A1 or A2-s1d0</b>
	Buildings housing particular values (heritage)	<b>A1 or A2-s1d0</b>
	Buildings for pre-primary, primary and secondary education buildings	minimum <b>B s1,d0</b>
	Buildings for tertiary, non-university and university education buildings	minimum <b>B s1,d0</b>
	Buildings for P + E for pre-primary, primary and secondary education	<b>A1 or A2-s1d0</b>
	Buildings P + E for tertiary, non-university and university education	minimum <b>B s1,d0</b>
	Buildings ≥ P + 2E (or ≤ 8 m) and ≤ P + 5E <sup>2)</sup> and Buildings up to 20 m total height (up to the coping of the roof/attic) <sup>1)</sup>	<b>A1 or A2-s1d0</b>
	Buildings > P + 5E <sup>2)</sup> or Buildings with a total height of more than 20 m (up to the coping of the roof/attic) <sup>1) 2)</sup>	<b>A1 or A2-s1d0</b>
	High or very high buildings	<b>A1 or A2-s1d0</b>
<b>Tourism</b>	Alpine lodge P + E + M	minimum <b>B- s3,d0</b>
	Buildings ≤ P + 2E and ≤ 100 persons	minimum

<b>Functions</b>	<b>Number of maximum allowable levels/total height (up to the coping of the roof)</b>	<b>Thermal insulation/thermal insulation composite system</b>
		<b>B-s1,d0</b>
	Buildings $\leq P + 4E^{2)}$ or > 100 people and without crowded rooms <sup>2)</sup>	minimum <b>B-s1,d0</b>
	Buildings $> P + 4E$ and Buildings up to 20 m total height (up to the coping of the roof/attic) <sup>1)2)</sup>	<b>A1 or A2-s1d0</b>
	Buildings $\leq P + 4E^{2)}$ or Buildings with a total height of more than 20 m (up to the coping of the roof/attic) <sup>1)2)</sup>	<b>A1 or A2-s1d0</b>
	High or very high buildings	<b>A1 or A2-s1d0</b>
<b>Cult</b>	Buildings $\leq P + E$	minimum <b>C s2, d0</b>
	Buildings $> P + 2E$ and Buildings up to 20 m total height (up to the coping of the roof/attic) <sup>1)</sup>	minimum <b>B s1,d0</b>
	$> P + 5E^{2)}$ Or more than 20 m total height (up to the coping of the roof/attic) <sup>1)2)3)</sup>	minimum <b>B s1,d0</b>
	High or very high buildings	<b>A1 or A2-s1d0</b>
	Buildings housing particular values (heritage)	<b>A<sub>1</sub> or A<sub>2</sub> s1,d0</b>
<b>Sports</b>	Buildings $\leq P + E$	minimum <b>C s2, d0</b>
	Buildings $\geq P + 2E$ (or $\leq 8$ m) and up to 20 m total height (up to the coping of the roof/attic) <sup>1)</sup>	minimum <b>B s1,d0</b>
	Buildings $\leq P + 5E^{2)}$ or Buildings with a total height of more than 20 m ((up to the coping of the roof/attic) <sup>1)2)</sup>	minimum <b>B s1,d0</b>
	High or very high buildings	<b>A1 or A2-s1d0</b>
<b>Buildings/fire compartments with crowded rooms</b>	Amalgamated (with other crowded rooms)	<b>A1 or A2-s1d0</b>
	Independent	<b>A1 or A2-s1d0</b>
<b>Other functions</b>	Buildings $\leq P + 2E^{2)}$	minimum <b>C- s3,d0</b>
	Buildings $> P + 2E$ and $\leq P + 5E$ or Buildings up to 20 m total height (up to the coping of the roof/attic) <sup>1)2)</sup>	minimum <b>B- s3,d0</b>
	$> P+5E$ or Buildings with a total height of more than 20 m (up to the coping of the roof/attic) <sup>1)2)3)</sup>	minimum <b>B- s2,d0</b>
	High or very high buildings	<b>A1 or A2-s1,d0</b>

Notes:

<sup>1)</sup>- measured in relation to the adjacent accessible road terrain, where this is possible on more than one facade.

<sup>2)</sup> - it does not refer to high or very high buildings

– in cases where the designed construction will fall within the maximum permissible above-ground levels specified in the table but the fire stability level is higher, then composite thermal insulation systems of the full facade corresponding to the fire stability level shall be chosen, but these shall not be taken into account when determining the level of fire stability.

– external thermal insulation and/or composite external thermal insulation systems shall be fitted according to the manufacturers' recommendations

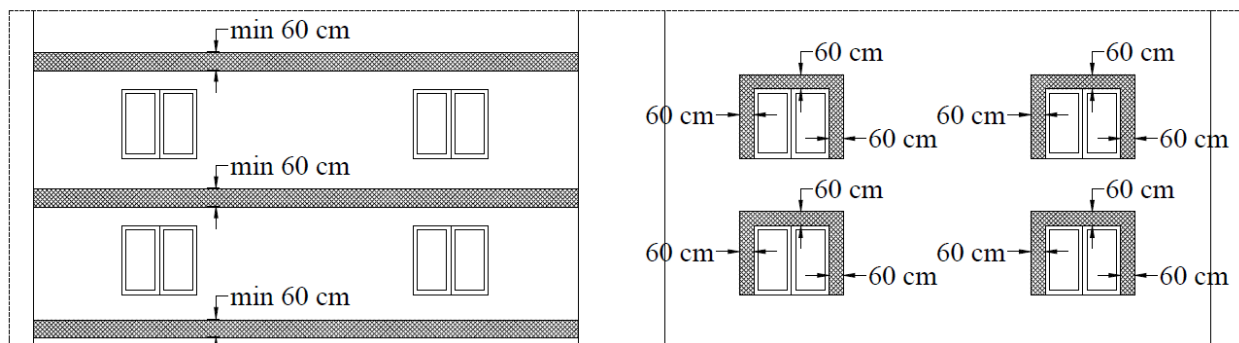
<sup>3)</sup> for mixed-function buildings, criteria for the most severe reaction to fire class shall be adopted.

**Article 2.3.6.1.9. (1)** Where in the construction works referred to in **Article 2.3.6.1.8.**, the composite external thermal insulation systems for perimeter walls are different from **A1, A2-s1d0**, for the solution designed for thermal insulation of the facades indicated in the preceding article, windows and doors of perimeter closures shall be bordered on the outer side and top sides with thermal insulation the reaction to fire class **A1** or **A2-s1d0** of a width of not less than **60 cm** when using non-combustible joinery and wood joinery (*Figure 51, variant a2*) and the outer side and top sides are bordered with thermal insulation class reaction to fire **A1** or **A2-s1d0** of a width of not less than **60 cm** and the lower side, with thermal insulation, reaction to fire class **A1** or **A2-s1d0** of a width of not less than **30 cm** when using combustible joinery (except wood) (*Figure 51, variant b2*). In both variants, the bordering must be of the same thickness as the thermal insulating material of the facade, according to **Annex** on 'Limiting fire propagation on the façade'.

**(2)** Bordering of gaps in perimeter closures referred to in **par. 1** may be replaced by:

**a)** continuous horizontal heat-insulation strips in class reaction to fire **A1** or **A2-s1d0** located next to all the floors of the building, having a minimum width **60 cm** and same thickness as the material used for external thermal insulation of the perimeter closure (*Figure 51, variant; A1) or B1)*)

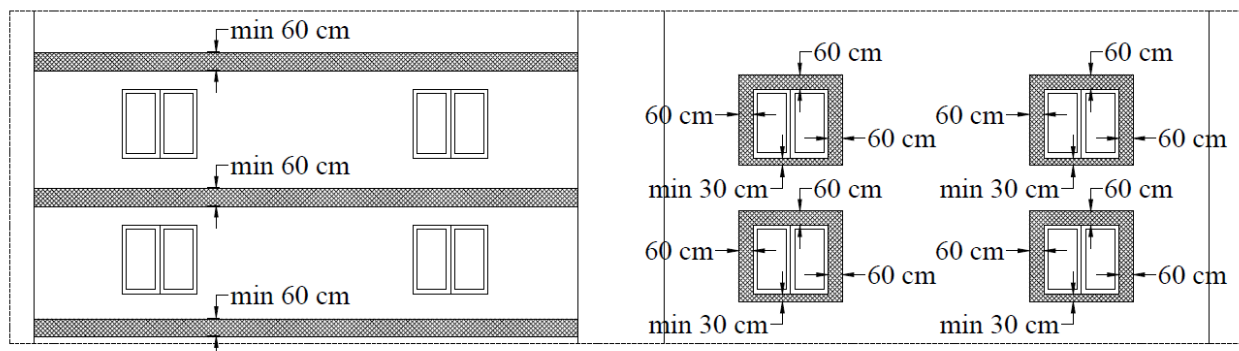
**b)** continuous outdoor curves of a width of at least **60 cm** (measured horizontally), reaction to fire class **A1** or **A2-s1d0**. These horizontal elements must exceed the voids with minimum **60 cm** and in horizontal projection.



**a1) alternative to gaps bordering**

**a2) gaps bordering**

**Variant a) Non-combustible or wooden joinery**



min 60 cm
-----------

min. 60 cm
------------

**b1) alternative to gaps bordering**

**b2) gaps bordering**

**Variant b) Combustible carpentry, except wood**

**Figure 51 - Gaps bordering in perimeter closures**

**Article 2.3.6.1.10.** Products used for external finishing (including thermal insulation or outer covering) of perimeter closures of high or very high buildings shall be the reaction to fire class **A1** or **A2-s1d0**.

**Article 2.3.6.1.11.** The heat insulation and finish of the facade shall comply with the standard fire reaction classes.

**2.3.6.2. General provisions on limiting the spread of fire on the roof**

**Article 2.3.6.2.1. (1)** Products used to insulate the terrace of high and very high buildings must be the reaction to fire class **A1** or **A2-s1d0**.

**(2)** In buildings that are not high and very high and have a height greater than **20 m** (measured in the coping of the roof or attic) from the adjacent terrain or road accessible to fire-fighter intervention vehicles, the materials used to insulate terrace roofs may be the minimum reaction to fire class **B-s3d0**. When photovoltaic panels are located over these roofs, the final layer of the coatings must comply with the provisions of **Table 2 reference No 10 point (b)** or Table 3 reference No 10 point (b).

**(3)** The reaction class to fire of thermal insulation material used for heat-insulation of terrace roofs may be minimum **C-s3d0** for other categories of buildings with a height regime of less than **20 m** (measured in the coping of the roof or attic) from the adjacent terrain or road accessible to fire-fighter intervention vehicles. When photovoltaic panels are located over these roofs, the final layer of the coatings must comply with the provisions of **Table 2, reference No 10 point (b)** or **Table 3 reference No 10 point (b)**.

**(4)** By way of exception from the provisions of **par. 1, 2 and 3**, the use of combustible thermal insulation materials without fire performance is permitted:

a) where thermal insulation is positioned between the reinforced concrete floor and an equalisation layer or slope concrete of minimum **3.00 cm**, and mineral wool class is used on all crossings required for the installations and on the whole contour of the terrace in reaction to fire class **A1, A2 s1, d0** over a minimum width of **50 cm**;

b) in the situation of thermal insulation positioning between the equalisation layer and a poorly reinforced screw with thickness of **5 cm**.

**2.3.6.3. Limiting the development of fire effluents (smoke, hot gases)**

**Article 2.3.6.3.1.** In order to limit the development of fire effluents (smoke, hot gases) and the slight spread of fire within the construction, as appropriate, appropriate protective systems shall be provided, namely:

a) systems for achieving differential overpressure (according to **SR EN 12101-13** –Smoke and heat control systems. Part 13: Pressure differential systems (PDS). Design and calculation methods, installation, acceptance testing, routine testing and maintenance, and **SR EN 12101-6** –Smoke and heat control systems. Part 6: Specification for pressure differential systems. Kits);

b) smoke and hot gas exhaust systems, made according to the provisions of the Rule;

c) smoke and hot gas exhaust systems, made according to standards: **SR CEN/TR 12101-5** – Smoke and hot gas control systems. Part 5: Functional guidance and calculation methods for smoke and hot gas exhaust systems

## SECTION IV

### 2.4. Constructive compositions

#### 2.4.1. General provisions

**Article 2.4.1.1.** (1) Buildings, fire compartments and their building elements shall be constructed and conform in such a way as not to facilitate the easy spread of fire and smoke inside and outside them.

(2) In constructions with a level **I** of fire stability, the heat load density resulting from the materials and building elements used shall not exceed **275 MJ/m<sup>2</sup>**, with the exception of floor coverings on support in class reaction to fire **A1** or **A2-s1d0** and fire-resistant compliant to criteria **REI** according to the provisions of **Table 2 reference No 3** (for floors). Floorings may be mounted directly or on a sound-insulating layer to impact (vibration damping) having the reaction to fire class **A1** or **A2-s1d0**.

**Article 2.4.1.2.** (1) Where permitted, combustible materials, products and building elements (which are not of reaction to fire classes **A1** or **A2-s1d0**) used in construction, it is recommended not to have internal gaps. If they have internal gaps, they must be interrupted to the maximum extent **4 m** vertically and not more than **6 m** horizontally.

(2) Interruptions of internal voids may be made of the same materials of the construction element and voids in vertical building elements shall not communicate with voids in horizontal building elements.

(3) Interrupting the continuity of gaps in horizontal building elements is also mandatory in front of fire resistant partitions as well as at the compaction-expansion joints. Vertical gaps shall be interrupted against the floors.

(4) Interruption of the continuity of internal voids is also mandatory for combustible wall and floor cladding, but does not concern ventilation/conditioning ducts and spaces for ventilation/conditioning above the suspended ceilings as well as building attics.

(5) The interruption of the continuity of facade-associated internal voids incorporate in ventilation shall comply according to **NP 135**.

#### 2.4.2. Stairways

**Article 2.4.2.1.** (1) Vertical paths (stairways, ramps) provided for normal functional and escape movement in the event of fire by the construction users shall meet the standard conditions of layout, composition, dimensioning and fire resistance, according to the provisions of the Rule.

(2) Vertical paths shall conform to fires occurring outside them. Fires may occur inside the building or on the facades of the building.

**Article 2.4.2.2.** (1) The separation walls of enclosed staircases for the functional and escape paths for users from the rest of the construction in civil buildings shall comply with the provisions on the performance specific to the use and type of such buildings. Separation walls from adjacent storage rooms shall also meet the conditions specific to those fire hazards, whichever is greater.

(2) The separation walls of enclosed staircases for the functional and escape paths for users from the rest of the construction in high, very high civil buildings or with crowded rooms and in other situations laid down in the Rule shall comply with their specific conditions.

(3) In production and storage buildings, the walls separating the enclosed staircases from functional and escape paths for users from the rest of the building shall also meet the specific conditions of the respective risks of fire and/or volumetric explosion in the adjacent rooms.

**Article 2.4.2.3.** The composition of walls behind recesses or slots in the separation walls of enclosed staircases from the rest of the construction shall ensure at least the following fire resistances:

- a) **EI/REI 90**, in buildings with fire stability level **I**;
- b) **EI/REI 60**, in buildings with fire stability level **II**;
- c) **EI/REI 45**, in buildings with fire stability level **III**;
- d) **EI/REI 15**, in buildings with fire stability level **IV** or **V**.

**Article 2.4.2.4.** Floor coverings separating staircases and their outdoor exit routes at the level of the land or road adjacent to the rest of the construction shall comply with the provisions concerning the performance specific to the use and type of such buildings and the requirements to ensure the level of fire stability of the construction.

**Article 2.4.2.5. (1)** The floors, beams and ramps of users' internal (closed or open) stairway, with the exception of those specified in the Rule for work platforms, shall be as a minimum:

- a) **R 90 and** reaction class to fire **A1** or **A2-s1d0**, in constructions with fire stability level **I**;
- b) **R 60 and** reaction class to fire **A1** or **A2-s1d0**, in constructions with fire stability level **II**;
- c) **R 45** and reaction to fire class **A1** or **A2-s1d0**, in constructions with fire stability level **III**;
- d) **R 30** and class of reaction to fire minimum **B-s1d0**, in constructions with fire stability level **IV**;
- e) **R 15 and** reaction to fire class minimum **D-s1d0**, in constructions with fire stability level **V** (where permitted).

(2) For internal stairways that ensure the escape of maximum of 2 successive levels, criterion R shall not apply to steps, risers and landing places.

**Article 2.4.2.6.** Floors, beams and ramps of functional open internal stairways which do not constitute escape routes for users shall be at least:

- a) **R 90** in constructions with fire stability level **I**;
- b) **R 60** in constructions with fire stability level **II**;
- c) **R 45** in constructions with fire stability level **III**;
- d) **R 30** in constructions with fire stability level **IV**;
- e) not classified with fire stability level **V** (where permitted).

**Article 2.4.2.7. (1)** The functional and escape movement gaps for users in the stairway separation walls enclosures from the rest of the construction shall be protected by closing elements constructed and carried out according to the standardised provisions, for each fire risk of buildings, type, operation and destination.

(2) Gaps through which users of civil buildings have access to enclosed staircases shall be protected according to the provisions on performance specific to the use and type of such buildings.

(3) Gaps in which users of production and/or storage buildings have access to enclosed staircases shall be protected according to the performance provisions specific to these functions.

**Article 2.4.2.8. (1)** In order to prevent smoke entering escape routes and spread of fires from one level to another, stairways, whether or not they are taken into account in the evacuation, shall be separated from the rest of the building by walls and floors formed according to this Rule. If not enclosed in staircases, they shall be prevented on the contour of the floor with continuous fire

resistant screens with minimum **DH 60** for the level **I** and **II** of fire stability and minimum **DH 30** for other levels of fire stability, with a minimum height **50 cm** (below the floor) and sprinklers, over the entire length of the screens, with the installation's normal operating time of minimum **60** minutes, provided that the building is equipped with this type of extinguishing installation.

(2) Stairways may be opened (not enclosed in staircases) if they ensure the escape of not more than two successive above-ground levels of the construction, under the conditions laid down by the Rule.

(3) Are exempt from the provisions laid down in **par. 1** monumental open stairways, intermediate levels, mezzanines, loams, balconies and other situations explained in the Rule, as well as paths perpendicular to graduations. Specific measures shall be provided for them depending on the number of users, the destination or the type of building at their disposal. In production and/or storage buildings, users' access to machines, tools, walkways, open platforms, intermediate levels, etc., which are not permanent places of work, shall be carried out according to their specific measures.

### **2.4.3. Horizontal common paths**

**Article 2.4.3.1. (1)** Common horizontal operational and escape paths of building users (corridors, halls, protected openings, escape tunnels, etc.) shall be separated from the rest of the building corresponding to the purpose and density of the heat load (**q**), according to the provisions laid down therein.

(2) Common horizontal escape paths shall conform to fires occurring outside them.

**Article 2.4.3.2. (1)** Walls and floors separating common horizontal functional and escape paths from civil buildings from the rest of the construction shall comply with the performance provisions specific to the purpose and type of these buildings. Walls and separation floors of horizontal common paths from storage rooms shall also meet the conditions specific to those fire risks, adopting the highest value.

(2) The separation walls from the rest of the construction of common horizontal functional and escape paths from high, very high and civil buildings with crowded rooms and in other situations laid down in the Rule shall comply with their specific conditions.

(3) In production and/or storage buildings, the walls separating functional and escape horizontal common paths for users from the rest of the building shall also meet the conditions specific to the respective risks of fire and/or volumetric explosion in the adjacent rooms.

(4) When making separations in open spaces (working - for administrative function or other type according to function), for activities that require frequent communication or in open spaces with the same fire risk and destination (own or complementary) of the open space type, the following requirements must be taken into consideration:

- a)** partition panels shall be made of fire class materials **A1** or **A2-s1d0**, except in the case of non-substantial components, glazing elements (of glass) simply or insulating and glazing fittings; the partitioning panels shall ensure a minimum glazed area of **50 %** from their area on the side on which the door is located. The glazing on the side where the door is located shall be located above the lower third of the partition panels, aiming to ensure visibility in the eye area of users. Over glazing on the side on which the door is placed, it is prohibited to apply sheets to obscure or to place such items of furniture;
- b)** partition panels shall not influence the operation of fire protection installations;
- c)** horizontal common paths resulting from the separations shall be provided with smoke and hot gas exhaust systems in the event of fire, with automatic opening controlled by the centre of detection, signalling

and fire warning, if there are no direct windows with moving meshes outwards to evacuate smoke in the event of fire;

**d)** the length of the escape path shall be calculated from the furthest point (maximum **40** cm from the wall) of open space spaces to the entrance to the nearest protected space (protected buffer room, protected clearance, escape stairway, etc.) or outside, and shall be the maximum value set by the Rule for **2** directions, when they are necessary, having regard to separation panels and fixed furniture; in the case of open stairways, the escape length shall be measured up to their first step; a minimum of two distinct and independent escape routes shall be provided for open spaces;

**e)** the finishes of open type spaces shall meet the requirements laid down for horizontal exhaust paths.

**f)** cross-beams, panels and internal partitions, of a reaction to fire class **A1** or **A2-s1d0** within groupings of spaces (working – for administrative or other function as required by operation), for activities requiring frequent open space communication or spaces with the same fire and destination risk (own or complementary), the maximum standard surface may be used in relation to any level of fire stability;

**g)** cross-beams and/or panels of combustible materials specified in **Article 2.1.3.4 point (i)** may be used in relation to fire stability levels as follows:

– minimum reaction to fire class **D-s2d0** or whose finishes meet the minimum fire performance criteria **K<sub>2</sub> 10** (at level **IV** and **V** of fire stability);

– minimum reaction to fire class **C-s2d0** or whose finishes meet the minimum fire performance criteria **K<sub>2</sub> 30** (at level **III** of fire stability);

– minimum reaction to fire class **B-s1d0** or whose finishes meet the minimum fire performance criteria **K<sub>2</sub> 60** (at level **II** of fire stability).

– not admissible (on level **I** of fire stability).

**Article 2.4.3.3. (1)** The gaps for functional movement and escape of users, practiced in the walls separating the common horizontal paths from the rest of the construction, shall be protected with closing elements composed and made according to the provisions of the Rule.

**(2)** Movement gaps arranged in the horizontal common circulation separation walls in civil buildings shall be protected according to the provisions on performance specific to the use and type of such buildings.

**(3)** Movement gaps arranged in horizontal common paths separating walls in production and/or storage construction shall be adequately protected to the specific fire risks of adjacent rooms.

**Article 2.4.3.4. (1)** Protected clearance and escape tunnels shall be of a maximum length of **200 m** and must be separated from the rest of the construction with **elements in class A1** or **A2-s1d0** fire resistant to heat load densities of adjacent rooms, through fire resistant walls (**EI/REI**), fire resistant floors (**REI**) according to the fire stability level of the construction and fire resistant doors **EI-C5S<sub>200</sub>**, not less than:

**a)** walls **EI/REI 120** and doors **EI<sub>2</sub>60-C5S<sub>200</sub>**, in constructions with fire stability level **I**;

**b)** walls **EI/REI 90** and doors **EI<sub>2</sub>45-C5S<sub>200</sub>**, in constructions with fire stability level **II**;

**c)** walls **EI/REI 60** and doors **EI<sub>2</sub>30-C5S<sub>200</sub>** in constructions with fire stability level **III**;



- d) walls **EI/REI 45 and** doors **EI<sub>20</sub>-C5S<sub>200</sub>** in constructions with fire stability level **IV**;
- e) walls **EI/REI 30 and** doors **EI<sub>15</sub>-C5S<sub>200</sub>** in constructions with fire stability level **V**.

(2) Where protected clearances are parking points for persons with disabilities, they must be separated from the rest of the component construction with elements in class **A1** or **A2-s1d0** fire resistant to heat load densities of adjacent rooms, through fire resistant walls (**EI/REI**), fire resistant floors (**REI**) according to the fire stability level of the construction and fire resistant doors **EI-C5S<sub>200</sub>**, not less than:

- a) walls **EI/REI 120 and** doors **EI<sub>60</sub>-C5S<sub>200</sub>**, in constructions with fire stability level **I**;
- b) walls **EI/REI 180** and doors **EI<sub>90</sub>-C5S<sub>200</sub>**, in constructions with fire stability level **II** not fitted with automatic extinguishing system and walls **EI/REI 120 and** doors **EI<sub>60</sub>-C5S<sub>200</sub>**, in constructions with fire stability level **II** which are equipped with an automatic extinguishing system;
- c) walls **EI/REI 90 and** doors **EI<sub>45</sub>-C5S<sub>200</sub>** in constructions with fire stability level **III** not fitted with automatic extinguishing system and walls **EI/REI 60 and** doors **EI<sub>30</sub>-C5S<sub>200</sub>**, in constructions with fire stability level **III** which are equipped with an automatic extinguishing system;
- d) walls **EI/REI 60 and** door **EI<sub>30</sub>-C5S<sub>200</sub>** in constructions with fire stability level **IV** (walls **EI/REI 60 and** doors **EI<sub>30</sub>-C5S<sub>200</sub>** in pre-school education buildings with the fire stability level **IV**);
- e) walls **EI/REI 30 and** doors **EI<sub>15</sub>-C5S<sub>200</sub>** in constructions with fire stability level **V**;

(3) Density of heat load of rooms adjacent to protected clearances and tunnels may result in a change in the fire resistance performance of the preceding paragraphs, provided that they are not less than those referred to in paragraph 1 and 2.

(4) Doors from the walls of protected clearances and tunnels to rooms shall be fire-resistant according to standardised provisions and according to the provisions laid down in such a way that they do not obstruct the escape of persons.

(5) Protected clearances and escape tunnels shall be fitted with systems for the exhaust of smoke and hot gases in the event of fire (or with excess pressure) between **20 ÷ 80 Pa** depending on the specific of construction).

(6) Protected clearances and (protected) escape tunnels shall not be taken into account in the calculation of the length of the escape path.

## **2.4.4. Lifts**

### **2.4.4.1. General provisions**

**Article 2.4.4.1.1.** Lifts intended for the functional movement of persons, goods, elevators, monte-charge units and intervention lifts shall be carried out according to the provisions of the Rule and legislation laying down the conditions for the placing on the market of lifts.

**Article 2.4.4.1.2. (1)** Lifts and in general vertical transport systems in constructions, including the rooms for their machinery, shall be separated from the rest of the building by fire resistant walls (**EI** as appropriate **REI**) and fire resistant floors (**REI**), corresponding to the level of stability, the fire risk, the density of the heat load ( $q$ ) in adjacent rooms, the type of building and its destination, according to the provisions of the Rule.

(2) Lifts intended for the functional movement of persons, lifts contained in above-ground or underground staircases, those located in atriums, as well as access to platforms, galleries or passageways open to the rest of the construction, may be unseparated with fire-resistant elements.

(3) The location of material lifts or any other vertical transport system of materials shall not be permitted in enclosed staircases intended for the functional movement and escape of civil, production and/or storage users.

**Article 2.4.4.1.3.** Lift shafts, protection of access voids and lifts intended for functional movement, as well as fire intervention lifts (fire brigade) and for the transport of disabled persons (as well as those which may also be used for their assisted escape in the event of fire), shall comply with the specific performance requirements laid down in the Rule and in specific technical regulations.

**Article 2.4.4.1.4.** Lifts intended for the functional movement of persons, goods, intervention in the event of fire (fire brigade) and for the transport of patients with stretchers or wheelchairs or persons with disabilities, as well as elevators, must be designed, constructed, installed and operated according to the applicable legislation.

#### **2.4.4.2. Lifts for the functional movement of persons, goods and other vertical material transport systems**

**Article 2.4.4.2.1. (1)** Lift shafts intended for the functional movement of persons and generally for vertical transport systems shall be separated from the rest of the construction by vertical elements and, where appropriate, horizontal elements, in reaction to fire class **A1** or **A2-s1d0** and fire resistant corresponding to the level of fire stability provided, building type and destination, but minimum:

- a) fire resistant walls **EI/REI 120** and where applicable, floors of minimum **REI 90**, in constructions with fire stability level **I**;
- b) fire resistant walls **EI/REI 90** and where applicable, floors of minimum **REI 60**, in constructions with fire stability level **II**;
- c) fire resistant walls **EI/REI 60** and where applicable, floors of minimum **REI 45**, in constructions with fire stability level **III**;
- d) fire resistant walls **EI/REI 45** and where applicable, floors of minimum **REI 30**, in constructions with fire stability level **IV**;
- e) fire resistant walls **EI 30** and where applicable, floors of minimum **REI 15**, in constructions with fire stability level **V** (where permitted).

(2) In high and very high buildings and in specific functions, the performance requirements for separating shafts for lifts from the rest of the construction shall be complied with.

(3) Lift station doors intended for the functional movement of persons and generally for vertical transport systems starting in open space (where they are permitted) shall have the performance characteristics of the doors according to **Article 2.4.4.2.5.** for lifts station doors intended for the functional movement of persons and **paragraph 7** for the station doors of small material lifts (monte-charge type), electric or hydraulic. Specific provisions shall be complied with in high, very high buildings and in buildings with crowded rooms.

(4) If at least one lift station and generally vertical transport systems start in spaces not protected by smoke (except halls or corridors with fire resistant walls, protected clearances/tunnels, etc.) which have higher performance characteristics of room doors or higher performance characteristics of walls (generated by function or heat load density), lifts shall comply (at least at that level, as the case may be) in accordance with those conditions.

(5) As an alternative solution, in situations where it is not necessary to ensure the exhaust of smoke and hot gases in the event of fire of the space where the doors referred to in paragraphs **3** and **4** start (according to the standard provisions), a lock chamber may be provided (at the entrance of the passenger lift) whose door to these spaces transfers the performance characteristics described in paragraphs **3** and **4**. Where it is necessary to ensure the exhaust of smoke and hot gases in the event of fire of the space in which the doors referred to in paragraphs **3** and **4** start (according to the standard provisions), a protected buffer room shall be provided.

(6) Small electrical or hydraulic monte-charge lifts shall be separated by walls and floors, as appropriate, fire resistant according to **paragraph 1**.

(7) Access gaps to small electrical or hydraulic (monte-charge) lifts that start in halls/corridors shall be protected as a minimum:

- a) in constructions with fire stability level **I**;
  - fire resistant landing doors **EI 60**;
- b) in constructions with fire stability level **II**;
  - fire resistant landing doors **EI 45**;
- c) in constructions with fire stability level **III**;
  - fire resistant landing doors (lifts) in minimum class **EI 30**;
- d) in constructions with fire stability level **IV**;
  - fire resistant landing doors **EI 20**;
- e) in constructions with fire stability level **V** (where the Rule allows);
  - fire resistant landing doors **EI 15**;

(8) If at least one station starts in a space requiring doors with higher fire resistance performance characteristics (generated by operation or thermal load density), the gaps of access to small (monte-charge), electrical or hydraulic lifts shall comply (at least on that level, as appropriate) with doors according to those conditions.

(9) If small (monte-charge type) electrical or hydraulic lifts have a two-access cab, all specified gaps shall meet the conditions of **paragraph 7**.

(10) Panoramic lifts are exempted from the provisions of paragraph 1. Sliding doors of panoramic lifts, mounted on the facades of buildings shall be fire-tight **E 30** and measures shall be taken to prevent the spread of fire on the façade.

(11) Lifts halls for the functional movement of persons in public buildings can communicate freely with level public spaces.

**Article 2.4.4.2.2. (1)** Rooms in which equipment for hydraulic or electrical lifts is located shall be separated from the rest of the construction by vertical and, where appropriate, horizontal elements equal to the fire performance of the floors according to the stability level the reaction to fire class **A1** or **A2-s1d0** corresponding to the level of fire stability provided, building type and destination, but minimum fire-resistant walls **EI/REI 120** and minimum floors **REI 60** and the door for communication with the rest of the construction shall be minimum **EI, 60-C3**, with opening outwards.

(2) The rooms in which equipment for intervention lifts is located shall be separated from the rest of the construction by vertical and, where appropriate, horizontal elements equal to the fire performance of walls and doors corresponding to the specific requirements of the above-ground part of the building and the floor of the intervention lifts, according to the types or functions of the building, the reaction to fire class **A1** or **A2-s1d0** corresponding to the level of fire stability provided.

**Article 2.4.4.2.3. (1)** Maximum three (3) mechanical vertical means of transport (lifts intended for the functional movement of persons, cargo, monte-charge, lifting platforms, etc.) of the same type, with the exception of lifts intended for intervention in the event of fire (fire brigade) and those in very high buildings, may be provided in a lift shaft.

(2) It is recommended that lifts corresponding to the above-ground construction levels should be arranged in separate shafts from those of the underground levels.

(3) The location of cargo and charge lifts is not permitted in escape staircases. They shall only be placed in their own independent shafts, separated from the rest of the construction according to the provisions of the Rule.

**Article 2.4.4.2.4. (1)** The separation walls from the rest of the construction of cargo lifts shall be at least:

- a) **IA/REI 180** reaction class to fire **A1** or **A2-s1d0** for the level **I** of fire stability;
- b) **EI/REI 120** reaction class to fire **A1** or **A2-s1d0** for the level **II** of fire stability;
- c) **EI/REI 60** reaction class to fire **A1** or **A2-s1d0** for the level **III** of fire stability;
- d) **EI/REI 45** reaction class to fire **B-s1d0** for the level **IV** of fire stability;
- e) **EI/REI 30** reaction class to fire min. **B-s2d0** for the level **V** of fire stability.

(2) In civil, production and/or storage buildings, empty access to cargo lifts shall be protected by sealed or fire resistant doors according to the standard provisions.

**Article 2.4.4.2.5. (1)** Gaps of access to lifts intended for the functional movement of persons (non-disabled or disabled) shall be protected as a minimum by fire resistant doors (lifts):

- a) **EI 60** in constructions with fire stability level **I**;
- b) **EI 45** in constructions with fire stability level **II**;
- c) **EI 30** in constructions with fire stability level **III**;
- d) **EI 20** in constructions with fire stability level **IV**;
- e) **EI 15** in constructions with fire stability level **V** (where the norm allows);

(2) Where gaps of access to lifts intended for the functional movement of persons (non-disabled or disabled) start in smoke free spaces (staircases equipped with excess pressure or smoke discharge, protected buffer rooms, protected releases, protected halls with air inlet and smoke exhaust or overpressure, or protected corridors with mechanical intake of air and smoke discharge or overpressure), it is not necessary to provide fire resistance performance to the access gaps referred to in paragraph 1.

(3) Specific provisions shall be complied with in high, very high and buildings with crowded rooms.

### ***2.4.4.3. Lifts for the transport of disabled persons***

**Article 2.4.4.3.1. (1)** Lift shafts intended for the functional movement of disabled persons shall be separated from the rest of the construction by vertical and, where appropriate, horizontal elements, according to **Article 2.4.4.2.1 paragraph 1**.

(2) Gaps of access to lifts provided for the functional movement of persons with disabilities shall be protected according to **Articles 2.4.4.2.5 paragraph 1 and 2.4.4.2.1 paragraphs 2, 3, 4 and 5**.

**Article 2.4.4.3.2.** Lifts for the transport of persons by wheelchairs or disabled persons which may also be used for their assisted escape in the event of fire shall be provided for in the cases laid down in the Rule and specific technical regulations.

**Article 2.4.4.3.3.** Lifts for the transport of persons by wheelchairs or disabled persons which may also be used for their assisted escape in the event of fire shall be additionally provided, where parking points for disabled persons are not provided in staircases or protected buffer rooms or protected escape rooms or protected corridors, on each level of the building with a view to their subsequent rescue by qualified persons.

### ***2.4.4.4. Fire response lifts (fire brigade)***

**Article 2.4.4.4.1.** Fire response lifts (fire brigade) are mandatory in the situations set out in the Rule and shall be made out according to the provisions on specific performance.

**Article 2.4.4.4.2.** Fire response lifts (fire brigade) may be additionally foreseen at the request of the beneficiaries, as well as when additional fire safety measures are to be taken in construction.

## **2.4.5. Self-supporting or suspended ceilings and raised floors**

**Article 2.4.5.1. (1)** Combustible self-supporting or suspended ceilings (with a continuous closed surface) and combustible raised floors (where permitted), shall have interrupted continuity at the perimeter of the room’s fire resistant walls, including the boundary of opaque functional or delineation glazed panels, as well as at the side of the construction works.

**(2)** Interruption of continuity shall be carried out with continuous strips of materials of the reaction to fire class **A1** or **A2-s1d0** with width of at least (one) **1 m** arranged in the plane of the suspended roof or of raised floors or through clearances with width of at least (one) **1 m** arranged in the plan of the suspended ceiling.

**Article 2.4.5.2. 1.** In the case of full suspended ceilings (with the closed continuous area), the continuity of the void between the ceiling and the floor is interrupted by continuous diaphragms made of materials of the reaction to fire class materials **A1** or **A2-s1d0** arranged at a maximum distance of **30 m** in two perpendicular directions when the space between the suspended roof and the supporting floor is not equipped with an automatic sprinkler extinguishing system. In all cases, account shall be taken of the provisions of **Article 8.1.2**. The crossing of the diaphragms by the construction installations shall be carried out by providing seals with non-combustible elements without required fire resistance.

**(2)** Interruption of the continuity of the gap between the ceiling and the floor is not mandatory at ceilings with open or modular surface removable, perforated, lamellar, honeycomb or grill (non-full suspended ceilings), ventilation/conditioning channels and building attics, as well as in the case of protection of the space between the ceiling and floor with automatic sprinkler extinguishing systems.

**(3)** Continuous or discontinuous/modular surface ceilings of the perforated, lamellar, comb or grill type (both full and non-full) shall be made of materials classified in the reaction to fire class **A1** or **A2-s1d0**. Materials classified in a different reaction to fire class (as set out in Table 17) shall also be permitted in rooms which are not situated in high and very high buildings, do not constitute spaces or rooms with crowded persons, and are separated from the rest of the construction with fire-resistant walls according to the level of stability.

**Table 17: Classes of reaction to fire performance of ceiling materials**

<b>Fire stability level</b>	<b>Ceilings</b>		
	<b>corridors and halls</b>	<b>in enclosed staircases</b>	<b>Rooms</b>
<b>I</b>	<b>A1, A2-s1d0</b>	<b>A1, A2-s1d0</b>	<b>min B-s1d0</b>
<b>II</b>	<b>A1, A2-s1d0</b>	<b>A1, A2-s1d0</b>	<b>min B-s2d0</b>
<b>III</b>	<b>min B-s1d0</b>	<b>A1, A2-s1d0</b>	<b>min B-s3d0</b>
<b>IV</b>	<b>min C-s1d0</b>	<b>min B-s1d0</b>	<b>min C-s3d0</b>
<b>V</b>	<b>min D-s1d0</b>	<b>min C-s1d0</b>	<b>min d0</b>

**Article 2.4.5.3.** Electrical appliances, lighting fixtures and, in general, heating sources must be mounted against the combustible finishes provided for the walls, ceilings and floors, either at the standard distances, or with the protection measures established in the applicable standards.

**Article 2.4.5.4. (1)** Raised floor coverings shall be made of construction products according to the standard provisions.

(2) On the common, functional and escape movement paths of the users of different spaces or functions of the buildings, as well as in the rooms, the fire resistance of the raised floor is established according to the level of stability to fire.

(3) In the common, functional and escape movement paths of users of the various buildings' spaces or functions, and in other rooms, spaces or functions of the constructions, the raised floor must have the fire reaction class established according to the provisions of **Table 18**. Finishes mounted above raised floor coverings shall have the reaction to fire class similar to that provided for the floor coverings as specified in **Table 18**.

(4) The continuity of the void between the raised floor and the floor on which it is placed shall be interrupted by continuous diaphragms made of materials of the reaction to fire class materials **A1** or **A2-s1d0** arranged at a maximum distance of **30** m in two perpendicular directions when the room in which it is located is not equipped with an automatic sprinkler extinguishing system. The crossing of the diaphragms by the construction installations shall be done with the assurance of tightness with non-combustible elements without imposed fire resistance.

**Table 18: Classes of reaction to fire performance of products used for raised floorings**

Fire stability level	Raised floorings		Rooms in buildings with H > 75 m
	in corridors and halls	Rooms	
<b>I</b>	<b>A1<sub>FL</sub>, A2<sub>FL</sub>-s1</b>	<b>min B<sub>FL</sub>-s1</b>	<b>A2<sub>FL</sub>-s1</b>
<b>II</b>	<b>A1<sub>FL</sub>, A2<sub>FL</sub>-s1</b>	<b>min C<sub>FL</sub>-s1</b>	-
<b>III</b>	<b>min B<sub>FL</sub>-s1</b>	<b>min C<sub>FL</sub>-s1</b>	-
<b>IV</b>	<b>min C<sub>FL</sub>-s1</b>	<b>min D<sub>FL</sub>-s1</b>	-
<b>V</b>	-	-	-

- (4) The fire resistance of raised floors shall be:
- a) **REI 60** for the level **I** of fire stability;
  - b) **REI 30** for the level **II** of fire stability;
  - c) **RE 30** for the level **III** of fire stability;
  - d) **RE 30-r** for the level **IV** of fire stability.

#### 2.4.6. Finishes

**Article 2.4.6.1. (1)** Finishes on the common functional and escape routes for users of buildings of normal height, when they are not made of decorative glass with no mirror effect, shall be made of materials of the reaction to fire class **A1** or **A2-s1d0**, respectively **A1** or **A2<sub>FL</sub>-s1**, , for level **I** and **II** of fire stability, minimum **B-s1d0**, respectively **B<sub>FL</sub>-s1** for fire stability level **III**, minimum **C-s1d0**, respectively **C<sub>FL</sub>-s1** for the level **IV** of fire stability and minimum **D-s1d0**, respectively **D<sub>FL</sub>-s1** for the level **V** of fire stability, as set out in Table 19, with the exceptions provided for in the Rule

(2) On the common horizontal paths of functional circulation and evacuation of users of constructions with normal height, as well as in rooms, foil finishes with a maximum thickness of 5 mm that are glued to **A1** or **A2-s1d0** support and carpets or wood, with a thickness of maximum 20 mm, minimum **C<sub>FL</sub>-s1**, mounted directly or on a soundproofing layer for impact noise, which are glued or placed freely on **A1** or **A2-s1d0** support. The noise insulation layer at impact/vibration damping layer shall have at least the same class of reaction to fire with the finish referred to in paragraph 1.

**Table 19: Classes of reaction to fire performance of products used for interior finishes in enclosed staircases, horizontal escape routes (corridors and halls, tunnels, protected clearance, etc.) and rooms in above-ground buildings**

Fire stability level	Finishes					
	in corridors and halls		in enclosed staircases		in rooms	
	Walls	Floorings	Walls	Floorings	Walls	Floorings
<b>I</b>	<b>A1, A2-s1d0</b>	<b>A1<sub>FL</sub>, A2<sub>FL</sub>-s1</b>	<b>A1, A2-s1d0</b>	<b>A1<sub>FL</sub>, A2<sub>FL</sub>-s1</b>	<b>min. B-s1d0</b>	<b>min. B<sub>FL</sub>-s1</b>
<b>II</b>	<b>A1, A2-s1d0</b>	<b>A1<sub>FL</sub>, A2<sub>FL</sub>-s1</b>	<b>A1, A2-s1d0</b>	<b>A1<sub>FL</sub>, A2<sub>FL</sub>-s1</b>	<b>min. B-s2d0</b>	<b>min. C<sub>FL</sub>-s1</b>
<b>III</b>	<b>min. B-s1d0</b>	<b>min. B<sub>FL</sub>-s1</b>	<b>A1, A2-s1d0</b>	<b>min. B<sub>FL</sub>-s1</b>	<b>min. B-s3d0</b>	<b>min. C<sub>FL</sub>-s1</b>
<b>IV</b>	<b>min. C-s1d0</b>	<b>min. C<sub>FL</sub>-s1</b>	<b>min. B-s1d0</b>	<b>min. C<sub>FL</sub>-s1</b>	<b>min. C-s3d0</b>	<b>min. D<sub>FL</sub>-s1</b>
<b>V</b>	<b>min. D-s1d0</b>	<b>min. D<sub>FL</sub>-s1</b>	<b>min. C-s1d0</b>	<b>min. D<sub>FL</sub>-s1</b>	-	-

**Article 2.4.6.2 1.** Finishes, treatment and thermal and sound-insulation, internal combustible for use in construction shall not create gaps (cavities) with a depth greater than **30 cm** to the support elements to which they are applied (walls or floors).

(2) Gaps between the supporting elements and combustible heat and/or sound treatments shall have interrupted continuity according to the provisions of **Article 2.4.1.2.**

**Article 2.4.6.3.** Internal finishes, treatment and insulation, thermal and sound-insulation, used in rooms with an agglomeration of persons and in any room in buildings where there are more than **50** users, regardless of the area of a person's floor area and in rooms with health functions, shall have the minimum reaction class to fire **C-s1d0**, respectively **C<sub>FL</sub>-s1**, in compliance with the conditions set out in Table 19.

**Article 2.4.6.4.** The classes of reaction to fire performance of products used for the interior finishing of enclosed staircases and of common functional and horizontal escape routes (corridors and halls) in above-ground buildings shall correspond to the common performance requirements and to those specific to the use and type of buildings.

**Article 2.4.6.5.** As a rule, in spaces with a risk associated with the type of users (accessible to preschool children and those in primary and secondary education, rooms where they sleep, those used by people who cannot evacuate themselves, etc.), it is allowed to use constructions elements, materials, finishes, carpentry panels, treatments and thermal and sound insulation fire reaction class **A1, A2-s1,d0** or **B-s1,d0**, including metal or wooden carpentry panels (doors, windows) with glass glazing, with the exceptions provided in the Rule.

## **2.4.7. Provisions for constructive compositions specific to limiting the spread of fire on the facade**

### **2.4.7.1. Curtain walls**

**Article 2.4.7.1.1.** Curtain walls, for use in perimeter closures of buildings, shall be made of profiles (frames or uprights and beams) with the reaction to fire class **A1** or **A-2s1d0** with the exception of non-substantial components, gaskets, insulators and glazing elements (of glass) only or insulating, the anchoring to their building structure shall also be made of the elements of the reaction to fire class **A1** or **A-2s1d0** except for non-substantial components. Panel filling panels, when used in curtain walls, shall be made of materials of the reaction to fire class **A1** or **A-2s1d0** except for non-substantial components.

**Article 2.4.7.1.2.** Curtain walls shall be designed, composed and constructed in such a way as to delay the spread of fires from one level to another, both outside the construction (on the front) and through the interior of the construction.

**Article 2.4.7.1.3.** In order to limit the spread of fire on facades, the provisions of **Article 2.3.6.1.2 must be complied with.** ÷ **Article 2.3.6.1.7.**

**Article 2.4.7.1.4.** In order to limit the spread of fire on the facades of high and very high buildings, specific performance provisions must be observed.

#### **2.4.7.2. *Ventilated facades***

**Article 2.4.7.2.1.** Ventilated façades must comply with the provisions of the specific legislation and technical regulation, without taking into account the substitution of the continuous area **E30** (or more, according to standard provisions) with a screen.

**Article 2.4.7.2.2.** When the ventilated façade is made on a fire resistant bulkhead separating the fire compartments (fire bulkhead), it shall have a standard fire resistance and the ventilated facade system shall be such that it does not favour the propagation of fire.

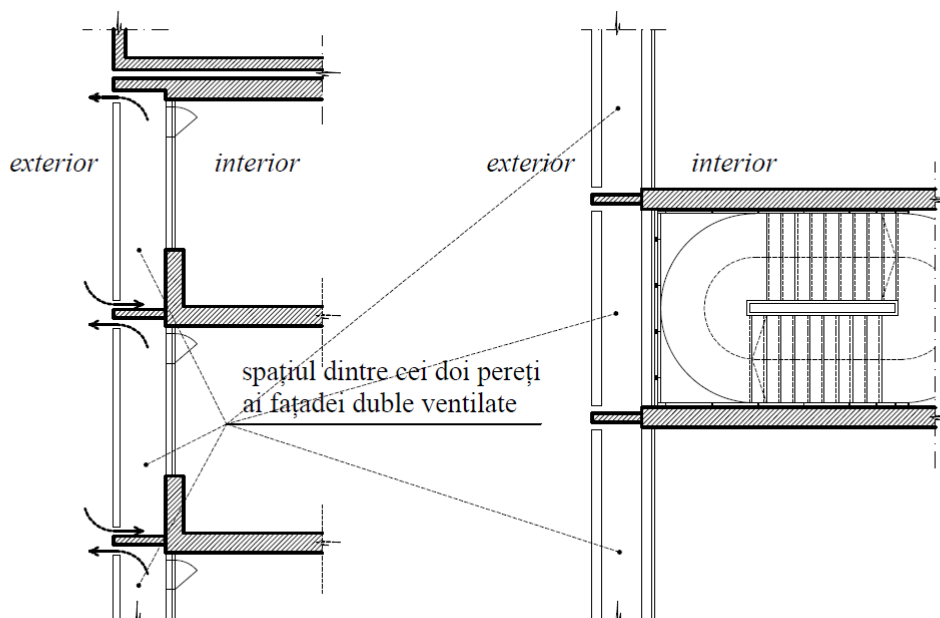
**Article 2.4.7.2.3.** Ventilated façades shall have interrupted continuity at least on the compaction, expansion or seismic joints of construction works. Interruption of continuity shall be achieved through non-ventilated wall areas of at least one **(1) m** width or with non-combustible diaphragms.

#### **2.4.7.3. *Double façades – double skin***

**Article 2.4.7.3.1.** Double façades – double skin shall be used in perimeter closures of buildings with fire stability level **I** to **III** and shall be made with profiles (frames and/or uprights and beams) of the reaction to fire class **A1** or **A2-s1d0**, except in the case of non-substantial components, gaskets, insulators and glazing (glass) elements, the anchoring of the double-facade strength structure – ‘double skin’ shall be made with elements of the reaction class to fire **A1** or **A2-s1d0**, except for non-substantial components. Panel filling panels, when used in the double skin facade, shall be made of materials with the reaction to fire class **A1** or **A-2s1d0**, except for non-substantial components.

**Article 2.4.7.3.2.** A double facade system is considered satisfactory from the point of view of fire safety, when the inner wall of the double facade complies with the rules of the simple facade with curtain walls, and the outer wall is made in such a way as to cancel the chimney effect, by providing horizontal and/or vertical separations, , according to Table 20 (*example Figure 52*)





<i>exterior</i>	<i>exterior</i>
<i>interior</i>	<i>interior</i>
spațiul dintre cei doi pereți fațadei duble ventilate	space between the two walls of the double ventilated facade

*section*  
**Horizontal separation of floors**

*plane*  
**Vertical separation of floors**

**Figure 52 - Cancellation of the double-façade stack effect**

**Article 2.4.7.3.3. (1)** For buildings of normal height (double façade system – double skin, if the conditions laid down in Art. 2.4.7.3.2. are not fulfilled, then the inner wall of the double façade – double skin shall comply with the following condition: minimum **EW30** throughout the full height of the construction;

**1.1.** In buildings of normal height, when using perimeter closures with double facades, gaps between the floor and the inner envelope of the double facade, when fitted, shall be sealed with systems having the same fire resistance as the floor, but not less than **EI 30**.

**(2)** In high buildings, if the conditions laid down in **Article 2.4.7.3.2.** are not fulfilled, then the inner wall of the double façade – double skin shall comply with the following condition: minimum **EI 30** throughout the full height of the construction;

**2.1.** In high buildings, when using double facade perimeter closures, gaps between the floors and the inner envelope of the double facade, when fitted, shall be sealed with systems having the same fire resistance as the floor, but minimum **EI 90**.

**(3)** In very high buildings (double façade system – ‘double skin’, if the conditions set out in **Article 2.4.7.3.2.** are not fulfilled, then the inner wall of the double facade shall comply with the following condition: minimum **EI 60** throughout the full height of the construction, except for windows which must be **EI 30**;

**3.1.** In very high buildings, when using perimeter closures with double facades, gaps between the floor and the inner envelope of the double facade, when fitted, shall seal with systems having the same fire resistance as the floor, but minimum **EI 90** for constructions of height **h < 75m** and minimum **EI 120** for very high constructions with a height **h ≥ 75m**;

**(4)** When using perimeter closures with double façades in very high heights with the height **h ≥ 75 m**, they shall be continuously divided horizontally from at least each **10 in 10** floors.

**Article 2.4.7.3.4.** Alternative to the provisions of **Article 2.4.7.3.2.** and of the **Article 2.4.7.3.3.**, the space between the two walls of the ventilated double façade may be equipped at each level with

automatically and manually operated water curtain with a minimum duration of operation **60 minutes** and a system for the exhaust of smoke and hot gases in the event of fire, taking the necessary measures to protect these installations from frost and weather. In this situation, the inner wall shall only meet the fire resistance conditions specific to single facades with curtain walls, depending on the type of building.

**Table 20: Horizontal and vertical separation in a double façade system**

No	Number of floors/building height	Horizontal and vertical separation of floors/rooms Minimum class of fire resistance of partitions	Vertical separation of stairways Minimum class of fire resistance of vertical partitions
1.	Less than five floors, without automatic fire extinguishing system	<b>EW 30</b>	<b>EW 30</b>
2.	Five or more floors up to 28 m high without automatic fire extinguishing system	<b>EW 60</b>	<b>EI 60</b>
3.	Five or more floors up to 28 m high equipped with automatic fire-fighting system	<b>EI 30</b>	<b>EI 30</b>
4.	High buildings without automatic fire extinguishing system	<b>EI 90</b>	<b>EI 90</b>
5.	High buildings equipped with automatic fire-fighting system	<b>EI 60</b>	<b>EI 60</b>
6.	Very high buildings	<b>EI 90 (h &lt; 75 m)</b> <b>EI 120 (h ≥ 75m)</b>	<b>EI 90 (h &lt; 75 m)</b> <b>EI 120 (h ≥ 75 m)</b>

**Note:** The minimum fire reaction class of vertical and/or horizontal partitioning elements is **minimum A2s1d0** on the level I of fire stability.

**'h'** = elevation of the last accessible/usable floor of the construction from the reference level

## **2.4.8. Provisions for constructive compositions specific to limiting the spread of fire on the roof**

### **2.4.8.1. Attic free roofs**

**Article 2.4.8.1.1. (1)** Attic free roofs shall be made of construction products corresponding to the provisions of the legislation on ensuring the level of fire stability of the construction, according to the provisions of **Article 2.1.3.2** and those in Table 2 and Table 3 of the Rule.

**(2)** The continuity of the combustible components of non-attic roofs shall be interrupted at least against the compaction-expansion or seismic joints of the construction in such a way as to limit the propagation of combustion. Interruption of continuity is achieved by continuous strips of materials of the reaction to fire class **A1** or **A2-s1d0** of a width of not less than **1 m** or protective measures shall be provided for the combustible components of roofs over the normal width of the cut-off strip.

### **2.4.8.2. Green roofs**

**Article 2.4.8.2.1. (1)** In green roofs, the following shall be ensured:

- a)** the minimum thickness and composition of the substrate for vegetation;
- b)** the use of plant types which do not present a fire risk;

c) provision of minimum perimeter strips **50 cm** width, between vegetation zone and cover edge, attic, handrails, skylights, penetrators, etc., made of products/materials of reaction to fire class products/materials **A1** or **A2-s1d0**;

d) achieve barriers of at least height **30 cm** at a range of not more than **40 m**, executed from materials of the reaction to fire class **A1** or **A2-s1d0** of at least **1 m** width or, alternatively, continuous horizontal protection strips of minimum **10 m** width for extensive green roofs and minimum **1 m** width for intensive green roofs, within a range of not more than **40 m**, made of materials classified as reaction to fire **A1** or **A2-s1d0**, provided between vegetation zones or provision of an external fire performance class **B<sub>(ROOF)</sub>(T4)** for previous continuous horizontal roofs/strips;

e) interruption of the continuity of the combustible components of green roofs at least next to the compaction-expansion or seismic joints of the construction, according to the provisions of the specific technical regulations.

(2) Given that at least one of the escape stairways in high buildings and at least two of the escape stairways of the very high building must have access to the terrace above the last level (which is a refuge for users of the types of buildings mentioned in the event of an exceptional situation), the green terrace (garden) space in the immediate vicinity of stairways starting on the roof (terrace), in an area of min. **20 m<sup>2</sup>** or min. **1/5** of the surface of the roof (to terrace roofs with a surface larger than **100 m<sup>2</sup>**), shall be provided with slabs with non-combustible elements, according to the Guide on the design and execution of green roofs in new and existing buildings.

**Article 2.4.8.2.2.** The fire stability level of buildings with a green roof shall be determined according to **Article 2.1.3.2.**, Table 2 and **Article 2.1.3.3.**, relating to the minimum reaction and fire resistance requirements of coatings and continuous support for combustible coatings.

## 2.4.9. Atriums

**Article 2.4.9.1. (1)** Atriums may be uncovered or covered (*according to terminology*). The provisions of the Rule refer to enclosed and covered or uncovered atriums with a minimum height of four levels of construction in which they are arranged and of a width of at least  $\sqrt{7H}$  of their height (in which H is the smallest atrium height).

(2) Narrower atriums (width less than  $\sqrt{7H}$ ) which do not fulfil the condition set out in **paragraph 1** may only be achieved if additional fire safety measures are taken to prevent the transmission of fire from one level to another through the flue effect.

**Article 2.4.9.2. (1)** Atrium whose free volume is closed on all sides and whose minimum width is less than or equal to the height of the uppermost face and which is open at least at the top **90 %** is considered an uncovered atrium (**Figure 2** of terminology).

(2) Atrium whose dimensions are given in **paragraph 1** and which is fully or partially covered (more than 10 %) is considered a covered atrium. Two types of covered atriums are distinguished in this category:

- open covered atriums are volumes in which one or more levels are permanently opened to the central volume (**Figure 2** of terminology).
- enclosed covered atriums are the volumes where all levels (except the lower level) are closed laterally by walls, even if gaps exist in these lower level walls, or if the levels have cursive balconies or open horizontal circulation between the walls and the volume of the atrium

(3) The provisions of **Article 2.4.9.3.** to **Article 2.4.9.10.** of the Rule refer to covered atriums, which have a projection of the smallest width  $\sqrt{7H}$  (where H is the smallest atrium

height) and having at least four levels on one or more sides of the building adjacent to the atrium. Covered and uncovered atriums not falling under the above conditions shall, in addition, comply with the provisions of **Article 2.4.9.11**.

**Article 2.4.9.3.** *Perimeter closures of atriums to the outside of the construction must comply with the performance criteria set out in **Table 2** for external walls, except for curtain walls which shall not be fire-resistant.*

**Article 2.4.9.4. (1)** When the atrium perimetally separates itself by glazed joinery panels from the construction in which it is arranged, it shall not favour the propagation of fires from one level to the next of the building.

**(2)** Successive vertical glazed joinery shall be separated by continuous full areas (bulkheads), at least fire-resistant **EI 60** for the level **I and II** of fire stability, i.e. minimum **EI 30** for the other levels of fire stability and the minimum height of **1.20 m** or through continuous horizontal fire resistant areas (floors/covers) **REI 60** for the level of **I and II** of fire stability, i.e. minimum **REI 30** for other levels of fire stability and width of at least **1.20 m** (measured horizontally).

**(3)** It is permissible to aggregate the width of the continuous shell (floor) with the height of the continuous full area (bulwark) in order to ensure the size of **1.20 m** referred to in **paragraph 1**.

**Article 2.4.9.5 (1)** Horizontal common paths open to the atrium are provided at their boundary to the atrium with continuous screens placed below the floors, with a height of at least **50 cm** and minimum fire resistance **DH 60** for the level **I and II** of fire stability, i.e. minimum **DH 30** for other levels of fire stability and with suitably located sprinklers with minimum service life **60** minutes, if adjacent spaces are equipped with such facilities.

**(2)** Continuous beams of the structure having a height of at least **50 cm** underneath the floor, as well as those less than **50 cm**, under which continuous fire resisting screens can be made according to **paragraph 1**, such that together (beams and screens) have a minimum **50 cm**.

**(3)** Horizontal common paths open to the atrium of functions for health, accommodation, education, commerce, exhibitions and the like shall be provided with smoke and hot gas exhaust systems in the event of fire, and no excess pressure ventilation is permitted. All communications from spaces adjacent to horizontal common paths open to the atrium, with functions for health, accommodation or education shall be protected by fire resistant doors that are as low as possible, but not less than **EI 30-C**.

**Article 2.4.9.6.** *If walls are provided to separate atriums from the rest of the building, they shall be fire-resistant **EI** corresponding to the density of the heat load (**q**) in adjacent spaces, as provided for in **Article 2.3.1.2** and **Table 5**, but minimum **EI 60** for the level **I and II** of fire stability, i.e. minimum **EI 30** for the other levels of fire stability.*

**Article 2.4.9.7. (1)** Fixed and mobile equipment in atriums shall not exceed the density of the heat load (**q**) of **420 MJ/m<sup>2</sup>**.

**(2)** In determining the density of the heat load (**q**), the area of the highest level of the atrium bounded by the walls, apart from the first level of the atrium, shall be taken into account.

**(3)** Finishes of atriums and common horizontal paths open to the atrium shall be made of materials of the reaction to fire class **A1** or **A2-s1d0**, respectively **A1<sub>FL</sub>** or **A2<sub>FL</sub>-s1**.

**Article 2.4.9.8.** Skylights covering atriums shall be constructed with profile structures of the reaction to fire class **A1** or **A2-s1d0**, except for non-substantial components, insulators and fittings, with filling panels of glazing elements (glass) only or insulating, or of products for reaction to fire **A1** or **A2-s1d0**.

**Article 2.4.9.9.** Where spaces of high or very high fire risk are provided adjacent to the atrium (trade, exhibitions and similar with heat load density – q above **840 MJ/m<sup>2</sup>**), these spaces must be equipped with detection, signalling and alarm systems and fire extinguishing machines.

**Article 2.4.9.10.** Deposits of combustible materials and/or substances shall be separated from atriums with fire resistant elements, composed and sized according to the density of the heat load (q) of those stores, but minimum **EI 120**.

**Article 2.4.9.11. (1)** In the production of atriums, patio or glass-roofed courts on less than **4** levels and covered areas with a height of at least **1.20 m** between the levels, next to the floors, must be **E 30**.

**(2)** In the production of narrower covered atriums (width less than  $\sqrt{7H}$ ) other than those from **Article 2.4.9.1.**, the flue effect in the event of fire is increased and one of the following additional measures shall be taken:

**a)** walls provided for in **Article 2.4.9.6.** must be resistant corresponding to the density of the heat load (q) in adjacent spaces, according to the provisions of **Article 2.3.1.2.** and **Table 5**, but minimum **EI 90** for level **I** and **II** of fire stability, respectively minimum **EI 60** for the other levels of fire stability.

**b)** provision, at the atrium boundary, of continuous screens placed under the floor, with a height of at least **50 cm** and minimum fire resistance **DH 90** for the level **I** and **II** of fire stability, respectively minimum **DH 60** for the other levels of fire stability, as well as perimeter water curtains with automatic entry into operation and minimum service life **60 minutes**.

**(3)** Provisions to limit the spread of fire on the facade shall apply to uncovered atriums.

#### **2.4.10. Galleries, canals, trestles**

**Article 2.4.10.1. (1)** When passing over construction and are intended for the escape of users, galleries, channels and trestles shall be provided in those portions with minimum fire-resistant walls **EI/REI 120** and minimum fire-resistant floors **REI 90**. The use of galleries, trestles and passageways intended for the escape of users shall also be permitted for liquid or gas transmission pipelines the mixture of which is not capable of initiating fire or volumetric explosion or which does not affect the escape in the event of their damage.

**(2)** In galleries, canals or trestles, the unseparated fitting of pipelines or transport systems for liquids or gases, the mixture of which may initiate fire or volumetric explosion, shall not be permitted.

**(3)** Closed galleries, canals and trestles with a built-up area larger than **800 m<sup>2</sup>** whereby combustible materials or substances are transported, shall have ensured possibilities for the exhaust of smoke and hot gases in the event of fire, by means of natural and organised draught (minimum **1 %** free useful/aerodynamic surface in the floor area of the room) or by mechanical ventilation. Galleries, trestles and walkways intended for the escape of users, closed and with longer lengths of **50 m**, shall have ensured possibilities to evacuate smoke and hot gases in the event of fire by natural and organised draught (minimum **1 %** useful/aerodynamic surface in the floor area of the room) or by mechanical ventilation.

**(4)** At the entrance to buildings of closed channels, galleries and trestles of all kinds, such voids shall be protected according to the nature of the materials from which they are made and those being transported, the destination of the spaces to which it is intended and the role of the wall in ensuring the fire safety of the construction, with active or passive fire resistant elements of minimum fire safety **EI 60**.

**(5)** Are exempted from **paragraph 4** open galleries, channels and trestles made of fire resistant elements **R 15** whereby non-combustible materials are transported, in which case the

protection of voids is mandatory only when they pass through fire resistant walls delimiting fire compartments.

#### **2.4.11. Niches for installations**

**Article 2.4.11.1.** In buildings, the walls of all vertical niches for installations (ducts, cables, tubes, pipes, etc.), hatches and their doors shall be constructed from non-combustible materials and the gaps in the passage of the installations relating to the construction, as well as between them and the through-element, shall be protected by materials/systems of minimum fire resistant components **EI** as required by **Table 2 point 3** and **Table 3 point 3** for floors, except in the cases specified in the Rule for building types and in specific technical regulations.

**Article 2.4.11.2. (1)** Where the gaps of the passing niches for the installations relating to the construction, as well as between them and the through-element, **shall protected** with materials/systems of at least fire-resistant composition **EI** as required by **Table 2 point 3** and **Table 3 point 3** for floors, vertical girdles for installations shall be separated from the rest of the normal height building through the walls with reaction to fire class **A1, A2s1d0** of a minimum fire resistance

- **EI/REI 30** and their doors or hatches shall be made of materials **A1, A2s1d0** in buildings with a level **I, II** or **III** of fire stability

- **EI/REI 15** and their doors or hatches shall be made of materials **A1, A2s1d0** in buildings with level **IV** of fire stability

In all cases, their doors or hatches shall not be placed in escape staircases.

**(2)** When sealing installations (pipes, tubes, ducts, etc.) and cables in vertical niches for installations next to floors **is not technically possible or justified**, the niche walls shall have the reaction to fire class **A1, A2s1d0** with a minimum fire resistance of:

- **EI/REI 90** and their doors or apertures shall be made of materials **A1, A2s1d0** of a minimum fire resistance **EI 60** in buildings with a level **I** of fire stability

- **EI/REI 90** and their doors or apertures shall be made of materials **A1, A2s1d0** of a minimum fire resistance **EI 45** in buildings with a level **II** of fire stability

- **EI/REI 60 (EI/REI 45** if the construction is fitted with automatic sprinkler facilities) and their doors or hatches shall be made of materials **A1, A2s1d0** of a minimum fire resistance **EI 30** in buildings with a level **III** of fire stability

- **EI/REI 30** and their doors or hatches shall be made of materials **A1, A2s1d0** of a minimum fire resistance **EI 15** in buildings with a level **IV** of fire stability

- **EI/REI 15** and their doors or hatches shall be made of materials **A1, A2s1d0** in buildings with a level **V** of fire stability

In all cases, their doors or hatches shall not be placed in escape staircases.

**(3)** Specific provisions shall apply to high, very tall buildings with crowded, underground and mixed rooms.

**(4)** When passing through fire resistant elements delineating the fire compartments, the niches for installations shall be closed around tubes, ducts and cables with materials in constructive constructions which provide fire resistance equivalent to that of the through-element.

**(5)** Vertical niches shall be separated when passing through floors delineating fire compartments with elements and materials with reaction class to fire **A1, A2s1d0** which shall provide the same fire resistance as the through-floor, and when separation is not technically possible or justified, the niche walls shall be of materials **A1, A2s1d0** minimum **EI/REI120** and their guest doors (hatches) shall be of material **A1, A2s1d0** minimum **EI60**.

#### **2.4.12. Chimney sweets, stoves, hoods**

**Article 2.4.12.1. (1)** Chimneys, stoves and, in general, equipment, apparatus and local space heaters or radiating heat shall be made up, executed, insulated from the combustible elements of the construction and shall be used according to the provisions of the technical regulations applicable to

the field concerned, so that they do not initiate fires by means of convection, conduction or radiation. Chimneys shall be designed, installed and put into service according to **SR EN 15287-1** and **SR EN 15287-2** or other equivalent regulations. Chimneys shall be tested according to **SR EN 13216-1** and must meet minimum criterion G 100.

(2) Chimney below **1.50 m** in a horizontal plane, by the heel of the roof, must exceed the coping of the roof with minimum **50 cm** for non-combustible coverings, respectively **1 m** for combustible coverings. Chimney placed at distances greater than **1.5 m** in relation to the height of the coping of the roof shall be at least **1 m** in relation to the covering. The height of the chimney above the terrace of the roof must be at least **1 m**. Chimneys must go beyond at least **50 cm** height of the terrace elevation elements (attic, fire walls, etc.) when they are less than **3 m** from the edge of the terrace in question with a minimum **1 m** when located **3 m** above the edge of the terrace. The minimum height of placement of the 'air suction' chimney in relation to the pedestrian area shall be minimum **1.80 m**.

(3) For thermal power stations located at the last level or on the terrace of the building, it is recommended to use boilers with excess pressure in the combustion chamber which require flue gases to be discharged from low heights.

(4) In kitchens where the total rated heat output (summed) of food preparation or heating appliances exceeds **20 kW**, the following conditions must be met:

a) hoods, exhaust pipes and generally heat capture devices shall be made of materials of the reaction to fire class **A1**;

b) hoods and exhaust pipes shall be located at least one **1 m** away from combustible elements and materials or properly insulated;

c) the heat exhaust pipes shall be fire-tight **E 30 i↔o**, **ve** or **ho** within the room served, and at penetrations through walls and floors as well as through rooms for another purpose, heat exhaust ducts related to hoods shall be made of materials of the reaction to fire class **A1** and shall ensure the fire resistance equal to that of the attic parts, but not less than **EI 60 h<sub>0</sub>i↔o** or **EI 60 ve<sub>i↔o</sub>**, depending on the position in which they are mounted (vertically or horizontally);

d) the exhaust fans of the hoods shall be fire-resistant **F<sub>400</sub>90**

e) connections between the associated exhaust fans and the ducts shall be at least the reaction class to fire **A2-s1d0**.

f) The exhaust pipes shall be independent of any other extraction or ventilation and shall be exclusive for each galley

(5) The outdoor ducts of the hoods shall be provided for in front of non-combustible full portions of the building with a minimum width of **1.00 m** measured from the outer edge of the duct.

**Article 2.4.12.2.** (1) Hoods for capturing heat releases produced by equipment, devices, apparatus, etc. shall be made of class materials **A1** or **A2-s1d0** reaction to fire and insulated from combustible elements and materials within a distance of **1 m**.

(2) The piping associated with them shall be made of class materials **E 30 i↔o**, **ve** or **ho** and insulated from combustible elements and materials within a distance of **1 m**.

(3) At crossing through walls and floors, as well as through rooms for other purposes, heat exhaust ducts related to hoods shall be made of materials of the reaction to fire class **A1** and shall ensure the fire resistance equal to that of the attic parts, but not less than **EI 60 h<sub>0</sub>i↔o** or **EI 60 ve<sub>i↔o</sub>**, depending of the position in which they are mounted (vertically or horizontally).

### ***2.4.13. Constructional compositions specific to the risk of volumetric explosion***

**Article 2.4.13.1.** When constructing independently sited volumetric explosion buildings, the use of lightweight building elements is recommended and the roof of these buildings must be attic free.

**Article 2.4.13.2. (1)** When technically justified in construction for other purposes – rooms at risk of volumetric explosion – they shall be separated from the rest of the construction with bulk-resistant walls and floors, the reaction to fire class **A1** composed and sized according to the standardised provisions.

**(2)** Floors and their supporting elements shall be calculated, designed and constructed in such a way that they are not displaced by the blast of the explosion.

**Article 2.4.13.3.** Rooms and spaces with explosion hazard shall not have suspended or self-supporting ceilings and non-ventilated areas that facilitate the production of dangerous air concentrations with combustible gases, vapours or dust. In the release of combustible dust, the finish shall allow cleaning up the areas.

**Article 2.4.13.4. (1)** In volumetric explosion-resistant separation walls, only the gaps strictly necessary for their function shall be permitted, provided that they are protected according to the provisions of this Rule and the specific technical regulations.

**(2)** Passing through explosion-resistant walls by pipes, conductors or electric cables shall be permitted only where strictly necessary and subject to protective measures to prevent the passage of vapour, gas and combustible dust in addition to them.

**Article 2.4.13.5.** Buildings and rooms at risk of volumetric explosion shall be provided with gaps for decompression in case of explosion, constructed and sized according to the standardised provisions. The decompression cells shall be located in the vicinity of the sources of explosion, taking into account that the effect of the blast of the explosion outside its construction does not affect invaded objects or public movement paths.

**Article 2.4.13.6.** Gaps to be provided for decompression in case of explosion may be unclosed or closed. The components for closing the voids for decompression shall be such that they fail at the pressure due to the volumetric explosion, but not more than **118 daN/m<sup>2</sup>**.

**Article 2.4.13.7.** For buildings, rooms and areas at risk of volumetric explosion, it is mandatory to specify and mark the zoning of the risks of volumetric explosion, as well as the protective measures provided, according to the provisions of the specific technical regulations.

**Article 2.4.13.8.** In spaces where explosive mixtures of air with gases, vapours or dust may occur, the surface wear layer of the floor coverings shall be made of materials which do not cause sparks which, upon impact, are not capable of initiating ignition of such explosive mixtures.

**Article 2.4.13.9.** In rooms and spaces with an explosion hazard, joinery and its actuating systems shall be so constructed or protected that, by handling, they do not produce sparks capable of initiating ignition of explosive mixtures.

**Article 2.4.13.10.** The demarcation of the zones up to which the protective measures required by the risks of volumetric explosion (zoning of environments with explosion hazard) are extended, considers the possibility of air mixtures with gases, vapours or dust in concentrations at risk of explosion during normal operation.

#### ***2.4.14. Rooms and spaces for utility installations relating to buildings***

**Article 2.4.14.1. (1)** Rooms for thermal power stations and heat points for hot water or super-heated central heating systems and electrically-powered heaters shall be separated from the rest of the construction with minimum fire-resistant walls **EI/REI 90** and minimum fire-resistant floors **REI 90** reaction class to fire **A1** or **A2-s1d0**, with the exceptions permitted in the profile regulation (individual thermal power stations may be located inside the building or on its terrace,



mainly according to the provisions of the technical regulations relating to the design, construction and operation of small thermal power stations, fire safety in buildings, specific technical prescriptions **ISCIR** etc.).

(2) Small forced draught thermal power stations with installed capacities up to **0.3 MW** ( $P_i < 300 \text{ kW}$ ) can be installed and operated in residential buildings (bathrooms, kitchens) and ordinary public buildings (inside specially built rooms) without the requirement to separate them from other rooms with walls and floor according to **paragraph 1** but in compliance with the provisions of the technical regulations on the design, execution and operation of small thermal power stations, specific technical prescriptions **ISCIR**.

(3) Access to thermal power station rooms related to residential buildings of a capacity exceeding **0.3 MW** ( $P_i > 300 \text{ kW}$ ) can be done directly from the outside and when it is technically not possible to do so, access from the construction must be protected by a buffer space.

(4) Natural thermal power stations with a watertight chamber shall be installed on non-combustible walls and, where this is not possible, the installation of natural thermal power stations on combustible materials shall be made by interconnecting non-combustible materials between them and the combustible material or distancing elements which may be: plastering of 1 cm thickness or more, or plates of non-combustible electro-insulation materials of thickness or more **0.5 cm** of a width exceeding by at least **3 cm** on all sides of the natural thermal power station or supporting elements of non-combustible materials (e.g. metal consoles, etc.) that distance the mural thermal power station by at least **3 cm** on all sides of the combustible element.

(5) In buildings of different heights, the thermal power station room shall be placed on the roof of the terrace of the building at the greatest height. Thermal power stations located on terraces must comply with the following conditions:

a) In buildings of different heights, the thermal power station room shall be placed on the roof of the terrace of the building at the greatest height;

b) The installation of the thermal power station on the terrace shall be carried out without affecting the safety and proper functionality of the building and its supporting structure;

c) Access to thermal power stations located on the terrace of the building shall only be possible from the terrace or the staircase through a buffer space; direct access from a lower floor through openings or hatches in the floor of the thermal power station shall not be permitted;

d) Small individual thermal power stations (with an installed power  $P_i$  less than 300 kW) may be located inside or on the terrace of the building, in particular by complying with the provisions of the technical regulations relating to the design, execution and operation of small thermal power stations, the technical prescriptions specific to the **ISCIR**, etc.

e) Medium thermal stations (with capacities between **0.3 MW** and **2 MW**) it is recommended to be located at levels above the ground floor (to take place only on the last floor of the building or on its terrace, in individual premises or adjacent to other technical spaces);

f) Thermal power stations operating with gaseous and liquid fuel may be used in thermal power stations located on the terrace of the building provided that the fuel stock is limited to the equivalent value of the daily tank, with a capacity not exceeding **2 mc**; the liquid fuel tank for daily consumption shall not be fitted above the boilers, but sideways, at least at a distance of **2.50 m** away from the injectors, not in the direction of any misfire or flue gas, when opening explosion dampers;

g) For thermal power stations located on the terrace of the building, it is recommended to use boilers with excess pressure in the combustion chamber which require flue gases to be discharged from low-height chimneys.

(6) Functional communication gaps with the rest of the construction of the rooms referred to in **paragraphs 1-4** shall be protected with fire resistant and smoke tight doors **EI<sub>2</sub> 15-C5S<sub>200</sub>** opening outside the room.

(7) Small thermal power stations with an installed capacity ( $P_i$ ) less than **300 kW** using gaseous fuel and in which the flue-gas discharge shall be carried out by forced draught, may be installed in rooms for another purpose under the conditions of the specific technical regulations, without applying the provisions of the **paragraphs 1-6**; constructive prescriptions on the location conditions of small thermal power stations (apartment, block etc.) with capacity below **0.3 MW** ( $P_i < 300 \text{ kW}$ ), are laid down in the technical regulations for the design, execution and operation of small thermal power stations.

(8) Thermal power stations incorporated into buildings shall not be located:

- a) in and under rooms with a very high risk of fire or a risk of volumetric explosion, nor attached thereto, except as permitted by specific regulation;
- b) in and under crowded rooms and escape routes of crowded rooms under scenes and under crowded rooms;
- c) in and under the day rooms and bedrooms of communities for pre-school children and their attachments;
- d) aggregated, in and under classrooms, laboratories or gymnastic rooms in educational buildings;
- e) in hospital or hospital buildings, under sick lounges or operating rooms, or attached thereto;
- f) in the basement or semibasement of buildings, if liquefied petroleum gas is used as a fuel (**LPG**);
- g) inside high and very high buildings, with the exception of parts of buildings that do not reach that height, with the exception of small apartment thermal power stations, with an installed power ( $P_i$ ) less than **300 kW** using gaseous fuel and in which the flue-gas discharge is carried out by forced draught;
- h) in spaces of high and very high fire risk in civil buildings, with the exception of buildings or their doors with commercial functions, small thermal power stations with an installed capacity ( $P_i$ ) less than **300 kW** using gaseous fuel and in which the flue-gas discharge is carried out by forced draught;
- i) in areas of very high fire risk in production buildings.

(9) Small thermal power stations with an installed capacity ( $P_i$ ) less than **300 kW**, using gaseous fuel and where flue gas discharge is carried out by forced draught, may be installed in construction/production and storage facilities, provided that their different rooms are separated, with separation elements according to the provisions of paragraphs **1 ÷ 6**

(10) Thermal power stations using natural gas as fuel shall also be located in compliance with the specific technical rules on the design, execution and operation of natural gas supply systems, and the location of liquefied petroleum gas-fired thermal power stations shall also be carried out in compliance with the specific technical rules on the design and execution of liquefied petroleum gas supply systems.

(11) At thermal power stations using natural gas and liquefied petroleum gas, the surface of the external windows shall also satisfy the conditions laid down in the technical rules for the design, execution and operation of natural gas and liquefied petroleum gas supply systems, concerning the ratio between the glazed surface and the volume of the boiler room, and the positioning of the required glazed surfaces shall be determined in such a way as not to block in the event of explosion, escape routes and intervention access routes.

(12) Thermal power stations equipped with hot water boilers with a pressure greater than **0.5 bar** shall also comply with the technical conditions laid down in the specific technical prescriptions **ISCIR**.

(13) Thermal power stations shall not be located along the routes of the escape routes.

**Article 2.4.14.2. (1)** Fan rooms, filters, dedusting chambers and cyclones through which gases, vapours, dust or combustible waste are transported shall be separated from the rest of the

construction with minimum fire and explosion resistant walls **EI/REI 180** and, where applicable, with a minimum floor **REI 120**.

(2) Access to the rooms referred to in **paragraph 1** shall be provided directly from the outside and when it is technically not possible, access from the construction shall be compulsorily protected by protected buffer room ventilated in excess pressure, made up and carried out according to the provisions of the Rule.

**Article 2.4.14.3. (1)** When provided on the roof, ventilation/conditioning/air-conditioning plant rooms shall be separated from other construction purposes by minimum fire resistant elements **EI/REI** for walls, and **REI** for floors and access gaps are protected by doors **EI-S<sub>a</sub>**, with the exception of those starting outwards, according to the provisions of the profile standard.

(2) In buildings of different heights, where the room for ventilation or air-conditioning plants or outdoor units are located on the roof of the building, they shall be arranged at a distance of at least **4 m** compared to the external walls of the higher building, if gaps are provided in them. In the event that the distance of **4 m**, the aforesaid gaps shall be protected with elements **EI<sub>2</sub> 60-C2S<sub>a</sub>**, and the wall in which the gaps are arranged shall be fire-resistant minimum **REI 60' (A1 or A2-s1, d0)** on a zone of minimum **8 m** measured vertically and horizontally from the contour of all ventilation and air-conditioning plants/aggregates or the room of ventilation or air-conditioning plants shall have fire resistance walls of at least **REI 60 (A1 or A2-s1, d0)** the gaps in these walls are protected with elements **EI<sub>2</sub> 60-C2S<sub>a</sub>** and the roof shall have a minimum fire resistance **REI60** and coatings **A1, A2-s1, d0** or **B-s1, d0**.

(3) Smoke and hot gas exhaust fans shall be installed in one of the following variants:

a) outside the building, according to the provisions of the dedicated chapter of the Rule;

b) in exceptional cases in a technical space separated from the rest of the construction by building elements of the class reaction to fire **A1** or **A2s1d0** with walls **EI 60** and fire resistant floors **REI 60**; the room access door shall be **EI 60-C3S<sub>a</sub>** when the tubing is tight or resistant to fire **30** or **60** minutes (mono or multi). Where different tubing is foreseen, the technical space shall be separated from the rest of the construction by building elements of the reaction to fire class **A1** or **A2s1d0** with walls **EI 120** and fire resistant floors **REI 60**; the room access door shall be **EI 60-C3S<sub>a</sub>**.

(4) In the separation elements of the ventilation/conditioning/air-conditioning/air-conditioning plant rooms from the rest of the construction shall not be permitted to perform gaps other than those for access, as well as for ducts, cables and pipes for ventilation/air conditioning areas, which are protected according to the provisions of this Rule and the specialised technical regulations.

(5) Penetrating fire resistant bulkheads separating fire compartments (fire walls) by ducts, ventilation-conditioning channels shall be permitted only if the sealing/closing condition with fire-resistant materials for minimum **180** is satisfied. Where this condition cannot be met by the maximum characteristics of the materials available, niches may be made which, by summation with the fire resistance of the available materials, give rise to the summation condition of three-hour fire-resistant composition under expected end-use conditions (tested).

(6) The passage of fire resistant walls by ducts, ventilation-conditioning channels, etc. is permitted only if the sealing/closing condition with fire-resistant materials having the same fire resistance as the bulkhead is satisfied. When this condition cannot be met by the maximum characteristics of the materials available, niches may be made which, by summation with the fire resistance of the available materials, give rise to the necessary summation condition of fire resistant composition under expected end-use conditions (tested). Vertical niches for installations shall be separated from the rest of the buildings by fire resistant walls under standardised conditions and their doors and hatches shall be fire-resistant under standardised conditions. Vertical niches for installations shall be sealed around ducts and cables when passing through floors with materials having the same fire resistance as the element crossed. When it is not possible (or technically justified) to seal vertical niches for installations next to the floors, the bulkheads shall be as fire-resistant as a minimum **EI/REI** equivalent to the one of the floors they intersect (floor with the most restrictive fire resistance) according to their classification with the level of fire stability specified in Table 2 and Table 3, and their doors or buttons shall meet the standardised conditions.

When passing through fire-resistant elements, the niches for installations shall be closed around tubes and ducts with materials in constructive compositions that provide fire resistance equivalent to that of the crossed element.

**Article 2.4.14.4. (1)** Fire-extinguishing water households arranged in buildings (pumping stations, water reserves, related equipment and appliances, etc.) and providing a higher extinguishing flow rate of **4.2 L/s** shall be separated from the rest of the construction with elements of the class reaction to fire **A1** or **A2-s1d0** fire resistant corresponding to the heat load density (q) in adjacent rooms, but minimum **EI/REI 180** for walls and minimum **REI 90** for floors.

**(2)** Fire-extinguishing water pumping station providing a higher flow rate of **4.2 L/s** may communicate with the rest of the construction through a fire-resistant door functional gap **EI<sub>2</sub> 90-C3** or by protected buffer room ventilated under excess pressure and fitted with fire resistant doors **EI<sub>2</sub> 45-C3**.

**(3)** In the room of the fire-extinguishing water pumping station providing a higher flow of **4.2 L/s**, only the installations, devices and apparatus specific to this function may be fitted and an external access path (direct door from the outside or from a common traffic ladder) shall be provided.

**(4)** Fire-fighting water pumping stations providing a flow rate less than or equal to **4.2 L/s** shall be separated from the rest of the construction with elements of the reaction to fire class **A1** or **A2-s1d0**, fire resistant corresponding to the heat load density (q) in adjacent rooms, but minimum **EI/REI 60** for walls and minimum **REI 45** for floors. The station may communicate with the rest of the construction through a fire-resistant door functional void **EI<sub>2</sub> 30-C3** and the external access (direct door from outside or from a common traffic ladder) is not mandatory. The station may have access from a hall/corridor directly linked to an outward escape stairway or escape stairway with a direct outboard outlet.)

**(5)** The protection measures set out in **paragraph 1** and **2** and **3** are also mandatory for separate rooms in which the basic and back-up sources of fire-fighting water pumping stations are located (trafo stations, generating sets, heat motor pumps).

**(6)** Generating sets constituting emergency electrical sources feeding fire protection devices may be located in one of the following variants:

a) own rooms separated from the rest of the construction by the fire reaction class bulkheads **A1, A2s1d0**, without gaps (except functional ones) with minimum fire resistance **(R) EI180** fitted with doors **EI<sub>2</sub>90-C3** with easy access from the outside and minimum floors **REI 90**.

b) outdoor, on open platforms, located at minimum safety distances specified in **Article 2.2.1.2.** and **Table 4** (considering the group with the level **II** of fire stability) but minimum **6 m** to the building.

**(7)** Generating sets constituting back-up electrical sources shall not be placed on the roof of buildings

**(8)** Transformer substations may be fitted in one of the following variants:

a) own rooms separated from the rest of the construction by the fire reaction class bulkheads **A1, A2s1d0**, without gaps (except functional ones) with minimum fire resistance **(R) IT 180** and minimum floors **REI 90** with access only from the outside;

b) in open buildings (sheds) made entirely of materials classified as reaction to fire **A1** or **A2-s1, d0** or on open platforms, located at minimum safety distances specified in **Article 2.2.1.2** and **Table 4** (considering the transformer located on the open platform with the level **II** of fire stability) but minimum **6 m** to the building.

## **2.4.15. Waste chambers, compactors and cremators**

**Article 2.4.15.1. (1)** Dry and wet waste bins, compactors and crematoria shall be separated from the rest of the building, with vertical and horizontal building elements the reaction to fire class **A1** minimum fire resistant **EI/REI 180** for walls, and **REI 90** for floors and the entrance gap in the construction shall be protected with a fire-resistant and smoke tight door **EI<sub>2</sub>90-C5S<sub>200</sub>**. Exception are the cases specified in the legislation, where communication is permitted only through protected buffer rooms, suitably constituted and ventilated under excess pressure.

**(2)** Dry and wet waste blast furnace chambers and chambers with a surface greater than **36 m<sup>2</sup>** which do not have windows outwards, shall have ensured the exhaust of smoke and hot gases in the event of fire by natural and organised draught (minimum) **1 %** free useful/aerodynamic surface in the floor area of the room for smoke exhaust) or by mechanical ventilation, according to the provisions of the Rule.

**(3)** In high and very high buildings, access gaps in the building shall be provided with protected buffer rooms, ventilated in excess pressure, with fire resistant doors and smoke tight as a minimum **EI<sub>2</sub> 60-C3S<sub>200</sub>** and blast furnace chambers shall be separated from the rest of the construction with minimum fire resistant walls **EI/REI 180** and minimum floors **REI 120** reaction class to fire **A1**.

**Article 2.4.15.2. (1)** Tubes for waste or other materials (linen, etc.) or substances are made of materials classified as reaction to fire **A1** or **A2-s1d0** and access from the building levels shall be provided from the outside (logs, balconies, curves, terraces) or into rooms inside the building made with fire-resistant walls **REI 180** and floors **REI 90** reaction class to fire **A1** or **A2-s1d0**.

**(2)** In buildings with normal height gaps in the building to rooms for waste or other materials (linen, etc.) or piping substances shall be protected by fire resistant doors and smoke tight doors **EI<sub>2</sub> 90-C5S<sub>200</sub>** above ground, i.e. fire resistant and smoke tight doors **EI<sub>2</sub> 120-C5S<sub>200</sub>**, in the underground.

**(3)** In high and very high buildings, as well as buildings with crowded rooms, the gaps of access in the building to the rooms for waste or other materials (linen, etc.) with tubing shall be protected by buffer rooms, ventilated in excess pressure, fitted with fire resistant doors and smoke tight **EI<sub>2</sub> 60-C5S<sub>200</sub>**, separated from construction with minimum fire resistant walls **EI/REI 60** and minimum floors **REI 60** reaction class to fire **A1** or **A2-s1d0** above ground, i.e. with fire resistant and smoke tight doors **EI<sub>2</sub> 90-C5S<sub>200</sub>**, separated from construction with minimum fire resistant walls **EI/REI 120** and minimum floors **REI 90** reaction class to fire **A1** or **A2-s1d0** in the underground.

## **2.4.16. Storage rooms**

**Article 2.4.16.1. (1)** Storage rooms for combustible materials and substances may be incorporated into civil or production structures when required for functional reasons, provided they have ensured the fire safety conditions and measures laid down in the Rule and applicable specific technical regulations.

**(2)** The handling, processing or storage of materials and substances of a volumetric explosion risk, as well as the location of workshops where such materials are used, except in laboratories, pharmacies, hospitals, etc., shall not be permitted in civil above-ground or underground construction.

**Article 2.4.16.2. (1)** Storage rooms for combustible materials and substances with useful area larger than **36 m<sup>2</sup>** embodied in civil buildings shall be compulsorily separated from the rest of the construction by walls and floors **A1** or **A2-s1d0**, as set out in Table 21.

**Table 21: Minimum conditions for separation of storage rooms > 36 m<sup>2</sup> of civil buildings**

Lev. stab.	Construction elements	THERMAL LOAD DENSITY			
		$q < 420 \text{ MJ/m}^2$	$420 \text{ MJ/m}^2 \leq q < 840 \text{ MJ/m}^2$	$840 \text{ MJ/m}^2 \leq q < 1680 \text{ MJ/m}^2$	$\geq 1680 \text{ MJ/m}^2$
I*	Walls	<i>EI/REI 60 (45)<sup>#</sup></i>	<i>EI/REI 120 (90)<sup>#</sup></i>	<i>EI/REI 180 (120)<sup>#</sup></i>	<i>EI/REI 240 (180)<sup>#</sup></i>
	Floors	**	**	<i>REI 120 (90)<sup>#</sup></i>	<i>REI 180 (120)<sup>#</sup></i>
	Doors	<i>EI<sub>2</sub>30-C3S<sub>200</sub> (EI<sub>2</sub>20-C3S<sub>200</sub>)<sup>#</sup></i>	<i>EI<sub>2</sub>60-C3S<sub>200</sub> (EI<sub>2</sub>45-C3S<sub>200</sub>)<sup>#</sup></i>	<i>EI<sub>2</sub>90-C3S<sub>200</sub> or buffer rooms 2 x EI<sub>2</sub>45-C3S<sub>200</sub> (EI<sub>2</sub>60-C3S<sub>200</sub> or buffer rooms 2 x EI<sub>2</sub>30-C3S<sub>200</sub>)<sup>#</sup></i>	<i>EI<sub>2</sub>120-C3S<sub>200</sub> or buffer rooms 2 x EI<sub>2</sub>60-C3S<sub>200</sub> (EI<sub>2</sub>90-C3S<sub>200</sub> or buffer rooms 2 x EI<sub>2</sub>45-C3S<sub>200</sub>)<sup>#</sup></i>
II	Walls	<i>EI/REI 45 (30)<sup>#</sup></i>	<i>EI/REI 90 (60)<sup>#</sup></i>	<i>EI/REI 120 (90)<sup>#</sup></i>	<i>EI/REI 180</i>
	Floors	**	**	<i>REI 90</i>	<i>REI 120</i>
	Doors	<i>EI<sub>2</sub>20-C3S<sub>200</sub> (S)<sub>2</sub>15-C3S<sub>200</sub>)<sup>#</sup></i>	<i>EI<sub>2</sub>45-C3S<sub>200</sub> (S)<sub>2</sub>30-C3S<sub>200</sub>)<sup>#</sup></i>	<i>EI or buffer rooms, <sub>2</sub>60-C3S<sub>200</sub> 2 x EI<sub>2</sub>30-C3S<sub>200</sub> (EI or buffer rooms <sub>2</sub>45-C3S<sub>200</sub> 2 x EI<sub>2</sub>20-C3S<sub>200</sub>)<sup>#</sup></i>	<i>EI or buffer rooms <sub>2</sub>90-C3S<sub>200</sub> 2 x EI<sub>2</sub>45-C3S<sub>200</sub></i>
III	Walls	<i>EI/REI 30</i>	<i>EI/REI 60 (45)<sup>#</sup></i>	<i>EI/REI 90 (60)<sup>#</sup></i>	<i>EI/REI 120</i>
	Floors	**	**	<i>REI 60</i>	<i>REI 90</i>
	Doors	<i>EI<sub>2</sub>15-C3S<sub>200</sub> (EI<sub>2</sub>20-C3S<sub>200</sub>)<sup>#</sup></i>	<i>EI<sub>2</sub>30-C3S<sub>200</sub> (EI<sub>2</sub>20-C3S<sub>200</sub>)<sup>#</sup></i>	<i>EI<sub>2</sub>45-C3S<sub>200</sub> (EI<sub>2</sub>30-C3S<sub>200</sub>)<sup>#</sup></i>	<i>EI<sub>2</sub>60-C3S<sub>200</sub></i>
IV	Walls	<i>EI/REI 15</i>	<i>EI/REI 45</i>	<i>EI/REI 60</i>	<i>EI/REI 90</i>
	Floors	**	<i>REI 30</i>	<i>REI 45</i>	<i>REI 60</i>
	Doors	<i>C3S<sub>200</sub></i>	<i>EI<sub>2</sub>20-C3S<sub>200</sub></i>	<i>EI<sub>2</sub>30-C3S<sub>200</sub></i>	<i>EI<sub>2</sub>45-C3S<sub>200</sub></i>
V	Walls	<i>EI/REI 15</i>	<i>EI/REI 30</i>	<i>EI/REI 45</i>	<i>EI/REI 90</i>
	Floors	**	<i>REI 15</i>	<i>REI 30</i>	<i>REI 60</i>
	Doors	<i>C3</i>	<i>EI<sub>2</sub>15-C3S<sub>200</sub></i>	<i>EI<sub>2</sub>20-C3S<sub>200</sub></i>	<i>EI<sub>2</sub>45-C3S<sub>200</sub></i>

Notes:

\* – it does not refer to high or very high buildings

\*\* – according to fire stability floor classification

# – the values in brackets shall apply in cases where the rooms are equipped with automatic fire-fighting systems.

(2) Storage rooms for combustible products and substances with useful area less than or equal to 36 m<sup>2</sup> located in civilian buildings shall be separated from the rest of the building by walls and floors A1 or A2-s1d0 according to the provisions of Table 22, regardless of the density of the heat load.

Table 22: Minimum conditions for separation of storage rooms ≤ 36 m<sup>2</sup> of civil buildings

Lev. stab.	Construction elements	Fire resistance	
		buildings equipped with extinguishing installations	buildings not equipped with extinguishing installations
I	Walls	<i>EI/REI 90</i>	<i>EI/REI 120</i>
	Floors	<i>REI 90</i>	<i>REI 120</i>
	Doors	<i>EI<sub>2</sub>45 (except those in residential buildings)</i>	<i>EI<sub>2</sub>60 (except those in residential buildings)</i>
II	Walls	<i>EI/REI 60</i>	<i>EI/REI 90</i>
	Floors	<i>REI 60</i>	<i>REI 90</i>
	Doors	<i>EI<sub>2</sub>30 (except those in residential buildings)</i>	<i>EI<sub>2</sub>45 (except those in residential buildings)</i>
III	Walls	<i>EI/REI 45</i>	<i>EI/REI 60</i>
	Floors	<i>REI 45</i>	<i>REI 60</i>
	Doors	<i>EI<sub>2</sub>20 (except those in residential buildings)</i>	<i>EI<sub>2</sub>30 (except those in residential buildings)</i>

Lev. stab.	Construction elements	Fire resistance	
		<i>buildings equipped with extinguishing installations</i>	<i>buildings not equipped with extinguishing installations</i>
		<i>buildings</i> )	<i>buildings</i> )
IV	<b>Walls</b>	<b>EI/REI 30</b>	<b>EI/REI 30</b>
	<b>Floors</b>	<b>REI 30</b>	<b>REI 30</b>
	<b>Doors</b>	<b>EI<sub>2</sub>15</b> (except in residential buildings)	<b>EI<sub>2</sub>20</b> (except in residential buildings)

(3) Storage rooms in civil buildings with useful area larger than **36 m<sup>2</sup>** and thermal load greater than **105 MJ/m<sup>2</sup>** fire systems shall be provided with smoke and hot gas exhaust systems by organised natural draught or by mechanical ventilation, according to the provisions of the Rule and the specific technical regulations. The total useful/aerodynamic area of the free area of devices with automatic smoke discharge aperture in the event of organised natural fire, shall be at least **1 %** of the surface of the floor coverings. When smoke exhaust is provided by mechanical ventilation, the provisions of the Rule and/or technical regulations shall be complied with.

**Article 2.4.16.3. (1)** In manufacturing constructions, storage rooms for combustible materials and substances with a larger useful area of **36 m<sup>2</sup>** shall be compulsorily separated from the rest of the construction by construction elements with fire resistance conforming to the provisions **Article 2.3.1.2** and Table 5 but not less than:

- a) **EI/REI 180** for walls and at least **REI 120** for floors, when rooms have a high or very high fire risk and communication gaps with the rest of the construction are protected with fire resistant and smoke tight doors as a minimum **EI<sub>2</sub>90-C3S<sub>200</sub>**;
- b) **EI/REI 120** for walls and at least **REI 90** for floors, when rooms have a medium fire risk and communication gaps with the rest of the construction shall be protected with fire resistant and smoke tight doors as a minimum **EI<sub>2</sub>60-C3S<sub>200</sub>**;
- c) **EI/REI 30** for walls and at least **REI 30** for floors, when rooms have a low fire risk and communication gaps with the rest of the construction shall be protected with fire resistant and smoke tight doors of minimum **EI<sub>2</sub>15-C3S<sub>200</sub>**.

(2) Storage rooms presenting a volumetric explosion risk/hazard shall be provided as far as possible in separate parts of the construction (it is recommended to take place at the last above-ground level of the construction), according to the provisions on common and specific performance and with the provision of appropriate protective measures.

(3) Walls and floors separating storage rooms, technical rooms, technical and social attachments, laboratories and workshops attached to rooms with very high fire risks shall resist fire depending on the density of the heat load (**q**) and, where applicable, at volumetric explosion, and the strictly functional communication gaps in the walls shall be provided with protected buffer rooms, ventilated over pressure and provided with fire resistant and smoke tight doors **EI<sub>2</sub>90-C3S<sub>200</sub>**.

(4) Storage rooms with a useful area larger than **36 m<sup>2</sup>** and thermal load greater than **105 MJ/m<sup>2</sup>** shall be provided with smoke and hot gas exhaust systems by organised natural draught or by mechanical ventilation, according to the Rule and specific technical regulations. The total useful/aerodynamic area of the free area of devices with automatic smoke discharge aperture in the event of organised natural fire, shall be at least **1 %** of the surface of the floor coverings. When fuming is provided by mechanical ventilation, the provisions of the Rule and/or technical regulations shall be complied with.

**Article 2.4.16.4.** Fire safety conditions and measures laid down in the general provisions of the Rule, the common and specific performance and those laid down in the applicable specific technical regulations shall be ensured in storage construction.

**Article 2.4.16.5. (1)** Provision in the construction of a room to store a maximum of **10 m<sup>3</sup>** combustible liquids or maximum **20 m<sup>3</sup>** solid fuel necessary for the functional consumption of the related utility installations, power plant, hot air heating plant, etc.) as well as hydraulic equipment (lifts, platforms, lifts, etc.), if provided:

**a)** separation of the room from the rest of the construction by minimum fire resistant walls **EI/REI 120** and minimum fire-resistant floors **REI 120**, reaction class to fire **A1** or **A2-s1d0**;

**b)** direct outside access protected by fire resistant and smoke tight fastening element **EI<sub>2</sub>45-C3S<sub>200</sub>** or by a gap in separating elements from the rest of the construction, protected by buffer rooms ventilated under excess pressure provided with fire resistant and smoke tight doors **EI<sub>2</sub>30-C3S<sub>200</sub>**. In both cases, access gaps shall be provided with watertight bulkheads or thresholds of such height that in the event of damage it is not possible to leak the fuel fluid out of the storage room;

**c)** provision of fuel liquid tanks with a discharge pipe and a ventilation pipe with flame stopper, arranged outside the construction.

**(2)** In these rooms it is not mandatory to provide decompression panels and exhaust devices for smoke and hot gases in the event of fire.

**(3)** In civilian buildings which are not high and very high, as well as in production and/or storage, it is permissible to store maximum **10 m<sup>3</sup>** liquid fuel required for use in the building's thermal power station (light liquid fuel, gas oil, fuel oil). Storage shall be carried out in rooms separated from the rest of the building by walls, doors and floors constructed according to the standardised provisions. Thresholds shall be laid down to avoid spreading overflowing liquids in the event of damage, ensuring rapid emptying and signalling and fire-fighting installations. These rooms shall not include devices for exhaust of smoke and hot gases in the event of fire nor cleaning panels (decompression for explosion).

**Article 2.4.16.6. (1)** In the room of the thermal power station in any building, a daytime tank for liquid fuel necessary for combustion may be placed, with a capacity not exceeding **2 m<sup>3</sup>**, mounted on the side of the boilers at a distance of at least **2.50 m** from the injectors and not above boilers or in the direction of any misfire or flue gas outlet at the opening of the explosion dampers.

**(2)** In addition to the day tank or the one admitted in **Article 2.4.16.5.** for civil buildings of normal height, other stocks of liquid fuel located in the thermal power station shall not be permitted.

**Article 2.4.16.7. (1)** In the room of the thermal power station operating with solid fuels, a day bunker for solid fuel can be placed, with the maximum capacity of **2 m<sup>3</sup>**.

**(2)** Solid fuel bunkers of a capacity of **2 m<sup>3</sup>** and fuel funnels to combustion plants related to thermal power stations must be made of materials of the reaction to fire class **A1** or **A2-s1d0**.

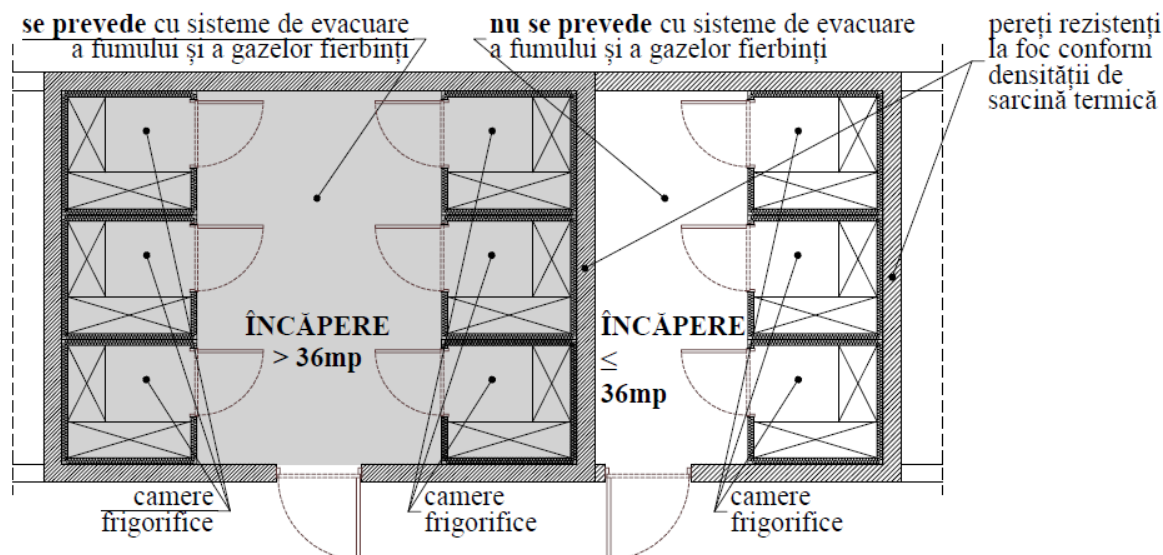
**Article 2.4.16.8. (1)** Solid fuel bunkers with a capacity greater than **2 m<sup>3</sup>** shall be separated from the rest of the construction by walls and floors the reaction to fire class **A1** or **A2-s1d0** with fire resistance corresponding to the provisions of **Article 2.4.16.5**, and communication gaps with the rest of the construction shall be protected by closing elements according to the provisions of the same Article and shall have a capacity corresponding to the consumption for one exchange, for each boiler unit.

**(2)** For coal-fired power plants, it is recommended that the fuel supply to the boilers, as well as the ash removal, be done mechanically. In slag and ash deposits with a capacity above **50 m<sup>3</sup>** provision shall be made for fixed water extinguishing systems (hydrants).



**Article 2.4.16.9. (1)** Box-in-box refrigeration rooms shall not be considered as storage rooms, and under these conditions it shall be provided with smoke and hot gas exhaust systems in the room in which the cold rooms are located, according to the provisions of the Rule.

**(3)** Building rooms in which cold rooms with a useful area larger than **36 m<sup>2</sup>** and heat load above **105 MJ/m<sup>2</sup>** are located shall be provided with systems for the exhaust of smoke and hot gases by organised natural draught or by mechanical ventilation, according to the provisions of the Rule and the specific technical regulations *according to Figure 53*). The total useful/aerodynamic area of the free area of devices with automatic smoke discharge aperture in the event of organised natural fire, shall be at least **1 %** of the surface of the floor coverings. When smoke exhaust is provided by mechanical ventilation, the provisions of the Rule and/or technical regulations shall be complied with.



se prevede cu sisteme de evacuare a fumului și a gazelor fierbinți	foreseen with smoke and hot gas exhaust systems
nu se prevede cu sisteme de evacuare a fumului și a gazelor fierbinți	not foreseen with smoke and hot gas exhaust systems
pereți rezistenți la foc conform densității de sarcină termică	fire-resistant walls according to thermal load density
<b>ÎNCĂPERE &gt; 36mp</b>	<b>ROOM &gt; 36mp</b>
camere frigorifice	refrigeration rooms

**Figure 53 - Box-in-box refrigeration rooms**

**Notes (Figure 54):**

Cold rooms shall be provided with fire resistant walls according to the density of the heat load, according to **Article 2.3.1.2. and Table 5**

For cold store buildings, consideration shall be given to **Article 6.1.4.6. and Article 6.1.4.7.**

**(3)** Equipment with detection, signalling, alarm and automatic fire extinguishing facilities shall be provided both for the space in which the rooms are located and in refrigeration rooms, taking into account the characteristics of the compartment/building in which they are located.

## **2.4.17. Billboard commercials placed on the facades of buildings**

**Article 2.4.17.1. (1)** Billboards commercials may be placed on the facades of construction or their terraces, which shall be tested as a finished product, design and perform according to the provisions of the specific regulations, if they meet the legal requirements concerning the location and authorisation of advertising facilities and the specific fire safety measures so that they do not initiate fires.

(2) It is forbidden to arrange illuminated billboards above the outdoor escape exists of building users, the minimum distance of the location of the illuminating panels from any opening in the facade shall be at least **1 m**.

(3) Electrical installations shall be designed according to specialist regulations.

## **2.4.18. Facilities and equipment using renewable energy sources**

**Article 2.4.18.1. (1)** Solar heating systems may be used to heat water.

(2) Solar water heating systems can be supplied with electricity from the national system, generating sets or renewable sources (photovoltaic panels or cells, wind micro-turbines, etc.) located independently at standardised distances or on construction.

(3) In order to limit the spread of fire and not affect the performance of the building, when solar water heating systems (solar sinks) are located on construction, measures shall be taken to delineate the spread of fire through existing (technologically necessary) voids in the roof or walls.

**Article 2.4.18.2.** The provisions of specialised regulations shall apply to electrical devices for the supply of 'solar photovoltaic energy, including alternating current modules, on the roof of buildings, as well as those constituting a protective and/or finishing component on the facades.

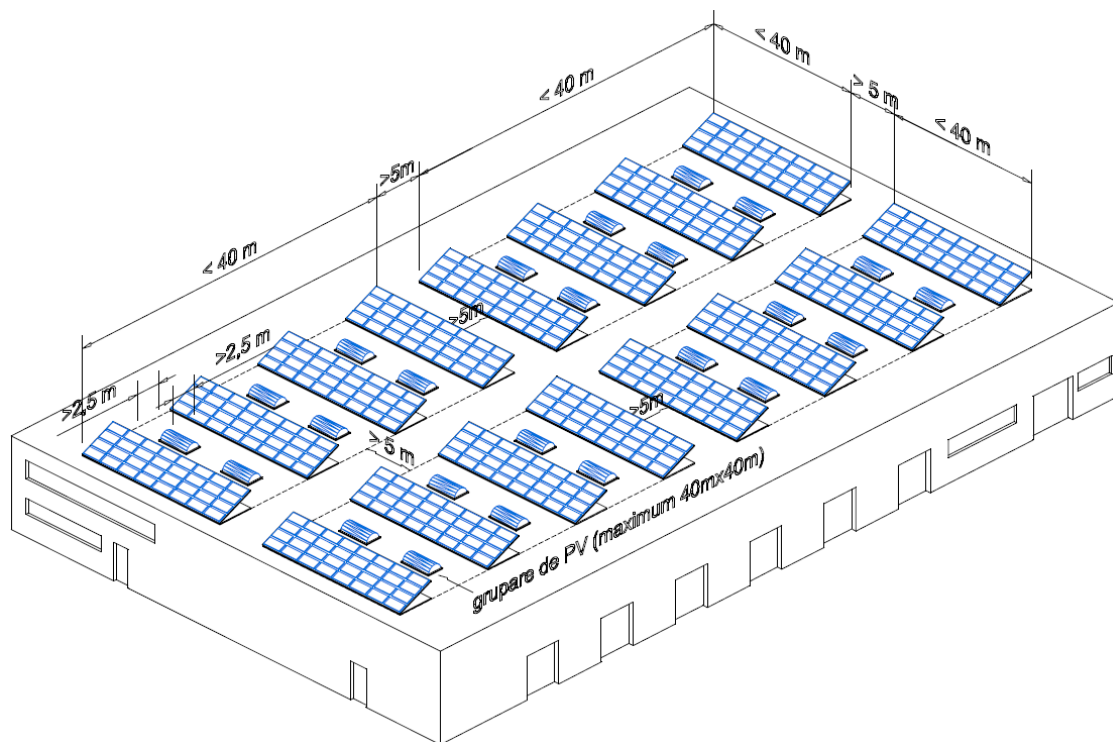
**Article 2.4.18.3.** The degree of protection for roof coverings depends on their compliance and the distance to the contour. Photovoltaic devices (cells, modules, single-type panels, etc.) located on the roof shall be regarded as components of the roof and as such shall withstand the ignition and/or propagation of fire from an external source.

**Article 2.4.18.4.** The main requirements for the siting of photovoltaic panels on individual residential buildings with one or two levels are:

- a)** for each roof slope with more than two waters a minimum clearance shall be provided **1 m** from external load-bearing walls, minimum **1 m** from the coping of the roof and minimum **50 cm** on each side of a roof valley or a skylight;
- b)** for each roof gradient on which photovoltaic modules are placed, two access spaces of minimum **1 m** width shall be provided and at least **1 m** from the coping of the roof.

**Article 2.4.18.5.** In residential buildings with three or more above-ground levels, as well as other civil, production and storage functions, the installation of photovoltaic panels shall ensure the installation of photovoltaic panels (*Figure 54*):

- a)** a free perimeter of at least **1 m** width around the edges of the roof;
- b)** minimum distance of **2.5 m** around skylights, ventilation or exhaust hatches for smoke and hot gases in the event of fire, and other roof penetrations;
- c)** minimum distance of **4.00 m** from the fire resistant bulkheads separating fire compartments (fire bulkheads);
- d)** the continuity of the PV network must be interrupted at least against the compaction-expansion or seismic joints of the construction so as to limit the propagation of combustion; the interruption of continuity shall be achieved by continuous strips from a minimum distance of **1 m** in relation to the joint. On the width of minimum **1 m** from the joint, materials with reaction to fire class **A1** or **A2-s1d0**, shall be used or protective measures shall be provided for the fuel components of roofs over the normal width of the cut-off strip.
- e)** Groups of photovoltaic cells shall have a maximum area of **40 m x 40 m**; they shall be located to a minimum **5 m** away from other groupings;



grupare de PV (maximum 40m x 40m)	PV grouping (maximum 40 m x 40 m)
-----------------------------------	-----------------------------------

**Figure 54 - Location of photovoltaic cell groupings**

**Article 2.4.18.6.** In constructions on which photovoltaic systems/devices are located, it is recommended to fulfil the safety conditions of the intervention teams ensuring:

- a) access and escape to/from the roof (roof framing or terrace);
- b) easy access routes to roof areas;
- c) distinctive and visible marking and labelling of the entire photovoltaic system; (general switchgear – to be located in an accessible area of the building, all ducts, cables, inverters, boards and boxes of the AC current circuit, as well as batteries and accumulators), with reflective, weatherproof and recyclable materials;
- d) provision of a load breaker, easily operable;
- e) equipping the photovoltaic system with an arching detection device.

**Article 2.4.18.7.** Fires in photovoltaic devices (cells, modules, single-type panels, etc.) independently located or placed on the roof or on perimeter closures of buildings shall be treated by intervention teams (firefighters) as fires in electrical equipment.

**Article 2.4.18.8. (1)** Facades and roofing on which photovoltaic devices are applied shall have:

- a) thermal insulation of the non-combustible facade, regardless of the destination and/or rise of the building;
- b) non-combustible anchorages and assemblies, regardless of the destination and/or rise of the building;
- c) linkages of equipotential bonding and grounding, according to specialist regulations.
- d) on the roof, the layer to which it is applied:
  - must achieve the external fire performance set out in Table 2 and Table 3 for refrigerator systems (Panels/systems for slope roof coverings with additional charges from photovoltaic devices)
  - or
  - in the case of the arrangement of photovoltaic panels over a terrace

floor, the external component layer of roofs intended to ensure that the construction is weathertight (mostly waterproofing) shall meet the external fire performance specified in Table 2 and Table 3 for covering systems (Panels/systems of slope roofs with additional photovoltaic loads) according to the fire stability level of the construction;

e) on the façades, the layer to which it is applied must meet the minimum burning performance **EI 30**

(2) When photovoltaic panels are integrated into curtain walls or exterior joinery systems (being a functional part of the building envelope), the provisions of **Article 2.4.18.8 (1) (a), (b) and (c)** shall apply and one of the following measures may be taken:

a) between photovoltaic panels that are integrated into the curtain wall or external joinery systems at each level to delay the propagation of fires between construction levels outside the perimeter closure (on the facades), one of the measures listed at **Article 2.3.6.1.2.** shall be provided

b) Curtains (fire resistant) **EI** or fire tight **E** fitted with sprinkler assembly) shall be provided, with the same strength as the element intended to delay the propagation of fire between construction levels outside the perimeter closure (same strength as the elements prescribed in **Article 2.3.6.1.2. ÷ Article 2.3.6.1.6.** for the different types, heights and uses of buildings)

c) active fire-fighting systems (water curtain) located inside the building at a maximum distance of **30 cm** from the perimeter closure shall be provided.

**Article 2.4.18.9.** Technical rooms for photovoltaic panel equipment shall be provided with walls and floors of minimum **REI180**, respectively **REI 90** reaction class to fire **A1** and communication gaps in bulkheads shall be provided with fire resistant and smoke tight doors **EI<sub>2</sub>90-C3S<sub>200</sub>** They shall be provided with ventilation according to specialised standards.

**Article 2.4.18.10.** Photovoltaic devices (cells, modules, single-type panels) placed on the roofs or facades of construction shall be suitable for this use.

#### ***2.4.19. Conformations, installations and equipment specific to accumulators batteries***

**Article 2.4.19.1.** Electric accumulators may be classified in the following categories depending on the release of gases from the electrolysis process:

- open or closed with a valve,
- sealed with a valve (acidic watertight accumulators/VRLA), with electrolyte fixed in gel or in plate separators;
- closed with a minimum 95 % valve/recombination system (alkaline and acid batteries),
- hermetically sealed (alkaline batteries)

**Article 2.4.19.2. (1)** Accumulator batteries shall be installed in dedicated battery rooms.

(2) Individual accumulators and accumulator batteries, sealed (hermetically sealed), may be installed in rooms and production sites classified as low and medium fire risk.

(3) Batteries with closed-type elements (closed with valve/recombination system min. **95 %**) may also be installed in production rooms and facilities, except those of high and very high risk , if:

- loading shall not take place in the room in which they are located<
- the elements are mounted in a box (cabinet) resistant to electrolyte vapour, which allows the removal of accidentally drained electrolyte from accumulators, and the box (cabinet) has ventilation channels (inlet and outlet) towards the outside and there is ventilation of the room with a set flow rate (according to **SR EN IEC 62485-2**), and the battery charge is done without exceeding the gas discharge voltage;

– maximum charging power shall not exceed the maximum values that are given by the manufacturer for a new battery and charging at **100 %** capacity for lead-acid and alkaline accumulators, the room shall be well ventilated and the free volume shall be at least **2.5 times** higher than the hourly air flow rate that would be required for ventilation (according to **SR EN IEC 62485-2**). If the free volume is smaller, appropriate natural, organised or forced ventilation must be installed.

**Article 2.4.19.3. (1)** Several accumulator batteries of the same type (acid and alkaline) may be installed in the same chamber.

**(2)** It is prohibited to temporarily or permanently mount sulphuric acid batteries and potassium hydroxide accumulators in shared rooms or with common ventilation, except in the case of watertight elements accumulator batteries.

**(3)** Accumulators shall typically be provided on a single level (as indicated on the ground floor), mounted on the floor and/or on posts (sockets) or provided that their stability is ensured, depending on the seismic areas in which the construction is placed in such a way as to ensure seismic resistance.

**(4)** In the room for accumulators batteries, they shall be placed in strings, spacing between each other and from the walls. There must be a minimum clearance of **50 mm** between the strings and walls for air circulation and for each block of accumulators fitted, there shall be an access path on at least one side. The clear width of access movements shall be at least **1.5 times** battery depth, but not less than **1 flow (80 cm)** where they are located on one side and a minimum **1 m** (advisable **1.20 m**) when located on both sides with the provision of windows at the ends of the paths. Lighting fixtures shall be positioned at a distance from accumulators of at least **1 m** and shall only be placed above paths between accumulators strings.

**(5)** In the room of accumulator batteries, the location of live elements and conductors shall be such that a person cannot simultaneously reach two uninsulated live parts (e.g. providing for a greater distance between parts of **1.80 m** or whether protective measures are taken in the event of direct interference).

**(6)** In the immediate vicinity of the battery, the safety distance within which spark or incandescent devices are prohibited (maximum surface temperature **300° C**) shall be observed, calculated according to **SR EN IEC 62485-2**.

**(7)** Relative humidity in the room of battery accumulators shall not exceed **90 %**, without condensation.

**Article 2.4.19.4. (1)** Storage facilities for lithium-ion batteries protected with automatic sprinkler extinguishing system according to standard **SR EN 12845** must comply with the following:

- the storage area must be limited to maximum **20 m<sup>2</sup>**
- the storage height must be limited to **1.80 m**
- storage areas must be separated by corridors of at least **3.00 m** width.
- a battery state of charge shall be maintained  $\leq$  **60 %**

**(2)** Storage facilities for lithium-ion batteries protected with automatic rapid response sprinkler extinguishing facility (according to standards **SR EN 12845** and **SR EN 12259-13** or equivalent regulation) must meet the following:

- the storage area must be limited to maximum **20 m<sup>2</sup>**
- the storage height must be limited to three height levels (maximum **4,50 m** height in shelves or pallets), other goods not allowed to be stored above them;
- storage areas must have the maximum height of **12 m**

**(3)** For the storage of lithium-ion batteries in constructions not fitted with automatic sprinkler facilities, the following shall be fulfilled:

- the storage rooms/constructions are intended for special use only for that purpose;
- containers or enclosures located outdoors shall be non-combustible and positioned at least **6 m** away from other equipment, buildings, structures and warehouses (if specific

provisions do not recommend longer distance).

(5) For all lithium-ion battery storage rooms and compartments, smoke detection systems (smoke detection and carbon monoxide (CO)) shall be provided, including (advisable) according to the profile standard, flood extinguishing systems.

(6) Smoke exhaust systems shall be provided for all lithium-ion battery storage rooms and compartments.

**Article 2.4.19.5. (1)** Compliance of chambers and/or spaces for storage and loading of accumulators shall be done in the sense of preventing the formation of an explosive concentration of hydrogen (the mixture of hydrogen in the air is explosive if it contains between 4 % and 75 % hydrogen, in volumes), as follows:

- a. walls and floors shall be minimum **REI180** reaction class to fire **A1** and strictly functional communication gaps in walls shall be provided with protected buffer rooms, ventilated in over pressure and provided with fire resistant and smoke tight doors **EI**, being forbidden to protect it by different means, except for those which communicate with rooms of the same function (storage), where fire resistant and smoke tight doors are provided **EI<sub>2</sub>90-C4S<sub>200</sub>**, as well as for the situations set out in **Article 2.4.19.6.**
- b. the cell rooms must be ventilated, regardless of whether the batteries are charging, discharging or idle.
- c. the passage through walls by ducts, conductors or electric cables is prohibited, except in the case of electric cables serving the actual installations of such rooms; cable installations or electric cable beds serving the installations themselves located above accumulators are recommended not to pass over the batteries; the electrical installation in the chamber is operated according to the installation standards (from **SR HD 60364-1, SR HD 60364-4 to SR HD 60364-7**);
- d. the surface wear layer of the floor coverings shall be made of materials that do not cause flames to ignite the explosive mixtures in question at its impact;
- e. the floor coverings shall be designed in such a way as to take over the task of the battery, including future extensions; for batteries with a liquid electrolyte, the floor must be impermeable and chemically resistant to the action of the electrolyte or the battery cells/blocks shall be mounted in racks that collect localised accidental spillages of electrolyte; in the case of installing accumulator batteries consisting of sealed elements, in which, in the event of breaking the vessels, electrolyte cannot leak (for example, elements with the electrolyte immobilized in gel), it is not necessary for the floor layer and the pedestals to be electrolyte resistant.
- f. the floor coverings shall be flat and capable of supporting the weight of the batteries; if they are to be placed in racks providing local collection of accidental electrolyte leaks, they shall be provided with an elevated liquid tight threshold with a minimum height of 10 cm to prevent the flow of liquids into adjacent areas; where liquid tight thresholds are provided, they may be omitted at door openings by the installation of an open grill which is connected to an authorised drainage channel system for discharge; in this case, a standardised method of neutralising the discharged electrolyte shall be considered;
- g. joinery and its intervention systems shall meet the requirements of the ATEX Directive
- h. shall have no suspended or self-supporting ceilings and non-ventilated areas that facilitate the production of dangerous air concentrations with combustible gases, vapours or dust.
- i. it is forbidden to be placed under wet rooms (baths, washers, WCs, water pumps, etc.).
- j. the free height of the accumulator chamber shall be at least **2.10 m** provided that it is equal to the minimum height indicated by the supplier of the accumulators (if higher) and must exceed by at least **75 cm** the maximum height of the battery fitted to the postage (or higher, as indicated in the product fiches).

- k. the walls, floors and floors of accumulator chambers shall be moisture resistant and electrolyte if batteries of non-watertight accumulators are installed.
- l. windows of accumulator chambers shall be protected externally by small mesh metal grill or netting or be of reinforced glass and may have matured or low-E glass panes.
- m. the doors of accumulator chambers and buffer rooms ventilated in excess pressure shall open outwards and shall be equipped with panic handles or bars;

(2) Battery storage facilities in constructions with other operation shall be separated from other areas by a construction with minimum fire and explosion resistant walls and floors **REI180** reaction class to fire **A1** and strictly functional communication gaps in walls shall be provided with protected buffer rooms, ventilated over pressure and provided with fire resistant and smoke tight doors **EI<sub>290</sub>-C3S<sub>200</sub>**, being forbidden to protect by different means, except for those which communicate with rooms of the same function (storage), where fire resistant and smoke tight doors are provided **EI<sub>290</sub>-C4S<sub>200</sub>**, as well as for the situations set out in **Article 2.4.19.6**.

**Article 2.4.19.6.** Direct access to the storage room, without the ventilated buffer room in excess pressure, is permitted if:

- access is made from outside, in this situation, measures shall be taken to prevent rain water and snow entering the storage chamber (e.g. by providing an external cover or by withdrawing entry from the line of the external walls);
- when the secondary cells are closed type with recombination, and access is via a connecting space or via a corridor in which there are no technological installations and which is not a permanent working area;
- accumulator batteries shall be watertight.

**Article 2.4.19.7. (1)** In order to eliminate the explosion hazard by diluting the hydrogen mixture in air and by diluting and evacuating electrolyte release to air in order to reduce the degree of aggression, accumulator chambers must be ventilated (e.g.: Whether sealed or not, all lead-acid batteries can emit explosive gases – especially during charging – so adequate ventilation is mandatory, the gaseous hydrogen emitted during charging is explosive). When emitted to the surrounding atmosphere, an explosive mixture may be created if the hydrogen concentration exceeds **4 %** volume of hydrogen in air.

(2) For the purpose of diluting the gases (hydrogen and oxygen) generated during the charging and discharging – and thus eliminate the risk of explosion – the rooms of batteries shall be ventilated according to the standard **SR EN IEC 62485-2** (for more information see annex). The ventilation system shall be designed to cope with wet room conditions. The purpose of ventilation of a site (**UPS**) or battery housing is to keep the hydrogen concentration below **4 %** vol. – lower explosion limit threshold (**LEL**) of hydrogen. Battery rooms and enclosures shall be considered explosion-protected when by natural or forced (artificial, mechanical) ventilation, the hydrogen concentration is kept below this safety limit (**LEL**).

(3) The minimum airflow rate for ventilation of the battery space or enclosure shall be calculated according to standard **SR EN IEC 62485-2**.

(4) The maximum charge power shall not exceed the maximum permissible values that are given by the manufacturer for a new battery and charging at **100 %** capacity for lead-acid and alkaline accumulators, the room must be well ventilated and the free volume must be at least **2.5 times** higher than the hourly air flow that would be required for ventilation (the introduction and exhaust of air may be on the same part of the room). If the free volume is smaller, appropriate natural, organised or forced ventilation must be installed.

## SECTION V

### 2.5. Escape routes for users in case of fire

#### 2.5.1. General provisions

**Article 2.5.1.1.** The provisions of the Rule are conditions to be complied with when designing and implementing the escape routes for users of buildings for any purpose, in order to protect the life, integrity and property of users, as a priority objective of fire safety.

**Article 2.5.1.2. (1)** In constructions, fire compartments and rooms shall be provided for escape routes for users, through which, in the event of a fire, they can reach outside the building, at the level of terrain or road surfaces, over the foreseeable distance and under safe conditions. For persons who cannot evacuate themselves (defined according to terminology: children of pre-school age, old age, sick or disabled persons), assisted escape conditions shall be provided, according to the relevant provisions of the Rule and profile regulations.

**(2)** Under the conditions and over the standard escape distance, the undisturbed air quality of the users' escape routes shall be ensured by the conjugated effect of fire stability measures, limiting the spread of fires and, where applicable, smoke exhaust measures in the event of fire.

**(3)** For functional movements of no more than 5 level users in ordinary civilian buildings and functional paths of places/rooms where the presence of users occurs by chance or are visited by no more than **8 times per exchange** (for control or verification purposes) and in all cases where at each level of production and/or storage construction no more than one may be present at the same time **10** users shall not be required to fulfil the prescribed standard length conditions.

**Article 2.5.1.3. (1)** Functional movements which meet the conditions for the layout, composition and implementation laid down in the legislation and ensure exit conditions for the users of the building (via doors, corridors, protected clearance, halls, changing rooms, tunnels, staircases, terraces, passageways, etc.), on the ground or external road surfaces or in safe places inside the building, are escape routes for users.

**(2)** The traffic routes provided for the normal operation of buildings shall be so arranged, constructed and constructed as to ensure adequate escape conditions for users in the event of fire. Routes specially designed for the escape of users in the event of fire shall be provided only when the functional ones are insufficient or do not satisfy the standard fire safety requirements.

**(3)** It may also be used for escape and passage through adjacent rooms or spaces through which it is possible to circulate, provided that the standard escape length in one direction (capped corridor) is respected or if such crossings are not the only route of escape of users.

**Article 2.5.1.4. (1)** The following shall not be considered as escape routes in the event of fire:

**a)** lifts other than those used for assisted evacuation, sliding doors, non-automatic or non-automatic sliding doors and normal opening (on hinges or pivots), guillotine doors, doors which can lock in a closed position due to the action of fire, curtains which do not allow users to pass, passages for trainsets carrying dangerous loads (passageways), galleries and tunnels through which substances of fire, explosion, intoxication, asphyxiation or higher pressure steam are carried or transported **1** bar;

**b)** movements on roofs and on terraces which have not secured and marked safe escape routes up to ground level and whose floor does not meet the standard condition.

**(2)** Doors locked during normal operation of the construction may be the second escape route of the users of a building section or of the whole building, if their composition and dimensioning are according to the provisions of the standard and which can be unlocked by the



output devices (mechanically operated anti-panic exit devices or mechanically operated emergency exit devices). Doors which are closed by electromagnetic systems must also be operable from the evacuating area (as well as automatically from the signalling centre).

(3) Escape doors closed by electromagnetic systems or devices or magnetic contacts included in incubation (doors with control access) may be constructed in such a way that they can be opened locally (by actuating a button located near the door, in a gap box that can break) and centralised from the fire safety dispatcher (in buildings where they exist) and automatically via the fire signalling centre in the event of fire.

(4) For less than 5 users, where sliding doors, sectional, trap-doors, etc. are used, they shall complete the following: the free dimensions of the trap-doors must be minimum **80 cm x 80 cm** with manual opening devices (not capable of locking) provided on both sides of it, steel stairways made according to specific rules; sectional doors/gates with steel sliding systems which are manually controlled in case of power cuts, sliding doors with metal sliding systems, etc.

**Article 2.5.1.5.** The use of draperies, curtains, curtains, drop curtains, etc., which may interrupt escape routes, is prohibited. No false doors or mirror cladding shall be permitted on escape routes, with the exception of sanitary facilities, in which mirrors may be provided.

**Article 2.5.1.6.** The technical design documentation of the constructions shall be marked with the routes of the users' escape routes.

## **2.5.2. Arrangement, composition, finishing**

**Article 2.5.2.1. (1)** The layout, composition, finishes and number of escape routes of building users shall be designed and carried out according to the provisions of this Rule in such a way as to meet the performance appropriate to the type of construction, purpose, fire risk and the level of fire stability provided.

(2) The escape routes of users of underground public spaces must be independent of those of the above-ground levels with another destination, and communication between them is permitted only under the conditions laid down in the Rule.

(3) Functional traffic and escape routes of users of underground levels with maximum simultaneous capacity greater than **500** level users or underground rooms with maximum simultaneous capacity greater than **150** users (except parking), shall be independent of the escape routes of the overground levels with another destination, and communication between them is permitted only through protected buffer rooms.

(4) The storage or layout of furniture shall not be permitted on escape routes.

(5) By way of exception to paragraph 4, on the common horizontal escape routes (corridors, halls), it is permissible to provide:

a. fixed furniture elements made of non-combustible materials, in compliance with the minimum gauges required for escape resulting from the calculation or specific provisions;

b. fixed furniture elements made of combustible materials when complying with the specified reaction to fire classes in relation to the fire stability levels of the construction, provided that the heat input of such furniture does not result in a density of the heat load greater than **105 MJ/m<sup>2</sup>** within the enclosure of the space in which they are located and with the obligation to place them exclusively in corridors or halls (including lobbies) ventilated under excess pressure or with mechanical intake and mechanical smoke discharge.

(6) Furnishing articles made of combustible materials specified in **paragraph 5(b)** may be used in relation to fire stability levels as follows:

– minimum reaction to fire class **D-s2d0** or whose finishes meet the minimum fire performance criteria **K<sub>2</sub>10** (on level **IV** and **V** of fire stability);

- minimum reaction to fire class **C-s2d0** or whose finishes meet the minimum fire performance criteria **K<sub>2</sub>30** (on level **III** of fire stability);
- minimum reaction to fire class **B-s1d0** or whose finishes meet the minimum fire performance criteria **K<sub>2</sub>60** (on level **II** of fire stability).
- not admitted (on level **I** of fire stability).

(7) It shall not be permitted to place any furniture (combustible or non-combustible) within the enclosure of escape stairways, protected clearance, buffer rooms, escape tunnels, open drums.

**Article 2.5.2.2. (1)** The routes of the escape routes of users of a building on which a minimum of two escape routes are required in the event of fire shall be distinct and independent, so arranged and constructed as to ensure their judicious distribution, easy recognition of the outward route and the circulation of users.

(2) Users escape routes shall be provided in appropriate numbers and shall lead towards the outside of the construction through spaces in which traffic cannot be blocked by flames, smoke, harmful gases, thermal radiation, etc., produced during the fire.

(3) Common horizontal paths open to atriums, galleries, platforms, passageways, intermediate levels, etc. formed and dimensioned according to the Rule may constitute escape routes for users in adjacent rooms when the length of the escape path (measured at the centre of the escape routes, from the door of the furthest room, if the length of the dead-end corridor in the room is not exceeded to the nearest escape or exit staircase) does not exceed the maximum values permitted according to the level of fire stability of the construction, destination, fire risk and building type.

**Article 2.5.2.3.** The composition, gauges and number of escape routes, the exhaust length, the intended routes and the number of escape units (streams) provided, shall meet the requirements for the movement and escape of the users of the construction, as laid down in the Rule.

### ***2.5.3. Number of escape routes***

**Article 2.5.3.1. (1)** In constructions, with the exceptions specified in the Rule relating to this provision, at least two separate escape routes must be provided for users. The two escape routes must, with the exceptions specified in the Rule, drive in opposite directions. Fire compartments shall have at least one escape path.

(2) The provision of a single escape path for users of ordinary constructions is permitted when:

- a)** at each above-ground level of normal construction height may be up to a maximum of **10** users, regardless of the length of the escape path;
- b)** at each above-ground or underground construction level of normal height, the number of users simultaneously exceeds **10** and less than **100** users and the length of escape provided shall be within the permissible value for escape in one direction (dead-end corridor), depending on the level of fire stability, the risk of fire and operation of the building.

(3) In high, very high and crowded buildings, those with people who cannot evacuate themselves (defined according to terminology) and in other situations specified in the Rule, it is mandatory to ensure a minimum of two escape routes for users, regardless of the number of users. The provided escape routes shall also comply with the specific performance requirements for the buildings concerned.

(4) Existing buildings shall comply with their specific provisions.

### ***2.5.4. Composition and separation of functional and escape routes***

**Article 2.5.4.1. (1)** Common routes for the functional movement and escape of the construction users in the event of fire (rooms, landscapes, corridors, halls, tunnels, protected

clearance, staircases, etc.) must be safe and separated from the rest of the construction by fire resistant elements, according to the provisions of **Article 2.4.2.2.** to **Article 2.4.2.7.** for staircases, from **Article 2.4.3.1.** to **Article 2.4.3.3.** for horizontal common paths, as well as provisions on performance specific to the destination and type of buildings.

2. In production and/or storage constructions, the escape routes shall also comply with the conditions corresponding to the density of the heat load in adjacent rooms.

### **2.5.5. Doors**

**Article 2.5.5.1.** (1) Doors used on the escape routes of construction users shall be of a normal type, on hinges or pivots, or other types of doors which may be used for escape, except doors for maximum use 5 users.

(2) Manual, automatic or semi-automatic revolving doors (servo assisted) may only be used on the users' escape routes if they are equipped with the possibility of lightly folding door sheets and thereby provides the pass-through units (the clear width required to evacuate the streams) of escape resulting from the calculation. Where revolving doors do not meet these requirements, doors with ordinary opening on hinges or pivots shall be provided in their immediate vicinity to ensure the normal escape conditions.

(3) Automatic sliding doors may be used on escape routes if they meet the following conditions:

a) in the event of a defect, interruption of power supply or fire, the doors shall open automatically and remain open; the doors may be opened by pivot, folder or lateral opening (redundant sliding doors only) over the entire normal width to provide the escape pass-through units (flows) resulting from the calculation;

b) door opening shall also be ensured manually by pushing in the direction of escape outwards or by side opening with an intrinsic mechanical power device.

(4) The sliding and pivoting panels in automatic break-out sliding doors shall be located in such a way that there is no possibility of being in an intermediate position and there is no space for pivot opening. It is recommended to use cutting-pivoted doors composed of two coupled panels.

**Article 2.5.5.2.** (1) Opening of normal opening escape doors on hinges or pivots arranged on escape routes of more than 30 by users who are able to evacuate themselves must be done in the direction of their movement to the outside.

(2) By opening, escape doors shall not obstruct each other or reduce the standard width of the users' escape routes.

(3) Next to escape doors for more than 5 users able to evacuate themselves, no thresholds higher than the height of 2,5 cm shall be provided. If higher height thresholds are required, they shall be connected by slopes to the floor.

(4) Users' escape doors in large doors (hanging doors, etc.) may have thresholds of maximum height 25 cm.

(5) It is permissible to evacuate more than 5 persons through sliding doors where pedestrian doors are deployed if the following conditions are fulfilled simultaneously:

– the sliding door guidance system shall be located outside the escape space. Exception are the external doors where the guidance system is permitted to be located inside the facade;

– the opening direction of the pedestrian door shall always be towards the space where the evacuation takes place and never towards the evacuated space so as not to block when the main door slides. Exceptions are external pedestrian doors that will open in such a way that they do not lock by opening sliding doors.

– pedestrian doors shall be placed at the head opposite to the direction of closing in such a way that whatever position the sliding door can lock, the resulting gap between the wall and the sliding door shall have a width greater than or equal to the minimum required for the escape of users.

– the pedestrian door threshold shall not exceed **25 cm**.

(6) The escape of maximum **10** persons is permitted in production or storage facilities through sectional doors (sliding) where pedestrian doors are deployed. The threshold at the pedestrian door shall be maximum **25 cm**.

(7) Doors in rooms which start in common horizontal paths open to the atrium shall be formed and equipped according to the provisions of the Rule on communication between the spaces to different destinations and the escape routes through the atrium.

(8) The opening of doors at the entrance to above-ground dwelling buildings of normal heights, regardless of the number of users, may be made inwards.

(9) Installation of the joinery on escape doors, according to **SR EN 1906**, **SR EN 1125** and **SR EN 179** shall not affect the displacement through the door gap, respectively narrow the clear width required for the escape of the escape streams resulting from the calculation.

**Article 2.5.5.3. (1)** Doors for access to enclosed escape staircases, self-closing systems shall be provided **(C)**, except for access doors in accommodation apartments, and fire resistant doors shall be fitted with self-closing systems **(C)** or, where appropriate, with automatic closing in the event of fire.

(2) Access doors to/from areas provided with excess pressure, self-closing systems/devices **(C)** shall be provided

**Article 2.5.5.4. (1)** Turnstiles can be provided on the user escape routes (without projections at the floor level) that have automatic pivoting systems and provide widths corresponding to the evacuation passage units (flows), and when they do not meet these conditions, in their immediate vicinity are provided circulations (gates) or doors with regular opening on hinges or pivots, which ensure the passage of the evacuation units (flows) resulting from the calculation. The sum of the independent flows resulting from the widths of turnstiles having automatic pivot systems shall be at least equal to the sum of the required flows starting before the turnstiles.

(2) The gates in the turnstiles area can be opened manually (by joining a button placed next to them, in a glass box that can break) and automatically via the fire signalling plant in the event of fire. Doors may be opened selectively from the reception, but also centrally from the fire safety dispatcher (in the buildings where they are provided).

**Article 2.5.5.5 (1)** Doors ensuring the escape of users in the event of a fire at the level of the terrain or of a road surface not used in current functional operation, and of buildings by more than **500** level users shall be provided with automatic fire opening systems and panic bars.

(2) Doors ensuring the escape of users in the event of a fire on the ground or on a road surface, as well as doors on their escape routes in high, very high buildings and with crowded rooms, shall be provided with automatic fire opening systems and panic bars.

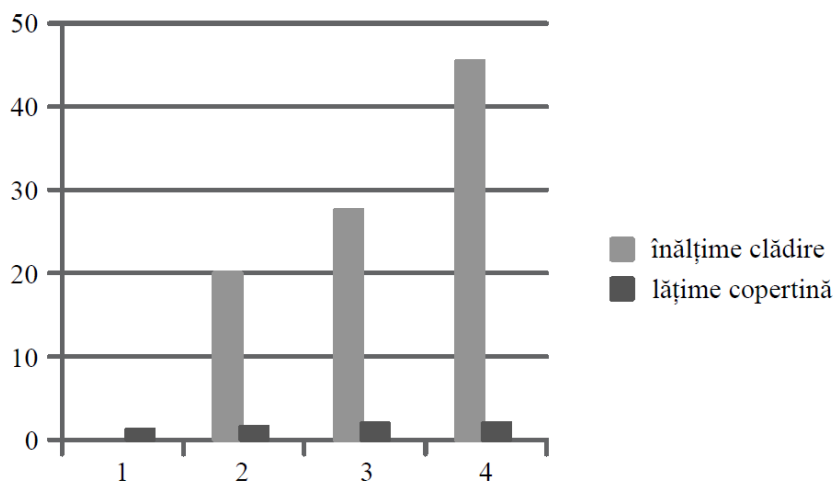
**Article 2.5.5.6.** It is recommended that in the vicinity of the access and escape door which is the last area of the escape route of persons (from a construction or fire compartment) located outside or in the immediate vicinity of the final escape door where the effects of the fire can still occur, protective covers should be provided.

(2) In all cases, the access and escape door shall be protected by a cover resistant to mechanical action from non-combustible materials, class **A1**, **A2 s1**, **d0** resistance to fire **R 15** advisable for administrative functions, culture, worship and education, and **R 30** for health functions, tourism, crowded rooms, high and very high buildings.

(3) Protecting users in the situation of internal courts with more than **3.50 m** width shall be carried out as follows:

- For buildings with heights greater than **20.00 m**, resisting covers with minimum widths of mechanical action are recommended **2.00 m** and for those with heights greater than **28.00 m**, covers which resist to mechanical action of minimum widths **3.00 m** are recommended, but at least equal to the width corresponding to the number of flows as

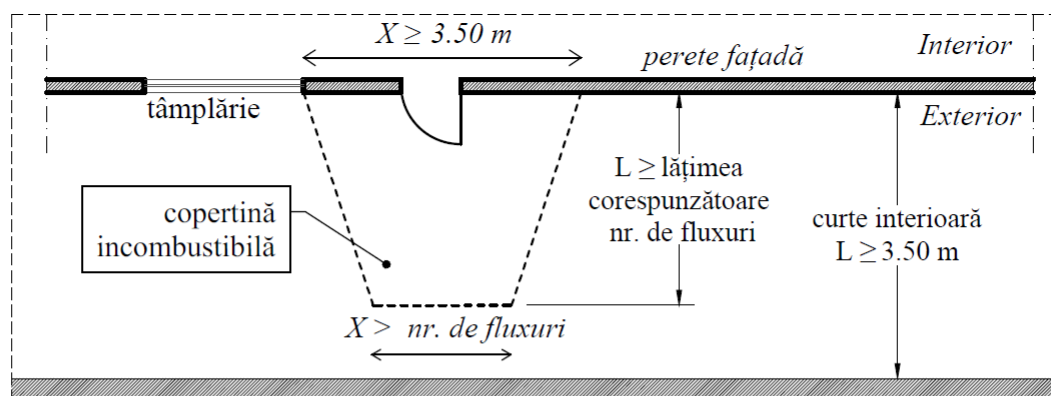
shown in Figure 55. and **Figure 57**. The height shall be measured from the terrain (adjacent road) accessible to fire service vehicles to the floor of the last useable level.



înălțime clădire	building height
lățime copertină	cover width

**Note:** the length of the cover at the large base shall be greater than or equal to **3.50 m** centred on the axis of the escape door thus protected, i.e. at the small base shall be greater than the width corresponding to the number of streams.

**Figure 55 - Building height/width of cover**



tâmplărie	joinery
copertină incombustibilă	non-combustible cover
$X > nr. de fluxuri$	$X > No of flows$
perete fațadă	façade wall
Interior	Interior
$L \geq lățimea corespunzătoare nr. de fluxuri$	$L \geq corresponding width No of flows$
Exterior	Exterior
curte interioară $L \geq 3.50m$	interior court $L \geq 3.50 m$

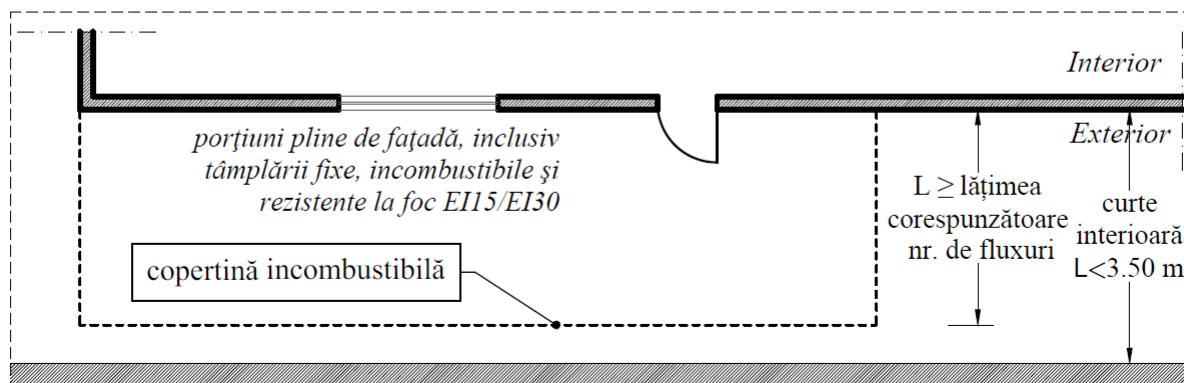
**Figure – Proximity of the access and escape door centred on the axis of the escape door<sup>56</sup> ( $X$  – cover length and  $L$  – cover width)**

- For façades whose pedestrian pavement is less than the width of the cover, the width of the pavement shall be used, in which case the length of the small base of the cover shall be equal to the length of the large base.

(4) Protecting users in the situation of internal courts narrower than **3.50 m** shall be carried out as follows: when the main or secondary access and final escape door is provided through a narrow courtyard, less than **3,5 m**, which may be affected by fire in the building under evacuation, then passive or active measures shall be ensured: full facade, non-combustible and fire-resistant

portions **EI 15** for administrative functions, culture, worship and education, respectively **EI 30** for health, tourism, crowded rooms, high and very high buildings (**Figure 57**). The minimum height for the facades treated in this way is **3.00 m** measured from the elevation of the land at which the escape takes place.

- Active measures such as automatic open sprinkler extinguishing systems may replace the protected full portions as described above if they ensure an equal operating time for the replaced element, **15 minutes** or **30 minutes**.



porțiuni pline de fațadă, inclusiv tâmplării fixe, incombustibile și rezistente la foc EI15/EI30	full facade portions, including fixed, non-combustible and fire-resistant joinery EI15/EI30
copertină incombustibilă	non-combustible cover
Interior	Interior
Exterior	Exterior
$L \geq$ lățimea corespunzătoare nr. de fluxuri	$L \geq$ corresponding width No of flows
curte interioară $L < 3.50$ m	interior court $L < 3.50$ m

**Figure 57 - Proximity of the access and escape door with a cover**

**Article 2.5.5.7** Fire resistant doors together with self-closing systems (C) shall maintain their specifications over time, based on a regular control and maintenance programme according to the supplier.

## 2.5.6. Stairways

### 2.5.6.1. General provisions

**Article 2.5.6.1.1. (1)** Stairways which ensure the escape of up to two successive above-ground levels of the construction may be opened (not enclosed in staircases), in all cases where it is permissible to provide a single escape route to users.

**(2)** Where it is mandatory to ensure a minimum of two escape routes, open stairways may only be provided if stairway enclosures, which are the second route of escape of users, are also provided.

**(3)** It is forbidden to provide one or two isolated steps on the escape routes to the doors of stairs, buffer rooms, protected clearances, tunnels, etc. or external exits or access to them. In this case, provision shall be made for a ramp complying with the standard requirements which will take over the slope.

**Article 2.5.6.1.2. (1)** Internal escape staircases for building users are recommended to be naturally illuminated and when it is not technically possible to provide artificial lighting according to the relevant technical regulations.

**(2)** Staircases that are not naturally lit and ventilated through windows with movable meshes arranged on each level through which smoke and hot gases are evacuated directly to the outside, must be provided with smoke and hot gas exhaust systems or with systems with differential pressure SPD. Staircases naturally lit and ventilated through windows with movable meshes arranged on each level shall be provided with exhaust of smoke and hot gases through movable

meshes located in the upper third of the outer walls on the last level of the staircase (and air intake according to standardised provisions) with manual operation from each level, from the main access and from the Private Fire Service room, as the case may be, and with automatic operation if the building is equipped with a fire detection, signalling and alarm system.

**Article 2.5.6.1.3. (1)** The drainage staircases shall be designed and carried out in such a way as to ensure the escape of users from the last above-ground or underground level of the building, up to the exist (at the level of the terrain or external road surfaces, or on a terrace meeting the standard conditions, from which the discharge can be continued up to the ground level). Users of enclosed escape staircases shall be able to reach, without leaving them, directly or through a hall or corridor carried out according to the provisions on performance specific to the destination and type of building, up to the level of exit.

**(2)** Exception are the stairways within accommodation apartments and interrupted stairways where escape from the point of interruption to the ground can be safely continued by terraces or other staircases or halls with direct external access. The direct connection between two interrupted internal stairways, must be achieved by means of a common stair landing.

**(3)** Where it is mandatory to ensure a minimum of two escape routes, access by users to at least two escape staircases shall be possible without passing through the shaft of either of them, and when a staircase is admitted to be open, the second staircase shall be necessarily closed.

**(4)** Halls in which escape staircases freely start, may be assimilated to staircase enclosures if they are intended for traffic or waiting only, are separated from the rest of the construction in the same way as the escape staircase and fulfil the requirements of the stairway and escape doors. Room doors adjacent to the hall shall be fitted with self-closing devices **(C)**.

**Article 2.5.6.1.4. (1)** Exit from the escape staircase at the level of the terrain or external road surfaces, it is compulsory to ensure:

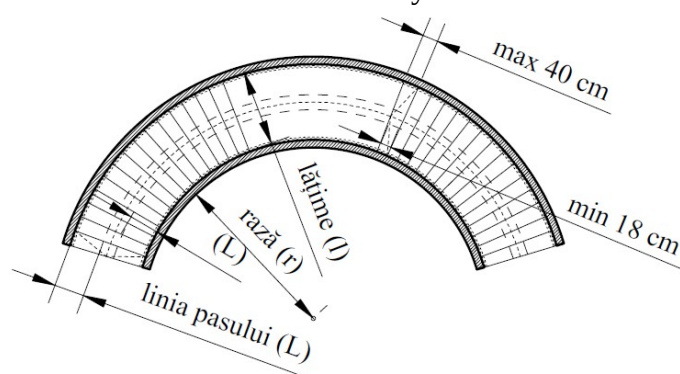
- a)** directly to the outside;
- b)** through a hall or entrance hall with a standardized escape length for each building type and/or function and protected according to standardized conditions, provided that the ratio between its width and length does not exceed 1/2;
- c)** through a corridor with a normal escape length in one direction (dead-end corridor) for each building type and/or operation and protected under standardised conditions, provided that it is the only escape path from the staircase until the direct exit to the outside;
- d)** protected clearance (corridor, escape tunnel) of maximum length **200 m**, over pressurised and made up of elements having fire resistances corresponding to the heat load density (**q**) in adjacent rooms and/or made up according to the minimum requirements to be met by walls and corridor separation floors in buildings, but not less than **EI/REI 120** for walls and standardised **REI** for floors according to the level of fire stability (but minimum) **REI 60** for floors). When elements with fire resistances are found in the specific uses detailed in the Rule, the composition of the protected release shall meet the most stringent performance conditions laid down in the Rule for those functions. Operating and escape gaps in clearance bulkheads shall be protected by fire resistant and smoke tight doors of minimum **EI<sub>2</sub> 90-C5S<sub>200</sub>** towards rooms with heat load density (**q**) greater than **840 MJ/m<sup>2</sup>**, with fire resistant and smoke tight doors as a minimum **EI<sub>2</sub> 60-C5S<sub>200</sub>** towards rooms with heat load density (**q**) greater than **420 MJ/m<sup>2</sup>** and with fire resistant and smoke tight doors **EI<sub>2</sub>30-C5S<sub>a</sub>** towards rooms with density of heat load (**q**) less than **420 MJ/m<sup>2</sup>**. When functional and escape separation elements are found in the specific destinations detailed in the Rule, the most stringent standard protection measures are ensured.

**(2)** Where a minimum of two escape routes for construction users are mandatory, separate exits shall be provided to the outside.

**Article 2.5.6.1.5. (1)** The inclination of the ramps of the escape staircases, the surface and the shape of the steps and floors must allow users to circulate easily and safely, according to the provisions of the applicable technical regulations.

**(2)** Spiral staircases are considered as escape routes only for a single user escape (flow) unit, when they meet the composition and dimensioning conditions laid down in the Rule and technical regulations specific to the stairways.

**(3)** Curved (helical) staircases are considered as escape routes for users only in parts of ramps where the minimum width of the step is **18 cm** and the maximum width is **40 cm** for one or more user pass-through (flow) units (Figure 58), when they meet the composition and dimensioning conditions laid down in the stair-specific technical regulations (step line, etc.) and the internal radius of curvature is at least twice the width of the stairway.



max 40 cm	max 40 cm
min 18 cm	min. 18 cm
lățime (l)	width (l)
rază (r)	radius (r)
linia pasului (L)	step line (L)

**Figure 58 – Curved ramp (helical) staircases which are considered as escape routes for several pass-through units (flows)**

**(4)** Staircases with swinging steps may be considered as escape routes only for a user's escape (flow) unit, if they meet the composition conditions laid down in the Rule and dimensioning laid down in the technical regulations specific to the staircases.

**Article 2.5.6.1.6. (1)** Escape staircases of constructions may be replaced by inclined escape planes if they comply with the provisions of the Rule and technical regulations relating to staircases (arrangement, closure, fire resistance, dimensioning, etc.).

**(2)** Inclined escape planes may have slopes not exceeding **10 %** when inside the construction and not exceeding **8 %** when outside of it, being provided with a layer of rough wear to prevent users from sliding. In buildings where children of pre-school and persons with disabilities are present, the provisions of the specific rules shall be complied with.

**Article 2.5.6.1.7. (1)** Open inclined rolling plans may be provided for in construction, provided that fixed user escape staircases are also provided, formed and carried out according to the provisions of the Rule.

**(2)** Open inclined rolling plans used in construction shall:

**a)** ensure that the slight spread of smoke and fire from one level to another of the construction is prevented by placing continuous fire resistant screens on the contour of the floor as a minimum; **DH 60** for the level of **I** and **II** of fire stability and minimum **DH 30** for other levels of fire stability, with a minimum height **50 cm** (below the floor) and with sprinklers, over the entire length of the screens, with the installation's normal operating time of minimum **60** minutes;

**b)** be executed from materials **A1** or **A2 - s1,d0** except handrails and drive wheels



c) in conditions under which they cannot be executed in accordance with point (b) and be provided with systems, local, automatic spray fire-extinguishing machines according to the profile regulation;

d) be powered by elective power from two independent sources, one basic and a back-up source;

e) the nearest user escape path is indicated at each level of construction;

(3) Open inclined rolling plans, which meet the conditions referred to in **paragraph 2**, a single escape passing (flow) unit shall be deemed to provide, regardless of their width and number.

**Article 2.5.6.1.8. (1)** In double-deck structures, the lifting of fire intervention hoses to the place where they are to be used may be carried out by direct outward windows of staircases, unless protruding covers or constructional features preventing hoses from being raised are provided below these windows.

(2) Where staircases do not have direct outward windows or windows provided are not accessible in case of fire-extinguishing intervention, or are provided with covers/other building elements which impede access by the intervention team, gaps shall be provided in staircases between stairway ramps of at least **20** cm, situated on the same vertical or in staircases, shall be provided with dry columns intended for the supply of water in the event of fire.

(3) Dry columns intended for the supply of water in the event of fire shall be carried out according to the provisions of the applicable technical regulations.

### **2.5.6.2. Closed interior staircases**

**Article 2.5.6.2.1.** The separation walls from the rest of the building of the user escape staircases shall meet the minimum conditions for reaction to fire and fire resistance laid down in the Rule. In high, very high buildings or with crowded rooms, their specific conditions will also be respected. Escape stairway partitions from rooms of fire risk and/or volumetric explosion shall also meet the conditions specific to those risks.

**Article 2.5.6.2.2. (1)** In the interior walls of closed staircases used for evacuation, only functional gaps for circulation and access/evacuation from the construction levels can be practiced. In staircases, covers or doors for inspection of installations are not allowed, with the exception of residential buildings with a normal rise, when there are no common horizontal circulations (hallways and/or corridors), independent of the stairwell. Access from enclosed staircases to waste or other material collector tubes is mandatory by means of a protected buffer room according to **Article 2.4.15.2**.

(2) For civil constructions of ordinary heights, gaps for indirect natural lighting may be provided in the internal walls of enclosed staircases, gaps protected by fixed fire resistant elements as a minimum **EW 30** and only arranged to rooms with density of heat load (**q**), under **105 MJ/m<sup>2</sup>**. In buildings with fire stability level I, the gaps for indirect natural lighting from corridors to stairwells must be protected with fixed fire-resistant elements at least EW 60, buildings with fire stability level II must be protected with fixed fire-resistant elements at least EW 45, and in buildings with fire stability levels III and IV, with fixed elements resistant to fire at least EW 30. Gaps for indirect natural lighting from rooms with heat load density (**q**) less than **420MJ/m<sup>2</sup>** (except corridors) to stairwells must be protected with fire-resistant fixed elements of at least the same performance (**EI** instead of **EW**).

(3) In production and storage buildings with the level of fire stability **I**, gaps for indirect natural lighting from corridors/halls to staircases shall be protected with minimum fire resistant fixed elements **EW 60**, in buildings with fire stability **II** shall be protected with minimum fire resistant fixed elements **EW 45**, and building with fire stability levels **III** and **IV** with minimum fire resistant fixed elements **EW 30**. In production and storage buildings with the level of fire stability **I**, natural indirect illumination gaps from thermal load density rooms (**q**), less than **420 MJ/m<sup>2</sup>** with the exception of corridors/halls to staircases shall be protected with minimum fire resistant fixed

elements **EI 60**, in buildings with fire stability **II** shall be protected with minimum fire resistant fixed elements **EI 45**, and building with fire stability levels **III** and **IV** with minimum fire resistant fixed elements **EI 30**.

(4) In user enclosed staircases, the location (free or closed), only of passenger lifts is permitted.

**Article 2.5.6.2.3. (1)** The ramps of enclosed escape staircases of overground levels shall be separated from underground ramps.

(2) Underground ramps of enclosed interior staircases placed in the continuation of above-ground ramps shall be separated from ramps corresponding to above ground levels by minimum fire-resistant walls **EI/REI 120** and fire resistant floors **REI 60**. Functional communication between the ramps of the underground staircases and the ramps of the above-ground stairs of the building is permitted only through a fire-resistant and smoke-tight door **EI<sub>2</sub> 90-C5S<sub>200</sub>** arranged at the elevation of the ground floor or intermediate layer between the ground floor and ground floor, with opening in the direction of escape.

(3) Exception make the ramps of enclosed escape staircases of freely continued overhead levels in the basement of buildings, when providing access to rooms and spaces with the same functions, or the activities in the subsoil are functionally linked to those above ground. Basement rooms or spaces where above-ground ramps freely continue, shall be separated from other destinations by minimum fire resistant bulkheads **EI/REI 180** and communication voids shall be protected with fire resistant and smoke tight doors **EI<sub>2</sub> 90-C5S<sub>200</sub>**.

(4) When there is no communication between underground and above-ground ramps, the exist in the ground floor hall of the underground ramp shall be protected with a fire-resistant and smoke tight door **EI<sub>2</sub> 60-C5S<sub>200</sub>**.

**Article 2.5.6.2.4.** In the escape staircases, it is not allowed to provide or set up work spaces, storage spaces or for other purposes, as well as the installation of natural gas pipes for technological uses, pipes for combustible liquids or waste collection tubes or other materials.

**Article 2.5.6.2.5.** The hall, vestibule or corridor in which escape staircases freely start may be assimilated to staircases enclosures if they are intended for traffic or waiting only. They shall be separated from the rest of the building by fire resistant walls and floors according to the regulatory provisions for staircases enclosures. Doors in adjacent rooms shall have fire performance at least equal to that of doors associated with staircases enclosures. The hallways can communicate freely with supervised dressing rooms, reception rooms for the public and necessary functional areas (trade, food, meetings, etc.).

**Article 2.5.6.2.6.** Educational constructions shall have escape staircases enclosed in staircase houses, regardless of the number of construction levels (overground or underground).

### **2.5.6.3. Open interior staircases**

**Article 2.5.6.3.1. (1)** Monumental building staircases may be opened (not enclosed in staircases), provided that enclosed stairways are also provided to ensure the escape of users.

(2) Open stairways located in the atrium volume with a height not exceeding four levels of construction constitute a route of escape to users in the event of fire for an escape (flow) unit, even if the width of ramps provides several crossing units (flows) and regardless of the number of open stairways.

(3) Open internal staircases are made of materials of the reaction to fire class **A1** or **A2-s1d0**. As an exception, open internal staircases of individual dwellings ensuring the escape of the users of the floor or hinges, as well as stairways inside duplex or triplex apartments (regardless of the type of housing building), may be made of materials of the reaction to fire class **C** or **D**.

**Article 2.5.6.3.2.** In cases where open internal escape staircases are permitted, they may be ensured that users leave the outside through the spaces in which they are arranged.

**Article 2.5.6.3.3. (1)** Open escalators may be provided for in constructions, provided that fixed escape staircases for users are also provided and constructed according to the provisions of the Rule.

**(2)** Open escalators used in construction shall:

**a)** ensure that the slight spread of smoke and fire from one level to another of the construction is prevented by placing continuous fire resistant screens on the contour of the floor as a minimum; **DH 60** for the level of **I** and **II** of fire stability and minimum **DH 30** for other levels of fire stability, with a minimum height **50 cm** (below the floor) and with sprinklers, over the entire length of the screens, with the installation's normal operating time of minimum **60** minutes;

**b)** be automatically and manually switched off from each level by easily accessible control;

**c)** indicate the closest route of escape of users at each level of construction;

**d)** ensure the width of the steps of a minimum **25 cm**.

**(3)** Open escalators, fulfilling the conditions referred to in **paragraph 2**, a single exhaust passage (flow) unit shall be deemed to provide, regardless of the width of their ramp and regardless of their number.

**Article 2.5.6.3.4. (1)** Regardless of their number, open internal stairways, including monumental stairways, shall be considered to be all together a single escape path, a second escape path being through a closed staircase, or an external escape staircase.

**(2)** To prevent light spread of smoke and fire from one construction level to another, open internal slides shall be prevented on the contour of the floor with continuous fire resistant screens. **DH 60** for the level of **I** and **II** of fire stability and minimum **DH 30** for other levels of fire stability, with a minimum height **50 cm** (below the floor) and sprinklers, over the entire length of the screens, with the installation's normal operating time of minimum **60** minutes, provided that the building is equipped with this type of extinguishing installation.

**(3)** Open internal staircases shall indicate the nearest user escape path at each level of construction;

**(4)** Open internal stairs, including monumental stairways, serve to evacuate up to two successive above-ground levels above the level by which the escape takes place outside the building.

#### **2.5.6.4. Open external staircases**

**Article 2.5.6.4.1. (1)** Open external staircases may replace or be a continuation of the required internal escape staircases if they are made of materials the reaction to fire class **A1** or **A2-s1, d0** minimum fire resistant **R 15 (R 30)** in high and/or very high buildings, and **R60** in high elevated buildings  $\geq 125$  m) comply with the provisions relating to the size of the escape staircases and are protected from the smoke and thermal radiation of fires in construction and surroundings.

**(2)** Open external escape staircases may be located at a minimum **3 m** no more than three sides may be allotted to gaps or display lights of the walls of the building.

**(3)** Open external escape staircases must be so located or protected that the circulation of users cannot be blocked due to damage to pipes through which steam, combustible liquids or gases, acids or toxic substances, etc. are conveyed less than **3 m** the staircase gauge.

**(4)** For buildings above **28 m** open external staircases shall be provided with open permeable protection (grill, netting, blades or similar), continuous, throughout the free height of the staircase.

**(5)** The protection of external escape staircases in the event of fire is considered satisfactory by placing them next to parts full of minimum fire-resistant walls **EW 15** when outdoor escape

staircases are more than **1 m** of the external parts of the construction (but less than **3 m** in relation to them), minimum **EI 15** when outdoor escape staircases are less than **1 m** of the external parts of the construction exceeding by at least **3 m** staircase gauge, or by shielding the open external staircase with minimum fire resistant elements **EW15/EI15** (in line with the previous specification) of the voids in the building walls and ducts referred to in **paragraph 3**. For high and/or very high fire buildings/compartments the shielding of the open exterior staircase shall be carried out with minimum fire resistant elements **EW30/EI30** (in line with the previous specification) and for those very high in height  $\geq 125$  m the external open staircase is shielded with minimum fire resistant elements **EW60/EI60** (in line with the previous specification).

**(6)** Gaps of access to open external escape stairways shall be protected by fire resistant and smoke tight doors **EI<sub>2</sub>15-C5S<sub>a</sub>** minimum (**EI<sub>2</sub>30-C5S<sub>a</sub>** high and/or very high and minimum **EI<sub>2</sub>60-C5S<sub>a</sub>** in high elevated buildings  $\geq 125$  m, excluding doors at the last level of the building.

**Article 2.5.6.4.2.** Over-ground double-deck constructions of kindergartens shall be provided with an external exhaust staircase sized according to the number of users and the type of users, regardless of the number of internal stairs envisaged.

### **2.5.7. Trafficable terraces, curves, logs and internal courts**

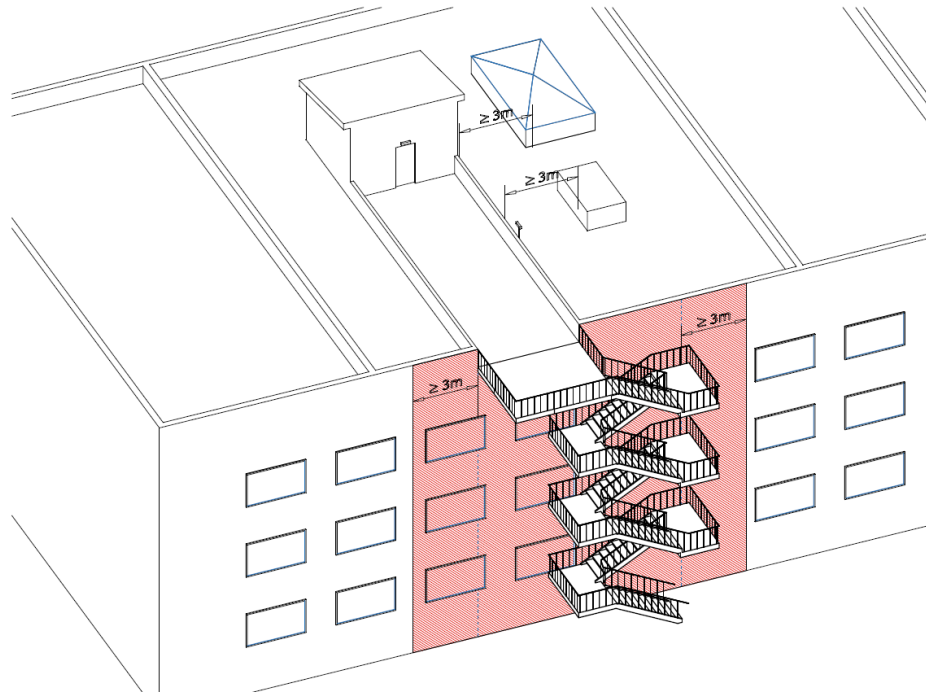
**Article 2.5.7.1. (1)** Trafficable terraces, curves and loggia of constructions constituting escape routes for users in the event of fire shall ensure the passage width resulting from the calculation, shall be fire resistant as a minimum. **REI 60** and protected against traffic lock-in by falling on elements of the building.

**(2)** Terraces with a width of less than **6 m** curves and statuses intended for the escape of users must be protected against the effects of fires at the lower levels of construction or in the vicinity, with bulwarks full of at least **1.20 m** height, minimum fire resistant **EI/REI 30**.

**(3)** May also be used for the escape of users and parts of non-circular terraces meeting the conditions referred to in **paragraph 1** and **paragraph 2** and have ensured measures to mark, organise and protect established routes for evacuation.

**(4)** The circulation of users cannot be blocked as a result of damage to pipes through which steam, combustible liquids or gases, acids or toxic substances, etc. are conveyed less than **3 m** the staircase gauge.

**(5)** It is considered satisfactory to protect the paths provided for the escape of users by placing them in front of parts full of minimum fire-resistant walls. **EW 15** exceeding by at least **3 m** traffic gauge or by shielding with minimum fire resistant elements **EI 15/EW 15** with respect to the gaps in the walls of the construction and the ducts referred to in **par. (4)**. (*according to Figure 59*).



**Figure 59 - Protection of paths intended for the escape of users from the terrace**

**Article 2.5.7.2.** Internal courts and gaps between constructions may be taken into account for the escape of users in the event of fire, if they are of sufficient width to pass the number of escape units (flows) resulting from the calculation, but not less than **3 m** width.

### **2.5.8. Sizing of escape routes**

**Article 2.5.8.1.** Calculation of the escape routes (for more than 5 persons) consists of determining the required gauges and respecting the normal length of routes so as to ensure rapid escape from the construction over the normal distance.

**Article 2.5.8.2. (1)** The escape of building users shall be deemed to take place in an orderly manner in exhaust flow (s) units travelling on the roads and evacuations to the outside.

**(2)** The determination of the exhaust flow (s) shall be done by calculation.

**Article 2.5.8.3.** The number of flows to be ensured for the escape of persons and the gauges required to pass the exhaust streams shall be calculated according to the provisions of the standard.

**Article 2.5.8.4. (1)** When determining the number of drainage units (streams) to be ensured for the escape of building users on stairways, the following shall be taken into account:

a) the width of exhaust stairway ramps is determined by the level of construction from which the highest number of escape pass-through units (flows) originates, except in cases where users at different levels can simultaneously observe the fire (intermediate levels, open galleries, atriums and gaps in the floor) and move simultaneously to stairways, in which case the width of the ramps shall be determined by the number of flows from the most congested level, to which shall be added for each of the other levels discharged by the staircase, the width required for the discharge of **25 %** from the users at that level;

**b)** if above the level determining the width of the ramps of the staircase are construction levels with a smaller number of users (attic, retracted level, etc.), the associated scale portion may be smaller in width, dimensioning as appropriate to **point (a)**;

**c)** each floor of the escape staircases shall be at least wide with the widest ramp it intersects;

d) in branched ramp staircases, the width shall be determined for the main ramp and the width of each branched ramp shall be at least **60 %** the width of the main ramp and the width of the floor of branched ramps shall be at least the width of the widest branched ramp; each floor of the escape staircases shall have a width equal to the widest ramp it intersects.

(2) Where atriums as well as floor voids are located in buildings with automatic sprinkler installations, the width of the ramps of the escape staircases shall be determined by the level of construction from which the highest number of escape pass-through units (flows) originates.

**Article 2.5.8.5.** Where the inner escape routes of users of the above-ground and underground levels of the construction have provided the outdoor exit through the same space (hall, vestibule, corridor, etc.), the width of the outdoor escape doors shall be such that the total number of users determined by the sum of:

- a) number of users coming through internal stairways at the busiest level of construction, determined correspondingly **Article 2.5.8.4**;
- b) **60 %** the number of users at the level at which the outdoor escape of the construction is ensured;
- c) **60 %** the number of users coming through internal staircases at levels below/above the outdoor escape.

### 2.5.9. Number of users

**Article 2.5.9.1.** The determination of the number of users for whom the conditions for escape in the event of fire in rooms, construction levels and in the building/fire compartment are ensured shall take into account the occupancy and the maximum simultaneous capacity of users, taken into account according to the destination. The maximum simultaneous user capabilities shall be specified in the technical design documentation as well as in the fire safety documentation (escape of users and response to fire).

**Article 2.5.9.2 1.** The maximum number of persons in buildings at the same time shall be determined for each destination as follows:

**Table 23: Minimum number of persons in residential buildings at the same time**

Reference No	Destination/operation	Observation	Type of audience	Useful area (m <sup>2</sup> )/persons.	Destination/function of the area considered in the calculation	Increment [%]	Staff to whom increment is granted
1	Dwellings (individual and shared)	-	-	20	Dwelling/Utility dwelling	-	-
2	Rooms with various functions/destinations	According to the classification 'rooms specific to several functions/destinations of civil buildings' or assimilation to existing ones.					

**Table 24: Minimum number of persons simultaneously in administrative buildings – central or local governments, financial-banking, trade unions, parties, offices**

Reference No	Destination/operation	Observation	Type of audience	Useful area (m <sup>2</sup> )/pers.	Destination/function of the area considered in the calculation	Increment [%]	Staff to whom increment is granted
1	Administrative offices	-	No public	5.00	Office – plan closed or less than 60 m <sup>2</sup>	-	-
				7.00	Office – plan open or over 60 m <sup>2</sup>		
			Low public presence, established by the project	5.00	Office – plan closed or less than 60 m <sup>2</sup>	From 5 to 20	Public or visitors/foreign persons
				7.00	Office – Office open space or more than 60 m <sup>2</sup>		
			Highly influential by the public, established by the project	5.00	Office – plan closed or less than 60 m <sup>2</sup>	From 20 to 75	Public or visitors/foreign persons
				7.00	Office – plan open or over 60 m <sup>2</sup>		
2	Rooms with various functions/destinations	According to the classification “rooms specific to several functions/destinations of civilian buildings”, destinations/functions in the different buildings or assimilation to existing ones.					

**Note:**

The number of persons can also be determined by the proposed furnishing, but the values in the table are minimal and mandatory.

**Table 25: Minimum number of people at the same time in retail buildings – shops, shopping centres and complexes, shopping galleries, hypermarkets or supermarkets with an area of up to 1 500 m<sup>2</sup>**

Reference No	Destination/operation	Reference level	Useful area (m <sup>2</sup> )/pers.	Destination/function of the area considered in the calculation	Increment [%]	Staff to whom increment is granted	
1	Shops with the smaller area of 500 m <sup>2</sup>	Ground floor	4.00	Buyer accessible areas – consider 2/3 in the area accessible to the public (sale and circulation)	10	Sales staff and supermarkets.	
		Basements 1 and 2 and floors 1 and 2 (compared to the baseline)	5.00		10		
		Other levels of construction	5.00		10		
2	Retail stores, centres and complexes, shopping galleries, hypermarkets or supermarkets with a larger or equal area to 500 m <sup>2</sup> , and maximum 1 500 m <sup>2</sup>	At any level of construction	5.00	Buyer accessible areas – consider 2/3 in the area accessible to the public (sale and circulation)	10	Sales staff and supermarkets.	
3	Rooms with various	According to the classification “rooms specific to several					

Reference No	Destination/operation	Reference level	Useful area (m <sup>2</sup> )/pers.	Destination/function of the area considered in the calculation	Increment [%]	Staff to whom increment is granted
	functions/destinations	functions/destinations of civilian buildings”, destinations/functions in the different buildings or assimilation to existing ones.				

**Table 26: Minimum number of persons simultaneously in commercial buildings – Shops, shopping centres and complexes, shopping galleries, hypermarkets or supermarkets with a deployed area equal to or greater than 1 500 m<sup>2</sup>**

Reference No	Destination/operation	Reference level	Useful area (m <sup>2</sup> )/pers.	Destination/function of the area considered in the calculation	Increment [%]	Staff to whom increment is granted
1	Shops, shopping centres and complexes, shopping galleries, hypermarkets, supermarkets and malls	In any construction level	5.00	Buyer accessible areas – consider 2/3 in the area accessible to the public (sale and circulation)	10	Sales staff and supermarkets
2	Cash & Carry		10.00		10	
3	DIY (do-it-yourself)		12.00		10	
4	Specialised shop (furniture, household appliances, etc.)		8.00		10	

**Note:**

Alternative to those stipulated in heading No 1 2 or 3 for shops, shopping centres and complexes, shopping galleries, hypermarkets, supermarkets and malls, Cash & Carry or DIY (do-it-yourself), the area to which a person is responsible can be considered to be: 4 m<sup>2</sup> in the area accessible to buyers.

**Table 27: Minimum number of persons simultaneously in commercial buildings – catering**

Reference No	Destination/operation	Reference level	Useful area (m <sup>2</sup> )/pers.	Destination/function of the area considered in the calculation	Increment [%]	Staff for who the increment is granted
1	Club and similar to the same function	In any construction level	0.50	Areas accessible to the public – consider the total useful area accessible to the public (sale and circulation).	10	Service staff.
2	Bar, pub, beverage, confectionery, buffet, pastry, broom, pub, cafeteria, café, bar, bistro, snack, etc.		4.50		10	
3	Dance discotheque/ring, cabaret, American bar, etc.		0.50/ 0.75		10	
4	Restaurant, canteen-restaurant, fast food, restaurant – self-service, dining room, event room, canteen, etc.		4.50		10	

**Note:**



The number of persons can also be determined by the proposed furnishing, but the values in the table are minimal and mandatory.

**Table 28: Minimum number of persons simultaneously in commercial buildings – other premises for commerce**

Reference No	Destination/operation	Reference level	Useful area (m <sup>2</sup> )/pers.	Destination/function of the area considered in the calculation	Increment [%]	Staff for whom the increment is granted
1	Markets/bazaars	In any level of construction	5.00	Areas accessible to the public – consider the total useful area accessible to the public (sale and circulation).	20	Service/sales/supermarket staff.
2	Betting office		5.00		10	
3	Showroom		7.00		10	
4	Ice rink		4.00 - 5.00		10	
5	Games rooms/ casino		4.00 - 5.00		10	
6	Billiard room/snooker		10.00		10	
7	Bingo room		4.00		10	
8	Bowling room		10.00		10	
9	Power room with apparatus		8.00		10	
10	Bookshops with shelves on walls		5.00		10	
11	Bookshop with shelves on walls and seating positions fixed by reading		5.00		10	
12	Bookshop with shelves on walls and seating positions not fixed by reading		5.00		10	
13	Supply of public services (barbers' lounges, hairdressers, manicure, etc.)		5.00		10	
14	Car Service		15.00		20	
15	Fitness room, aerobic without apparatus, etc.		5.00		10	
16	Sports and leisure facilities (swimming pools, spa areas)		5.00		10	

**Table 29: Minimum number of persons in buildings for health at the same time**

Reference No	Destination/operation	Remarks	Reference level	Useful area (m <sup>2</sup> )/pers.	Destination/function of the area considered in the calculation	Increment [%]	Staff for whom the increment is granted
1	Parking areas – salons/sections Adults	The number of persons at the same time may be specified according to the number of beds plus staff allowance.	In any level of construction	According to remarks	Sick chambers	100	Medical staff, patients waiting for distribution/treatment, visitors, etc.
2	Parking areas – children's lounges/sections			According to remarks			
3	Portions of outpatient			Adults/			

Reference No	Destination/operation	Remarks	Reference level	Useful area (m <sup>2</sup> )/pers.	Destination/function of the area considered in the calculation	Increment [%]	Staff for whom the increment is granted
	treatments and consultations in hospitals, maternal patients, polyclinics, dispensaries, etc.	children		8.00	cabinets		
4	Waiting portions in hospitals, maternity, polyclinics, dispensation, etc.	Adults/children		6.00	Waiting areas	100	
5	children's homes, old people's homes, sanatoria	The number of persons at the same time may be specified according to the number of beds plus staff allowance.		According to remarks	Housing rooms	50	
6	crèches	<b>According to the specific regulation NP 022</b>					
7	Rooms with various functions/destinations	According to the classification "rooms specific to several functions/destinations of civilian buildings", destinations/functions in the different buildings or assimilation to existing ones.					

**Table 30: Minimum number of persons simultaneously in buildings for culture**

Reference No	Destination/operation	Remarks	Reference level	Useful area (m <sup>2</sup> )/pers.	Destination/function of the area considered in the calculation	Increment [%]	Staff for whom the increment is granted
1	Temporary exhibitions operating in permanent premises		In any construction level	4.50	Areas accessible to the public	10	Exhibits and maintenance personnel
2	Exhibitions of a permanent nature			4.50	Areas accessible to the public	10	
3	Exhibition rooms			4.50		5	
4	Museums			5.00		5	
5	Art galleries			5.00		5	
6	Reading rooms in libraries with shelves on walls	In seating areas, the number of persons at the same time		3.00	Reading rooms	5	Service, maintenance staff, etc.
7	Reading rooms in segregated libraries			3.00		5	

Reference No	Destination/operation	Remarks	Reference level	Useful area (m <sup>2</sup> )/pers.	Destination/function of the area considered in the calculation	Increment [%]	Staff for who the increment is granted
8	Culture rooms	may be specified according to the number of seating positions (according to the corresponding area of each site determined by the project) plus the staff increment.		1.00 (or according to the remark)	Rooms for shows, gatherings, etc.	10	
9	Cultural centres and complexes					10	
10	Theatres					10	
11	Cinema, opera, operetta, etc.					10	
12	Multi-purpose rooms					10	
13	Rooms with various functions/destinations	According to the classification "rooms specific to several functions/destinations of civilian buildings", destinations/functions in the different buildings or assimilation to existing ones.					

**Note:**

The number of persons can also be determined by the proposed furnishing, but the values in the table are minimal and mandatory.

**Table 31: Minimum number of persons simultaneously in educational buildings**

Reference No	Destination/operation	Remarks	Reference level	Useful area (m <sup>2</sup> )/pers.	Destination/function of the area considered in the calculation	Increment [%]	Staff for who the increment is granted		
1	Class room	The number of persons at the same time may also be indicated according to the number of seating positions plus staff increments.	At any level of construction	2.50 (or according to remarks)		3			
2	Laboratory/workshop			3.50 (or according to remarks)					
3	Multimedia room, representations, theatre club			4.00 (or according to remarks)					
4	Library			2.50 (or according to remarks)					
5	Pupil diet			2.00 (or according to remarks)			5		
6	Administrative			2.00 (or according to remarks)				-	-
7	Medical			8.00 (or				100	

Reference No	Destination/operation	Remarks	Reference level	Useful area (m <sup>2</sup> )/pers.	Destination/function of the area considered in the calculation	Increment [%]	Staff for who the increment is granted
				according to remarks)			
8	Sports halls			8.00	Education rooms	10	Teacher
9	Changing rooms			2.00 (or according to remarks)		-	
10	Rooms with various functions/destinations	According to the classification “rooms specific to several functions/destinations of civilian buildings”, destinations/functions in the different buildings or assimilation to existing ones.					

**Note:**

Only the area outside the game area shall be taken into account for sports rooms provided with graduations. The number of persons determined according to the table shall be cumulated with the number of toys and arbitrators according to the sport practised.

The number of persons can also be determined by the proposed furnishing, but the values in the table are minimal and mandatory.

**Table 32: Minimum number of persons simultaneously in buildings for tourism**

Reference No	Destination/operation	Remarks	Reference level	Useful area (m <sup>2</sup> )/pers.	Destination/function of the area considered in the calculation	Increment [%]	Staff for who the increment is granted
1	Hotels, hostels, motels, villas, bungalows, alpine lodge, boarding houses, etc.	The number of persons at the same time may be specified according to the number of accommodation places plus staff allowance.	In any construction level	8.00-15.00 or according to remarks	Accommodation rooms, bedrooms, bunks, etc.	15	Service, administrative staff, visitors, etc.
2	rooms with various functions/destinations	According to the classification “rooms specific to several functions/destinations of civilian buildings”, destinations/functions in the different buildings or assimilation to existing ones.					

**Table 33: Minimum number of persons at the same time in worship buildings**

Reference No	Destination/operation	Remarks	Reference level	Useful area (m <sup>2</sup> )/pers.	Destination/function of the area considered in the calculation	Increment [%]	Staff to whom increment is granted
1	Cathedrals, churches, places of worship,	The number of persons at the same time may be	In any constructi	according to	Places of worship	5	Service staff

Reference No	Destination/operation	Remarks	Reference level	Useful area (m <sup>2</sup> )/pers.	Destination/function of the area considered in the calculation	Increment [%]	Staff to whom increment is granted
	synagogue, temple, prayer houses, etc.), church ensembles	specified according to the number of places of work.	on level	remarks (but not less than 2)	accessible to the public.		
2	Rooms with various functions/destinations	According to the classification "rooms specific to several functions/destinations of civilian buildings", destinations/functions in the different buildings or assimilation to existing ones.					

**Table 34: Minimum number of persons simultaneously in sports buildings**

Reference No	Destination/operation	Remarks	Reference level	Useful area (m <sup>2</sup> )/pers.	Destination/function of the area considered in the calculation	Increment [%]	Staff to whom increment is granted
1	Buildings with galleries	The number of persons at the same time may also be indicated according to the number of seating positions plus staff increments.	In any construction level	(according to remarks)	Sports halls	5	Service/security/sales/supermarket staff.
2	Rooms with various functions/destinations	According to the classification "rooms specific to several functions/destinations of civilian buildings", destinations/functions in the different buildings or assimilation to existing ones.					

Notes:

For gyms, the surface outside the game area shall be taken into account. The number of persons determined according to the table shall be cumulated with the number of toys and arbitrators according to the sport practised.

The number of persons can also be determined by the proposed furnishing, but the values in the table are minimal and mandatory.

**Table 35: Minimum number of persons from ordinary, mountainous or Danube Delta civil structures simultaneously located in isolation**

Reference No	Destination/operation	Remarks	Reference level	Area (m <sup>2</sup> )/pers.	Destination/function of the area considered in the calculation	Increment [%]	Staff to whom increment is granted
1	Alpine lodges, refuges, hotels, motels, guesthouses, health resorts,	The number of persons at the same time may be specified according to the	In any construction level	According to remarks	Areas accessible to the public	According to classification	According to the classification

Reference No	Destination/operation	Remarks	Reference level	Area (m <sup>2</sup> )/pers.	Destination/function of the area considered in the calculation	Increment [%]	Staff to whom increment is granted
	etc.	number of accommodation places plus staff allowance.				on	
2	Rooms with various functions/destinations	According to the classification in areas of commerce, administration, art/culture, health, education, tourism, sport etc. According to the classification of 'rooms specific to several functions/uses of civil buildings', destinations/functions in the various buildings or assimilation to existing ones.					

**Table 36: Minimum number of persons in car parks at the same time**

Reference No	Destination/operation	Remarks	Reference level	Area (m <sup>2</sup> )/pers.	Destination/function of the area considered in the calculation	Increment [%]	Staff to whom increment is granted
1	Above-ground car parks	According to specialist regulations (15 % of the number of cars covered by the project and 2 persons in each car).			Parking	-	Security/surveillance staff.
2	Underground car parks						
3	Rooms with various functions/destinations	According to the classification "rooms specific to several functions/destinations of civilian buildings", destinations/functions in the different buildings or assimilation to existing ones.					

**Table 37: Minimum number of construction and outdoor civilian amenities at the same time**

Reference No	Destination/operation	Remarks	Reference level	Useful area (m <sup>2</sup> )/pers.	Destination/function of the area considered in the calculation	Increment [%]	Staff to whom increment is granted
1	Stadiums, sports arenas	The number of persons at the same time may also be indicated according to the number of seating positions plus staff increments.	In any level of construction	0.60 or according to remarks	Sports constructions	5	Service/security/sales/supermarket staff.
2	Facilities not covered with floors for outdoor performances	The number of persons at the same time may also be indicated according to the number of		according to remarks		10	

Reference No	Destination/operation	Remarks	Reference level	Useful area (m <sup>2</sup> )/pers.	Destination /function of the area considered in the calculation	Increment [%]	Staff to whom increment is granted
		seating positions plus staff increments.		rks			
3	Campsites (arrangement for the placement of tents, caravans, provisional boxes, etc.)	The number of persons at the same time may be specified according to the number of accommodation places plus staff allowance.		according to remarks		5	
4	Rooms with various functions/destinations at stadiums/arenas	According to the classification “rooms specific to several functions/destinations of civilian buildings”, destinations/functions in the different buildings or assimilation to existing ones.					

**Table 38: Maximum number of persons in underground buildings at the same time**

Underground buildings	According to the classification of buildings with different functions/destinations of which they are composed.
-----------------------	--

**Table 39: Minimum number of persons simultaneously in production and/or storage buildings**

Reference No	Destination/operation	Remarks	Reference level	Useful area (m <sup>2</sup> )/pers.	Destination /function of the area considered in the calculation	Increment [%]	Staff to whom increment is granted
1	Production site	Permanent staff established by the project for an exchange of work		5.00 (or according to remarks)			
2	Warehouse/storehouse/store room	Permanent staff determined by the project		30.00 (or according to remarks)			
3	Rooms with various functions/destinations	According to the classification “rooms specific to several functions/destinations of civilian buildings”, destinations/functions in the different buildings or assimilation to existing ones.					

**Table 40: Minimum number of persons at the same time in rooms specific to several functions/destinations of civilian buildings**

<b>Ref ere nce No</b>	<b>Destination/operation</b>	<b>Useful area (m<sup>2</sup>)/pers.</b>	<b>Incre ment [%]</b>	<b>Staff to whom increment is granted</b>
1	Premises for commerce, administration, art/culture, villages, education, tourism, sport, etc.	According to the specific areas listed in the previous paragraphs or to those observations	According to previous classifications	
2	Workshop	5.00 to 7.00	5	Administrative staff, etc.
3	Bank	5.00	10	Service, administrative staff, etc.
4	Lobby	5.00	10	Service, administrative staff, etc.
5	Staff/changing rooms (and social-sanitary rooms) with self-service cabinets or racks or guard systems	Number of cabinets or number of workers in maximum exchange	-	Possible programme overlaps
6	Studio (radio, tv, etc.)	3.00	20	Public or visitors, foreigners, etc.
7	Waiting area (airport, bus stations, etc.)	4.00	5	Security, administrative staff, etc.
8	Reception area	8.00	5	Service, administrative staff, etc.
9	Kitchen	6.00	-	Chefs, bartender, waiters, etc.
10	Production site	Number of workers in maximum exchange	-	-
11	Warehouse/storehouse/store room	- (or permanent staff determined by the project)	-	-
12	Common bedrooms/home rooms	Number of beds		
13	Stadiums and galleries	In accordance with specific legislation		

(2) In the case of construction works for which the legislation does not contain provisions necessary to determine the simultaneously maximum number of persons, the designer shall determine the maximum number of persons in each individual room.

(3) The maximum number of persons simultaneously shall be stated in the technical design documentation on each room, level and on the whole building.

### **2.5.10. Standardised user number ( $U_f$ ) for escape passage (flows) units**

**Article 2.5.10.1.** The standardised number of users per escape passage unit ( $U_f$ ) from constructions of normal heights are specified according to the intended use of the construction or part of the construction from which users are evacuated, according to the standard provisions.

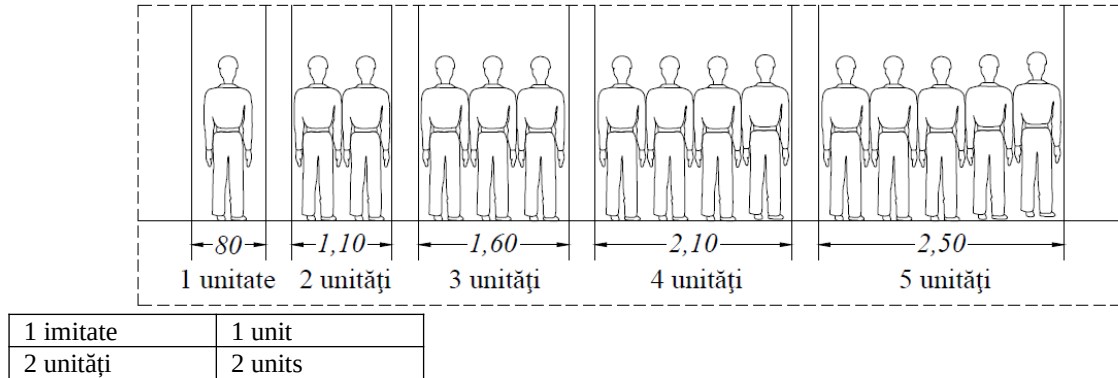
### **2.5.11. Escape passage (flows) units**

**Article 2.5.11.1. (1)** The standardised clear width for escape pass-through units (streams) is (according to Figure 60 and Figure 61):

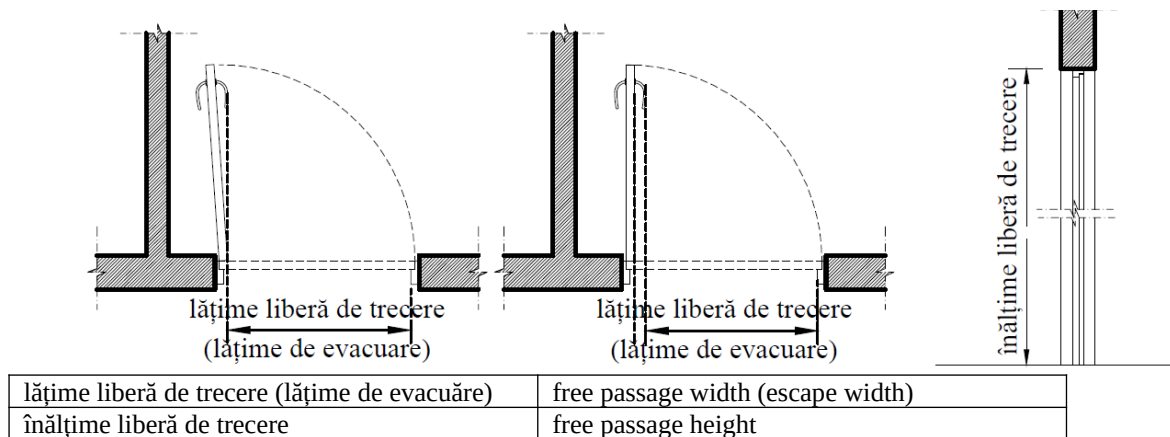


- a) 80 cm for an escape passage (flow) unit;
- b) 1.10 m for two escape passage (flows) units;
- c) 1.60 m for three escape passage (flows) units;
- d) 2.10 m for four escape passage (flows) units;
- e) 2.50 m for five escape passage (flows) units.

(2) Intermediate widths of the passage units resulting from the calculation are considered valid for passing the lower number of passage (flows) units.



**Figure 60 - Standard widths of escape passage (flows) units and free widths of escape doors corresponding to the number of flows**



**Figure 61 – Free escape doors widths and heights**

### 2.5.12. Determination of the number of escape passage (flows) units

**Article 2.5.12.1. (1)** In determining the escape passage (flows) units in the event of fire, regard shall be given to the construction as a whole, ensuring that the most severe escape conditions are met when the escape routes are common to several distinct functions and, where appropriate escape routes are provided for a function, the standard conditions for that function shall be ensured.

(2) The number of escape passage (flows) units to be ensured for the escape of users of a construction shall be determined with the relationship

$$UT = N : U_f$$

where:

**UT** = number of escape passage (flows) units;

**N** = number of users to evacuate;

**U<sub>f</sub>** = the standardised number of users per escape passage (flow) unit.

(3) The results shall be rounded to the nearest whole number.

(4) Number of users (**N**) for which the escape passage (flows) units are calculated is represented by the maximum simultaneous capacity of users of the construction, its levels and the rooms, according to the provisions of the Rule.

(5) The standardised number of users per escape passage (flows) unit (**U<sub>i</sub>**) of buildings of normal heights shall be determined according to the standardised provisions (according to their functions or types of building for civil buildings, as well as to **Article 3.1.5.6.** and Table 51) and according to **Article 6.1.5.15.** and Table 115 for construction of production and/or storage).

(6) The standardised number of users per escape passage (flow) unit (**U<sub>i</sub>**) in high, very high buildings or buildings with very crowded rooms is the one laid down in their specific provisions.

**Article 2.5.12.2. (1)** Regardless of the number of escape passage units (flows) resulting from the calculation, exits to the outside the building (external doors) cannot be reduced.

(2) In buildings with crowded rooms as well as those whose maximum simultaneous capacity is greater than **3 500** persons in order to mitigate the consequences of the panic effect, the number of escape flows to the outside the building passing through the doors that constitute the main access to the building by the public or visitors (persons who do not know the building) shall be increased by multiplying it by a minimum coefficient **1.25**.

### ***2.5.13. Determination of the number of escape routes***

**Article 2.5.13.1.** In constructions, the number of escape routes shall be determined according to the determined need to evacuate the escape passage (flows) units in the event of fire, taking into account the level of fire stability, the fire risk, the type of construction and its destination, in conjunction with the provisions of **Article 2.5.3.1.**

### ***2.5.14. Length of escape path***

**Article 2.5.14.1. (1)** The length of the escape path for the construction users (Figure 62) shall be determined on the route to be travelled – at the centre of the escape routes, from the point of departure of the user to the nearest escape door (directly outside, access to an escape staircase, buffer room or access room to a protected clearance), or the first step of the open stairway, taking into account the position of different equipment or objects with fixed location or furniture and which shall be bypassed, as follows:

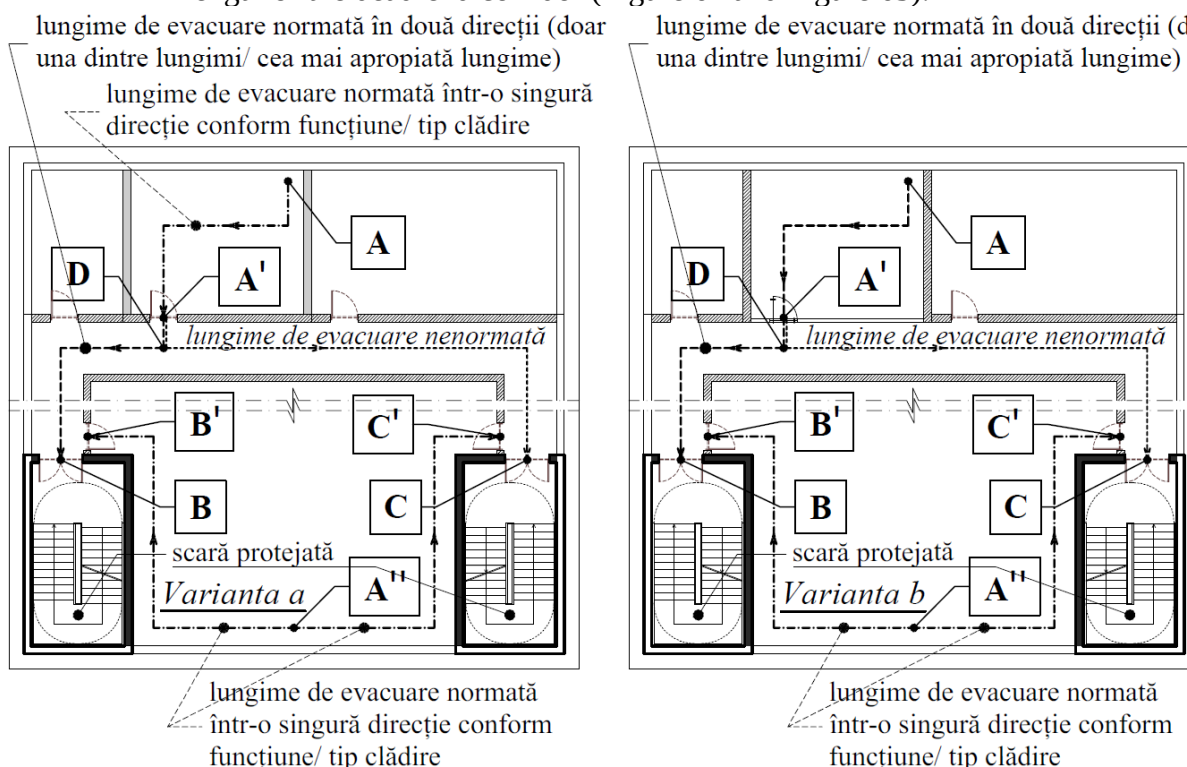
1. The length on the escape routes shall be measured horizontally, in the axis of the traffic and escape routes and in the shortest direction (only one of the length of the escape path shall meet the standard conditions) when the evacuation is made to two distinct and independent directions (at an angle greater or equal to **90°**), from the farthest place (e.g. room door provided in the fire resistant escape corridor according to the standard conditions in which the interior of the room does not exceed the length of the dead-end corridor) to the door of the stairway, protected clearance or buffer room protected by access to the nearest escape staircase or a door/exit directly to the outside.

2. The length within the open space shall be measured horizontally, in the axis of the traffic and escape routes and in the shortest direction (only one of the length of the escape path shall meet the standard conditions) when the evacuation is made in two distinct and independent directions (at an angle equal to or greater than **90°**), from the farthest place to the door of the staircase, protected release or buffer room protected by access to the nearest escape staircase or a door/exit directly to the outside.

The directional changes along the route (inside the rooms) shall be carried out at angles with degrees depending on the axis of the escape paths.

(2) The following shall be considered:

- a) A dead-end corridor less than the normal length for each operation/building type, measured by an escape path (corridor) with access to two stairways, buffer rooms, protected release rooms or exits in opposite directions (escape in 'T', at an angle  $\alpha$  of  $180^\circ$ ), it is considered to be a permissible escape path if the total distance from the point of departure to a staircase, buffer room, protected clearance or outlet outside does not exceed the length of escape in two directions and the distance to be travelled in the same direction does not exceed the length of the dead-end corridor.
- b) Inside open spaces, the length measured to the nearest access door to two stairways, protected escape, buffer rooms or exits located in distinct and independent directions (escape in 'Y', at an angle  $\alpha$  greater than or equal to  $90^\circ$ ), shall be considered as a permissible escape path if the total distance of the to the nearest staircase access door, protected clearance, buffer room or outlet is not greater than the standardised length in two directions and the distance to be travelled in the same direction from the point of departure to the inflection point does not exceed the length of the dead-end corridor (Figure 62 and Figure 63).
- c) On escape corridors, the length measured from a room door provided in the fire resistant walls of the corridor to an escape path with access to two stairways, protected clearance, buffer rooms or exits located in distinct and independent directions (at an angle equal to or greater than  $90^\circ$ ), is considered to be a permissible escape path if the total distance to the nearest access door to the staircase, protected clearance, buffer room or outlet outside does not exceed the standardised length in two directions and the distance to be travelled in the same direction from the point of departure to the inflection point does not exceed the length of the dead-end corridor (Figure 62 and Figure 63).



lungime de evacuare normală în două direcții (doar una dintre lungimi/ cea mai apropiată lungime )	standardised escape length in two directions (only one of the lengths/nearest length)
lungime de evacuare normală într-o singură direcție conform funcțiune/ tip clădire	normal escape length in one direction according to operation/building type
<i>lungime de evacuare nenormată</i>	<i>non-standardised escape length</i>
scară protejată	protected staircase
<i>Varianta a</i>	<i>Variant a</i>
lungime de evacuare normală într-o singură direcție conform funcțiune/ tip clădire	normal escape length in one direction according to operation/building type

**In the axis of the corridor from point A', a fire-resistant wall is provided (and a door, according to standardised provisions)**

**Provided that  $(AA') < l$**

**$(A'D) + (BD)$  or  $(A'D) + (CD) \leq L$  (requires a second direction of point D with an angle of min. 90°)**

**Distances (to the corridor doors) provided from point A'',  $(A''B') < l$  and  $(A''C') < l$**

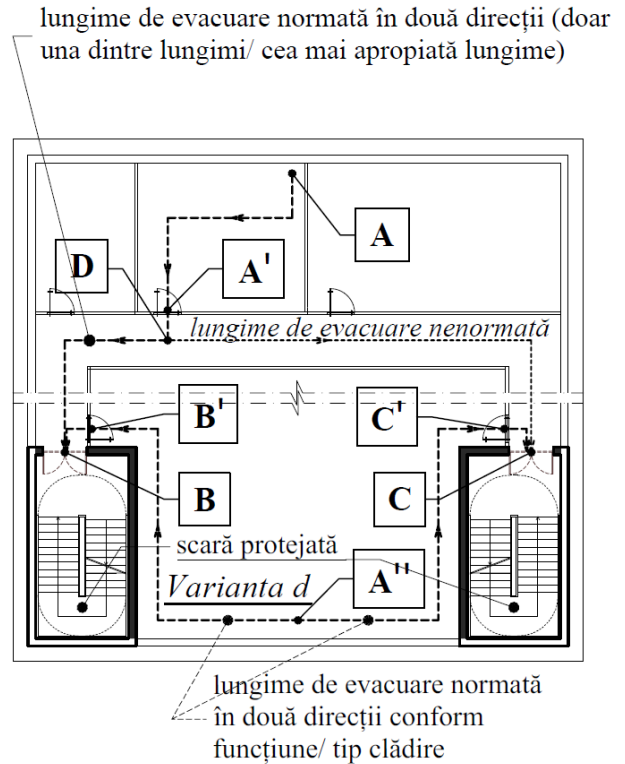
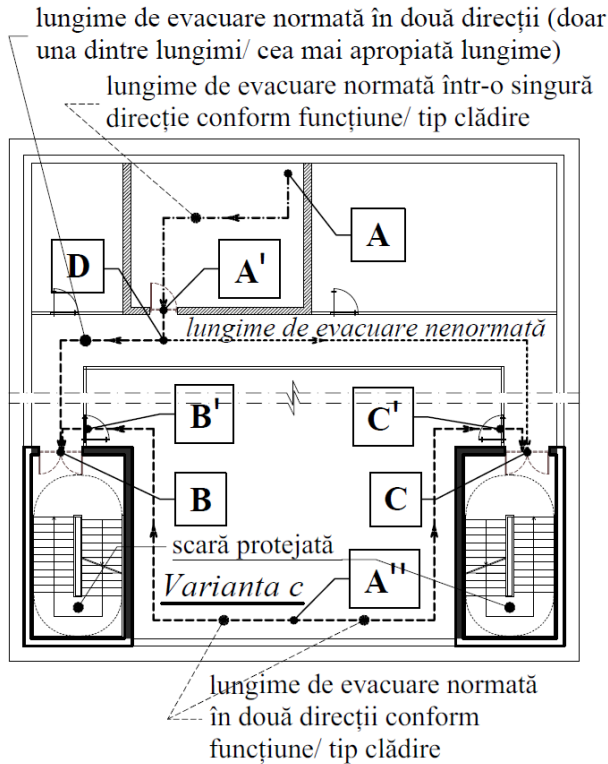
**No fire resistant wall is provided in the axis of point A'**

**If  $(AA') \geq l$ , not allowed**

**Provided that  $(AD) < l$**

**$(AD) + (BD)$  or  $(AD) + (CD) \leq L$  (requires a second direction of point D with an angle of min. 90°)**

**Distances (to the corridor doors) provided from point A'',  $(A''B') < l$  and  $(A''C') < l$**



lungime de evacuare normată în două direcții (doar una dintre lungimi/ cea mai apropiată lungime)	standardised escape length in two directions (only one of the lengths/nearest length)
lungime de evacuare normată într-o singură direcție conform funcțiune/tip clădire	standardised escape length in one direction according to operation/building type
lungime de evacuare nenormată	non-standardised escape length
scară protejată	protected staircase
Variantă c	Variant c
lungime de evacuare normată în două direcții conform funcțiune/ tip clădire	standardised escape length in two directions according to operation/building type

**In the axis of the corridor from point A', a fire-resistant wall is provided (and a door, according to standardised provisions)**

**Provided that  $(AA') < l$**

**$(A'D) + (BD)$  or  $(A'D) + (CD) \leq L$  (requires a second direction of point D, with an angle of min. 90°)**

**Distances (to the staircase doors) provided from point A'',  $(A''B) \leq L$  and  $(A''C) \leq L$**

**No fire resistant wall is provided in the axis of point A'**



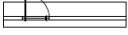
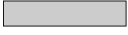
**If  $(AA') \geq l$ , not allowed**

**Provided that  $(AD) < l$**

**$(AD) + (BD)$  or  $(AD) + (CD) \leq L$  (requires a second direction from point D, with an angle of min. 90°)**

**Distances (to the staircase doors) provided from point A'',  $(A''B) \leq L$  and  $(A''C) \leq L$**

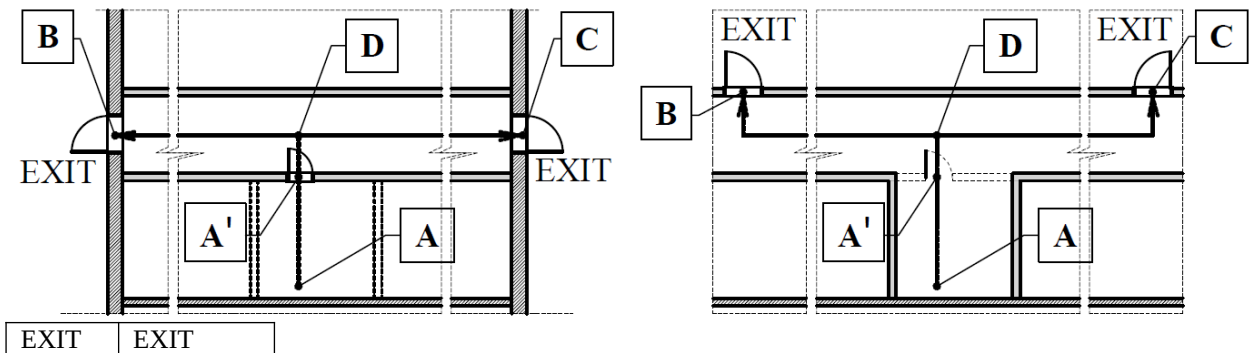
LEGENDĂ:

-  -pereți rezistenți la foc conform condiții de separare coridoare, raportat la funcțiune/ tip clădire
-  -pereți rezistenți la foc conform condiții de separare scări, raportat la funcțiune/ tip clădire
-  -compartimentare funcțională (fără rezistență la foc), raportat la nivelul de stabilitate la incendiu
-  -pereți rezistenți la foc conform condiții de separare minimum pereți neportanți despărțitori interiori cu rol de limitare a propagării focului (sau conform destinație sau densitate de sarcină termică), raportat la funcțiune/ tip clădire

LEGENDĂ:	LEGEND:
-pereți rezistenți la foc conform condiții de separare coridoare, raportat la funcțiune/ tip clădire	- fire resistant walls according to corridor separation conditions, relative to operation/building type
-pereți rezistenți la foc conform condiții de separare scări, raportat la funcțiune/ tip clădire	- fire resistant walls according to stairway separation conditions relative to operation/building type
-compartimentare funcțională (tară rezistentă la foc), raportat la nivelul de stabilitate la incendiu	- functional partition (fire resistant tare) relative to the fire stability level
-pereți rezistenți la foc conform condiții de separare minimum pereți neportanți despărțitori interiori cu rol de limitare a propagării focului (sau conform destinație sau densitate de sarcină termică), raportat la funcțiune/ tip clădire	- fire resistant walls according to minimum separation conditions for internal non-partition walls limiting fire propagation (or according to destination or thermal load density) relative to operation/building type

**Figure 62 - Escape (principles)**

Note **Figure 63** 'L' indicates the maximum length of the escape path in two directions; 'l' indicates the maximum length of the escape path in one direction



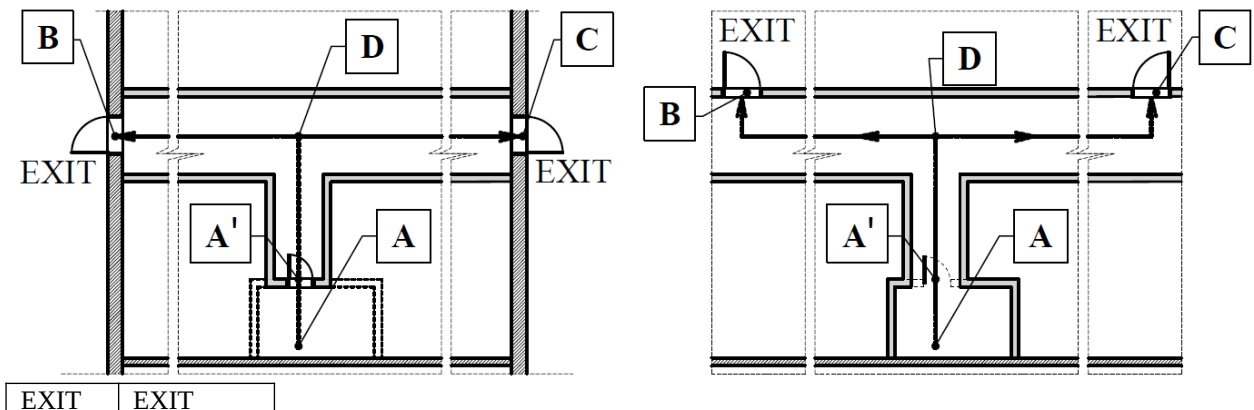
*In the axle of point A', a wall with resistance to fire (and door according to standard provisions) shall be provided.*

*If  $(AA') < l$   
 $(A'D) + (BD)$  or  $(A'D) + (CD) \leq L$*

*Variant a) – classical escape on corridors*

*No fire resistant wall is provided in the axis of point A'*

*If  $(AA') \geq l$ , not allowed  
 Maximum Allowable  $(AD) < l$   
 $(AD) + (BD)$  or  $(AD) + (CD) \leq L$*



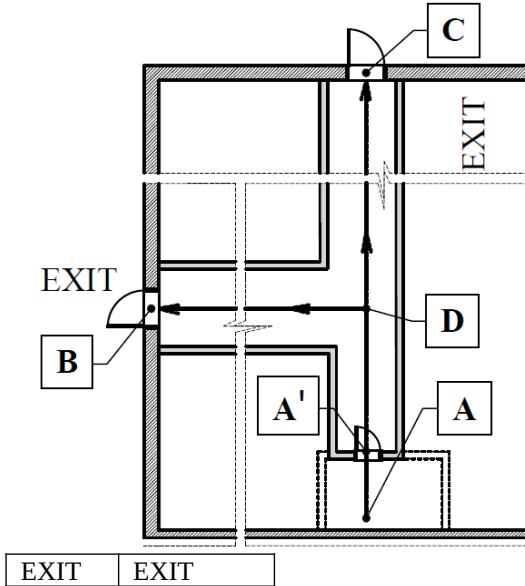
**In the axis of point A', a wall with resistance to fire (and door according to standard provisions) shall be provided.**

**If  $(AA') < l$**

**$(A'D) + (BD)$  or  $(A'D) + (CD) \leq L$**

**Provided that  $(A'D) < l$**

**Variant b) – escape 'in T' on corridors**

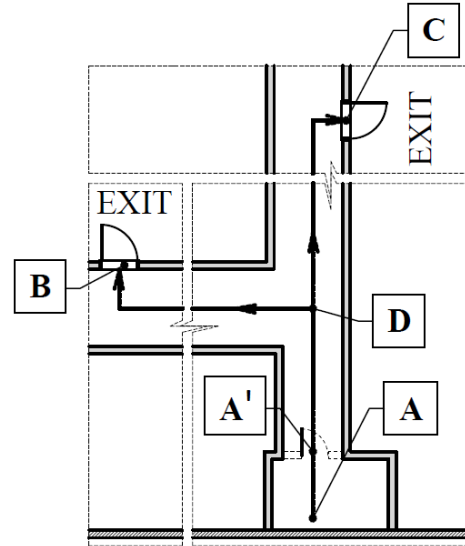


**No fire resistant wall is provided in the axis of point A'**

**If  $(AA') \geq l$ , not allowed**

**Maximum Allowable  $(AD) < l$**

**$(AD) + (BD)$  or  $(AD) + (CD) \leq L$**



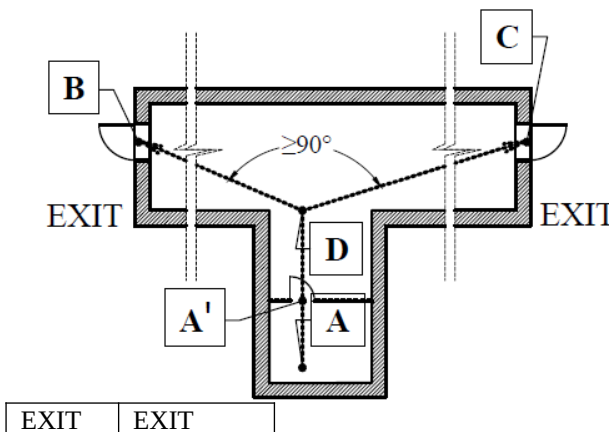
**In the axis of point A', a wall with resistance to fire (and door according to standard provisions) shall be provided.**

**If  $(AA') < l$**

**$(A'D) + (BD)$  or  $(A'D) + (CD) \leq L$**

**Provided that  $(A'D) < l$**

**Variant c) – escape 'in Y' (with an angle of 90 degrees or more) on corridors**

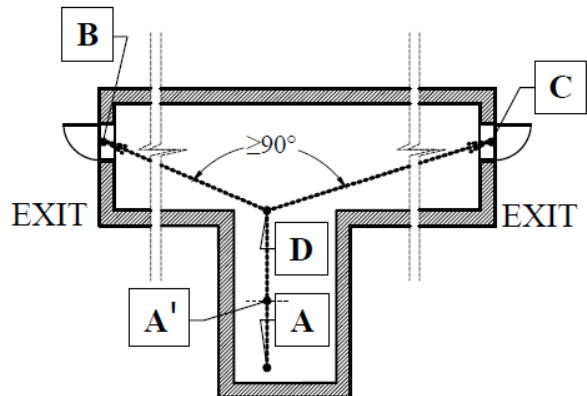


**No fire resistant wall is provided in the axis of point A'**

**If  $(AA') \geq l$ , not allowed**

**Maximum Allowable  $(AD) < l$**

**$(AD) + (BD)$  or  $(AD) + (CD) \leq L$**



**In the axis from point A', there is at least a partition wall with fire resistance (and a door according to standard provisions)**

**If  $(AA') < l$**

**$(A'D) + (BD)$  or  $(A'D) + (CD) \leq L$**

**Provided that  $(A'D) < l$**

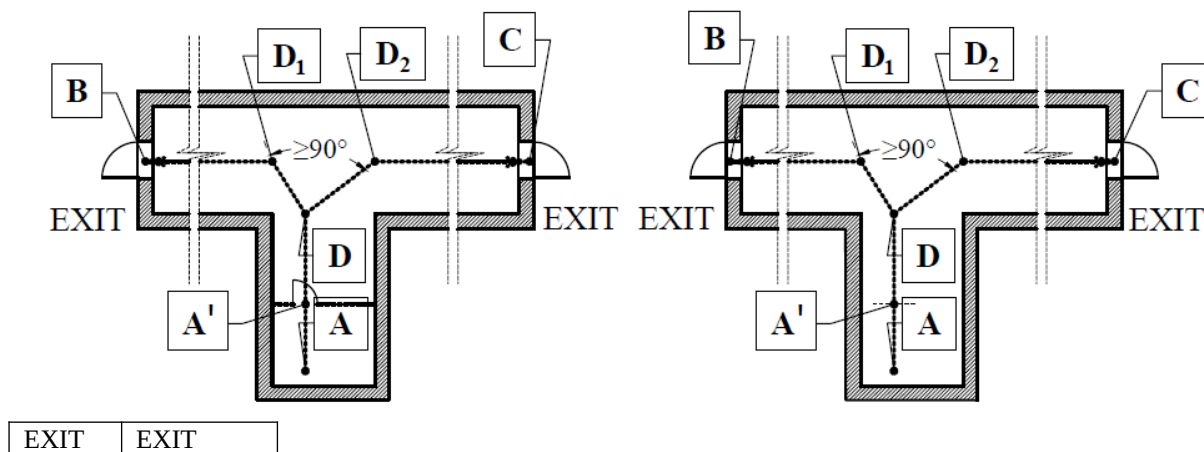
**Variant d.1) – escape 'in Y' (with an angle of 90 degrees or greater) inside the open space**

**In the axis at point A', there is no minimum partitioning wall with fire resistance**

**If  $(AA') \geq l$ , not allowed**

**Maximum Allowable  $(AD) < l$**

**$(AD) + (BD)$  or  $(AD) + (CD) \leq L$**



*In the axis from point A', there is at least a partition wall with fire resistance (and a door according to standard provisions)*  
 If  $(AA') < l$   
 $(A'D) + (DD_1) + (BD_1)$  or  $(A'D) + (DD_2) + (CD_2) \leq L$   
 Provided that  $(A'D) < l$

*In the axis at point A', there is no minimum partitioning wall with fire resistance*  
 If  $(AA') \geq l$ , not allowed  
 Maximum Allowable  $(AD) < l$   
 $(AD) + (DD_1) + (BD_1)$  or  $(AD) + (DD_2) + (CD_2) \leq L$

**Variant d.2) – escape ‘in Y’ (with an angle of 90 degrees or greater) inside the open space**

Note Figure 64: ‘L’ indicates the maximum length of the escape path in two directions; ‘l’ indicates the maximum length of the escape path in one direction

**Figure 63 - Escape (length calculation – examples)**

(3) The following requirements shall be taken into account when determining the escape length in open spaces divided by furniture and/or bulk walls, opaque or glazed panels, fixed or movable, used as functional separation and/or sound insulation:

- a) the length of the escape path shall be calculated from the furthest point of the open spaces to the entrance to a protected space (protected buffer room, protected clearance, escape staircase, etc. or directly to the outside) taking into account separation panels and fixed furniture;
- b) in the case of open stairways (only where the Rule provides), the escape length shall be masked up to their first step;

**Article 2.5.14.2.** Depending on the intended use (function) of the construction and the level of fire stability provided, the length of the users’ escape routes shall comply with the provisions on performance specific to the use and type of building.

**Article 2.5.14.3. (1)** The length of escape of users in the event of fire on escape routes shall be standardised according to the level of fire stability of the construction and the safety measures provided to users in the event of fire, and shall be specified in the technical design documentation.

(2) When determining the length of the escape path, the distances travelled shall not be taken into account:

- a) on escape staircases as well as inside protected fences, protected buffer rooms ventilated under excess pressure and protected tunnels (protected tunnels/openings with a maximum length of **200 m**);
- b) inside rooms in which the permissible escape length for funnelled corridors is not exceeded.

(3) The length of the escape path inside the enclosed staircases (on the common horizontal path within it) as well as in the escape stairway access buffer rooms (where these are foreseen) shall not exceed the length for the dead-end corridor.

**Article 2.5.14.4. (1)** In mixed-function constructions with different destinations arranged in separate areas of construction, the lengths of escape routes shall fulfil the performance corresponding to each function.

**(2)** When escape routes are common to several or all destinations under construction, the layout, dimensioning and composition of the escape routes shall meet the most severe performance conditions of the destinations for which users are evacuated.

## **2.5.15. Escape routes gauges**

### **2.5.15.1. Standardised escape routes widths**

**Article 2.5.15.1.1. (1)** The standard clear width for escape routes is that set in **Article 2.5.11.1** and according to Figure 60 and Figure 61.

**(2)** Intermediate widths of the pass-through units resulting from the calculation are considered valid for passing the lower number of drainage units (streams).

**Article 2.5.15.1.2. (1)** The gross (unfinished) dimensions of doors and escape stairways shall be determined in such a way that the free space required for the passage of the number of escape passage (flows) units is not reduced locally by more than **10 cm** in height (door) not exceeding **2.10 m** from the elevation of the floor (through projections of walls, frames, linings, door or window grooves in the open position, internal finishes, installations, etc.). Reducing the width of the clearance required to pass the number of escape passage (flows) units is not permitted.

**(2)** Width of escape routes for more than **50** persons shall not be reduced in the sense of outward movement and escape, even if it is greater than the width resulting from the calculation, with the exceptions laid down in the Rule.

**(3)** The width of the ramps and floors of stairways shall be measured between the horizontal projection of the delineating elements (handrails, bulwarks, walls and handrails/bulkheads).

**4.** Free (unenclosed) niches shall be permitted in the walls of corridors and stairways, with a bulwark more than **1.20 m** above the floors and free niches with their upper edge not more than **90 cm** floor coverings.

**(5)** The clear width of corridors, ramps and stairway floors evacuating users shall not be reduced by doors or windows opening to them, except for windows with a bulwark greater than **2.10 m** above the level of the floor or steps next to them, as well as doors that can be folded down at the wall (hinged doors).

**(6)** Where there is a higher level difference of **20 cm** floors shall be provided between the elevation of the escape path and that of the terrain in front of the escape doors directly to the outside of the building, having a width not less than twice the width of the door and a minimum depth of the width of the door.

**(7)** In front of the doors of passenger lifts in staircases, the width of the landing of the staircase shall be at least **1.60 m** if the sliding doors of the lifts are open on hinges and not less than **1.20 m** when the doors of lifts are sliding.

**(8)** Escape stairway ramp width greater than **2.50 m** between walls or between walls and handrails or between two handrails, split by intermediate handrails. It is not mandatory to provide intermediate handrails at:

- a)** stairway ramps used to reach the exit;
- b)** stairway ramps at least twice as wide as required by escape passage (flows) units;
- c)** ramps of internal or external monumental stairs.

### **2.5.15.2. Clearance heights on escape routes**



**Article 2.5.15.2.1. (1)** The clearance height of escape routes of constructions users shall be at least **2.10 m**, with the exceptions provided for in the Rule and specific technical regulations.

**(2)** Building attics and subsoils may have a minimum clear height of **1.90 m** and technical basements of **1.80 m**.

### **2.5.16. Marking of escape routes**

**Article 2.5.16.1. (1)** The routes of escape routes of users of a building shall be marked with signs, according to the provisions of the specific technical regulations.

**(2)** In case of continuation of overground escape staircases below ground level, measures shall be taken to signal the escape path towards the outlet.

**(3)** Safety lighting for escape and circulation shall be provided on the escape routes of building users, according to the provisions of the relevant technical regulations.

## **SECTION VI**

### **2.6. Conditions for access, intervention and rescue in the event of fire**

**Article 2.6.1. (1)** Constructions, as well as outdoor installations, shall be provided with the necessary external roadway routes (roads, platforms, etc.), so as to ensure the necessary conditions for action and rescue in the event of fire.

**(2)** Roads passing over underground buildings (basements, canals, galleries, etc.) shall be accessible to all intervention vehicles.

**(3)** Where the construction or installation does not require functional external roadways, unobstructed strips of terrain may be provided to allow access to fire response vehicles.

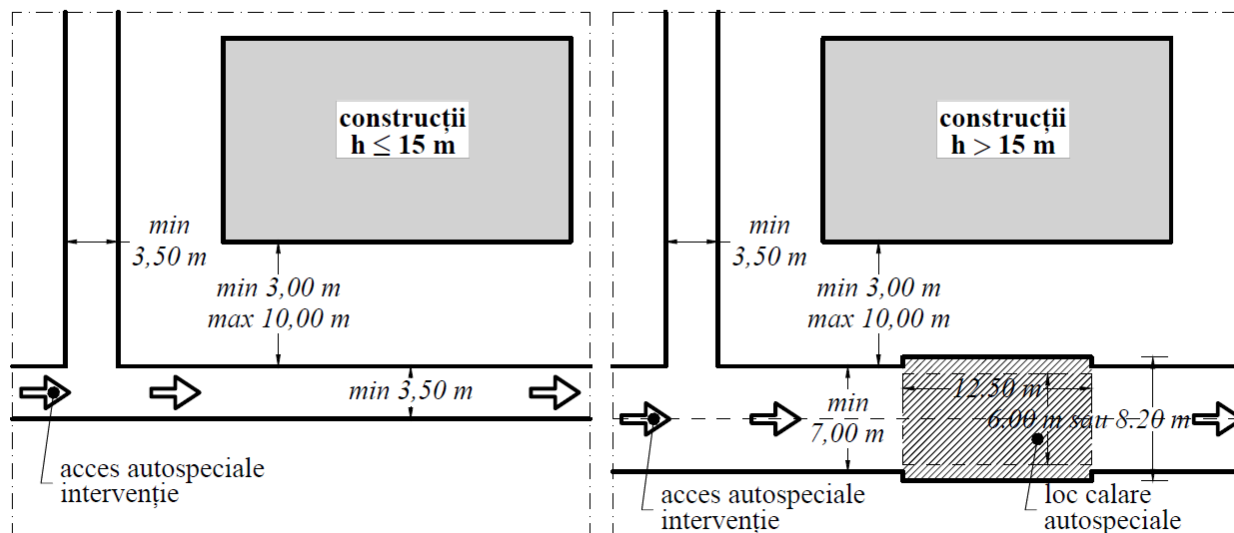
**(4)** It is not mandatory to provide outdoor roads or strips of terrain that give access to fire response vehicles to mountain or Danube Delta buildings, which are located in isolation and to household attachments.

**(5)** Private utility roads shall be according to the technical characteristics of the intervention vehicles in the emergency inspectorates to which they belong and shall be provided with sections for the stairway stairways that are also in conformity with the technical characteristics of the tower cars in which they are fitted to the emergency inspectorates to which they belong, in relation to the height of the buildings. It shall be ensured that the conditions required by the use of tower cars and fire intervention vehicles are maintained.

**Article 2.6.2.** The constructions shall provide access to intervention vehicles, as follows:

– by means of road traffic with a minimum clear width (gauge) **3.50 m**, for a lane for construction (including single-family/collective housing ensembles) with a rise  **$h \leq 15.00$  m** (measured from the benchmark level to the walkable elevation of the last level used by users) and length/depth of roads accessible to intervention vehicles  $\leq$  **30.00 m** (according to Figure 64 variant **a**);

– by means of road traffic of a clear width (gauge) of at least **7.00 m** to buildings (including multi-dwelling ensembles) with a rise  **$h > 15.00$  m** (measured from the reference level to the walkable elevation of the last level used by the users, according to Figure 64 variant **b**) and Figure 65);



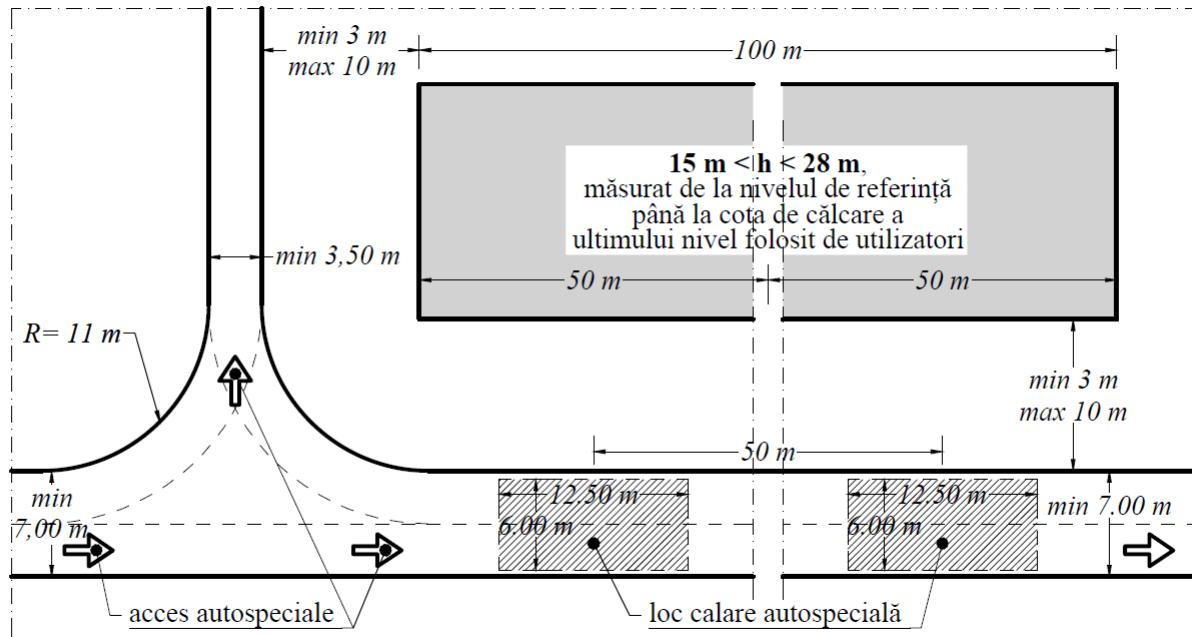
construcții $h \leq 15$ m	constructions $h \leq 15$ m
min 3,50 m	min. 3.50 m
min 3,00 m	min. 3.00 m
max 10,00 m	max 10.00 m
acces autospeciale intervenție	intervention vehicles access
loc calare autospeciale	intervention vehicles stalling spot

**Variant a)** with a rise  $h \leq 15.00$  m (measured from the benchmark level to the walkable elevation of the last level used by users) with length/depth access for vehicles intervention less than 30.00 m

**Variant b)** with a rise  $h > 15.00$  m (measured from the benchmark level to the walkable elevation of the last level used by users)

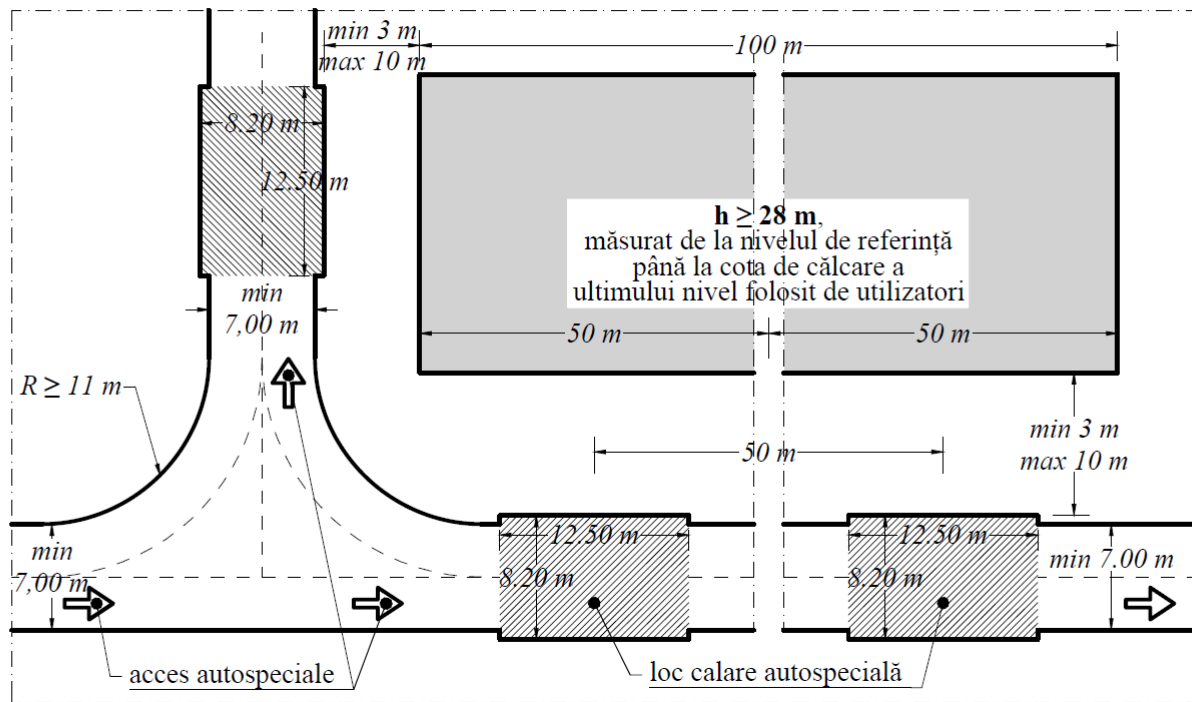
**Figure 64 - Access to intervention vehicles – general case**

- carriageways shall be sized in such a way as to be accessible to the intervention vehicles according to the technical characteristics referred to in **Article 2.6.3**;
- on the path of the intervention vehicle, the free height shall be: minimum **4.20 m**
- minimum distance from construction to the carriageway: **3.00 m**
- maximum distance from construction to road circulation or location of the intervention vehicle: **10.00 m**
- constructions with height  $h \leq 15.00$  m (measured from the reference level up to the walkable elevation of the last level used by users) is not required to be provided with a location for stalling of the intervention vehicle,
- on at least one façade of the building, one area shall be provided for the stalling of the intervention vehicle (at each **50.00 m** linear) with dimension: **6.00 m x 12.50 m** (only for buildings with a height between  $15.00 \text{ m} < h < 28.00 \text{ m}$  measured from the baseline to the walkable elevation of the last level used by users, as shown in Figure 65 variant a);
- on at least two facades of the building, an area shall be provided for the stalling of the intervention vehicle (at each **50.00 m** linear) with dimension: **8.20 m x 12.50 m** (only for constructions with height  $h \geq 28.00 \text{ m}$  measured from the baseline to the walkable elevation of the last level used by users, as shown in Figure 65 variant b);
- in the building premises to which the vehicles have access by means of a barrier point, it shall be provided with automatic opening in the event of fire in all cases where the construction is fitted with a fire detection, signalling and alarm system.
- traffic routes and dead-end access with longer lengths of **100 m** shall have sufficient space to manoeuvre and turn the intervention vehicles (including inside the premises), regardless of the destination and rise of the buildings.
- when within the premises/sites, the road access accessible to the intervention vehicles exceeds the length of **30.00 m**, two lanes of overall width of **min 7.00 m** shall be provided.



min 3 m	min. 3 m
max 10 m'	max. 10 m'
15 m < h < 28 in, măsurat de la nivelul de referință până la cota de călcare a ultimului nivel folosit de utilizatori	15 m < h < 28 in, measured from the benchmark level to the walkable elevation of the last level used by users
acces autospeciale	intervention vehicles access
loc calare autospecială	intervention vehicles stalling spot

**Variant a) to at least one facade of the building (for buildings with height between 15.00 m < h < 28.00 m, measured from the reference level to the walkable elevation of the last level used by users);**



min 3 m	min. 3 m
max 10 m	max. 10 m
h ≥ 28m, măsurat de la nivelul de referință până la cota de călcare a ultimului nivel folosit de utilizatori	h ≥ 28m, measured from the benchmark level to the walkable elevation of the last level used by users

acces autospecială	intervention vehicles access
loc calare autospecială	intervention vehicles stalling spot

*Variant b) at least two façades of the building (for buildings with height  $h \geq 28.00$  m measured from reference level up to the walkable elevation of the last level used by users);*

**Figure 65 - — Access of intervention vehicles to buildings above 15 m in height m (measured from reference level up to the walkable elevation of the last level used by users)**

**Article 2.6.3.** The technical characteristics of the firefighter's vehicles required for the dimensioning of roads and the floors on which they have access, shall be as follows:

- width: **2.55 m**;
- height **4.00 m**;
- minimum turning radius: **11.00 m**
- maximum slope: **30 %**
- maximum mass: **50 000 kg**
- the width of the attachment place to: **8.20 m**
- contact force of the backstay on the road: the vehicle shall be considered as the maximum mass operationalised **50 000 kg** and stalling takes place in **4** points (the area of a backstay is **0.80 MP**)

**Article 2.6.4. (1)** External access and traffic routes must allow for the intervention of vehicles in the event of fire (without obstacles), construction, installations, storage of materials and combustible substances, and access to water supplies.

**(2)** Built-up premises where access from public roads crosses with overground railways or metro lines, two accesses from public roads shall be provided, one of which shall be achieved through an area which does not intersect the above railway or metro track.

**Article 2.6.5. (1)** Internal yards with an area larger than **800 m<sup>2</sup>**, closed on all sides of constructions and situated at the level of adjacent terrain or road movements or with a level difference of no more than **50 cm** above these, there shall be at least one carriageway for fire intervention vehicles, with a minimum gauge **4.00 m** width and **4.50 m** height.

**(2)** Internal yards with the area of **200 m<sup>2</sup>** and **800 m<sup>2</sup>**, closed on all sides of construction and with differences in levels greater than **50 cm** from the level of the land or adjacent road carriageways, pedestrian access shall be provided for fire response personnel, having a minimum clear width of **1.50 m** and minimum clear height of **2.10 m**.

**Article 2.6.6. (1)** In high and very high buildings, outside the curtain walls, there shall be a visible marking of the places where fire response formations can enter the building, using adjacent road surfaces accessible to intervention vehicles.

**(2)** In closed buildings with curtain walls or double façades – double skin, roads shall be horizontal opposite to the facade panels marked for access by emergency personnel in the event of fire.

**(3)** Glazed panels from perimeter closures of curtain walls or ventilated façades and double façades of high and very high buildings (and advisable to all other constructions) through which access to horizontal common paths or into rooms with permanent access to common paths for the intervention of intervention staff directly from the outside can be achieved, shall have the following characteristics:

- height: minimum **1.50 metres**;
- width: minimum **90 cm**;
- distance between successive openings situated at the same level: from **10.00 to 20.00 metres**;
- be arranged on each level of the building starting on the first floor.

- minimum distances of **4 metres** measured in the horizontal projection of the facade between the moving meshes on a level and those of the levels immediately above and below, except for those with access to common horizontal traffic routes;
- obturation panels or frames of movable meshes shall be capable of opening/breaking and shall always remain accessible from the outside and from the inside. They must be easily visible from the outside by the intervention services.

**Article 2.6.7. (1)** Compared to the minimum number of façades accessible and properly accessed through streets or open spaces according to the standardised provisions (according to operation or type of building), the following conditions should also be met:

a) for buildings with more than **3 500** persons: shall have two façades served by two routes or recommended by three façades, and the following two conditions shall always be met:

- 1) the length of facades accessible to the intervention vehicles shall be greater than **50 %** of the perimeter of the building;
- 2) it shall be possible to provide access to the floor level directly from the outside by means of intervention teams using a rescue vehicles from a tower car by means of appropriately marked panels or windows that can open or break easily and through which the communal traffic of horizontal or free spaces type of open spaces can be accessed. If this condition cannot be met, the construction must necessarily have three accessible facades distributed throughout its perimeter and served by traffic routes;

b) for constructions between **2 501** and **3 500** persons: must ensure access of intervention teams with rescue vehicles from a tower car to double façade level through open spaces or horizontal common paths. If this condition is not fulfilled, it is advisable to have a third accessible façade served by a route;

**(2)** Regardless of the number of persons, in buildings intended for persons who cannot evacuate themselves (defined according to terminology) provided for in sleeping places, access and intervention of extinguishing vehicles in the event of fire must be ensured, at least on **50 %** from the perimeter of the external walls).

**(3)** It is advisable that in constructions which have a surface area between **15 000 m<sup>2</sup>** and **25 000 m<sup>2</sup>**, access and intervention routes for fire intervention vehicles be ensured, at least in full or on two **(2)** adjacent sides and on the third side in part, and at least on **75 %** of the perimeter of the external walls, and for constructions with a developed area larger than **25 000 m<sup>2</sup>**, access and intervention routes for fire intervention vehicles must be ensured, fully on all sides, on **100 %** of the perimeter of the external walls.

**Article 2.6.8. (1)** Temporary or permanent facilities or parking or garage spaces for other motor vehicles shall not be permitted at the entrance to buildings and the designated areas for intervention fires, as well as to places marked for the location and supply of water to intervention vehicles.

**(2)** The functional, escape and intervention routes in the event of fire inside buildings shall be marked in such a way as to be easily recognisable and usable in the event of fire.

**(3)** Fixed connections relating to the extinguishing installations provided for according to the specialised regulations shall consider the maximum connection of the intervention vehicles **40.00 m** in relation to this, in all situations where an automatic extinguishing installation is foreseen. In the event of the supply of intervention vehicles directly from the water pool through absorption by means of semi-rigid tubes, a maximum distance from the connection of **6.00 m**.

## SECTION VII

### 2.7. EQUIPPING BUILDINGS WITH FIRE-FIGHTING SYSTEMS AND MEANS, EMERGENCY SERVICE

**Article 2.7.1. (1)** The structures shall be equipped with fire-fighting systems and means, as well as fire detection, signalling and alarm systems, according to the provisions of the technical regulations.

**(2)** The fitting with extinguishing systems and/or fire detection, signalling and alarm installations of existing buildings in which these installations are not mandatory (such as works carried out on existing buildings, where it is justifiably technically impossible to comply with certain provisions of the Rule), may constitute a compensatory protection measure within the meaning of the provisions of **Article 1.1.4. paragraph 2**.

**Article 2.7.2.** Civil buildings shall be equipped with extinguishers, according to the Rule and specific regulations.

**Article 2.7.3.** The emergency service shall be provided for in the situations set out in the specific regulation.

## CHAPTER 3

### 3. PERFORMANCE SPECIFIC TO FUNCTIONS OF ABOVE GROUND CONSTRUCTIONS OF ORDINARY HEIGHTS

#### SECTION I

##### 3.1. Common provisions

###### ***3.1.1. General construction performance conditions (fire risk, fire stability level)***

**Article 3.1.1.1. (1)** Civil (public) rooms, spaces and buildings shall have fire risks, according to the provisions on common performance in this Rule.

**(2)** Depending on the fire risks determined, the classes and levels of fire performance provided for in **Chapter 3 – Specific performance** and to **Chapter 2 – Joint performance** in constructions for any purpose.

**(3)** The fire risks and the risks of volumetric explosion of rooms, zones, fire compartments and buildings shall be mandatory in the technical documentation.

**(4)** Civil (public) buildings shall have the required fire stability level specified in the design documentation. The minimum requirements to be met by the building for a certain level of fire stability are laid down according to the provisions of **Article 2.1.3.2** and Table 2.

###### ***3.1.2. Location and compliance of buildings***

**Article 3.1.2.1.** Civil constructions of normal heights shall comply, be carried out and subdivision, according to the provisions of the Rule.

**Article 3.1.2.2.** Civil constructions with normal above-ground heights shall be placed according to the provisions of the Rule.

**Article 3.1.2.3.** Where several destinations are pooled in a civil building, they shall usually be properly separated by fire resistant walls and floors according to the Rule.

**Article 3.1.2.4.** The merging with other constructions or between them of higher and/or very high civil buildings shall be prohibited within the same fire compartment.

**Article 3.1.2.5. (1)** Compliance shall take into account the provisions on common and specific performances.

**(2)** Above-ground civil constructions with normal heights shall conform in such a way as to meet the requirements for correlation between the fire stability level provided (as required by the provisions of **Article 2.1.3.2** and Table 2), built-up area (**Ac**), destination and number of levels, as provided for in **Article 3.1.2.6.** and **Article 3.1.2.7.** and Table 41 and Table 42.

**(3)** As far as possible, activities with high and very high fire risks shall be carried out in separate areas of construction.

**(4)** The layout of rooms and areas at risk of volumetric explosion in above ground civil building basements is not recommended. Such risks can only be provided in the basement of these constructions when it is technically justified and provided for specific protective measures and partitioned with fire and explosion resistant elements.

**(5)** The handling, processing or storage of materials and substances of a volumetric explosion risk or the placing of workshops in which such materials are used shall not be permitted in above-ground or underground civil constructions, with the exception of those established according to the provisions of the Rule and those with the functions of laboratories, pharmacies, hospitals, etc.

**(6)** For activities at risk of volumetric explosion arranged technically or functionally at all levels of construction (including on the terrace of the last level of civil buildings), it is mandatory to ensure appropriate partitioning measures to other areas and functions with elements resistant to fire and volumetric explosion, according to the applicable provisions of the Rule and technical regulations.

**Article 3.1.2.6.** Depending on the level of fire stability provided, built-up areas of buildings and civil above-ground fire compartments (**Ac**) shall comply with the provisions of Table 41 **and Article 3.1.2.7.**

**Table 41: Conditions for correlation of built areas (Ac) of civil above-ground buildings and fire compartments to the level of fire stability**

<i>Fire stability level</i>	<i>Maximum built area (Ac) of civil above-ground buildings and fire compartments (m<sup>2</sup>)</i>	
	<i>with one level</i>	<i>multilevel</i>
<b>I - II</b>	<b>3,500</b>	
<b>III</b>	<b>2,500</b>	
<b>IV</b>	<b>2,000</b>	<b>1,500</b>
<b>V</b>	<b>1,000</b>	<b>800</b>

Notes:

- a) Where automatic fire detection, signalling and alarm facilities with total coverage are provided, built areas may increase by 25 % (excluding high and very high buildings).
- b) Where automatic fire detection, signalling and alarm systems with total cover and automatic sprinkler fire-extinguishing systems are provided, the built areas may be increased by 100 % for fire buildings/divisions classified with the fire stability level **III, IV** or **V**.
- c) In the case of buildings classified with the fire stability level **I** (excluding high and very high buildings), or **II** where fully covered fire detection, signalling and alarm installations,

automatic fire extinguishing and smoke exhaust systems from horizontal common paths (corridors/halls) and staircases are provided, the built area is not limited.

d) By way of exception to point (a), the built-up areas ( $A_c$ ) of high and/or very high buildings which are not required to be equipped with automatic extinguishing systems according to the profile standard may be increased by 50 % in the case of high buildings or with 25 % in the case of very high buildings when equipped with sprinkler fire-fighting systems, in addition to the provisions of Rule P118: 2.

e) Increases shall not be cumulated.

**Article 3.1.2.7.** Civil above-ground buildings shall comply with the following conditions for correlation between the level of fire stability provided, the number of above-ground levels, the destination and the simultaneous maximum capacity of users:

a) in those with fire stability level **I**, the number of above-ground levels is not limited, regardless of their destination and capacity;

b) in those with fire stability level **II**, the number of above-ground levels corresponds to above-ground constructions of normal heights (not to cause them to be classified in high or very high buildings within the fire stability level **I**);

c) in those with fire stability level **III**, **IV** or **V**, the number of above-ground levels is limited depending on the destination and the simultaneous maximum capacity of users, as set out in Table 42.

**Table 42: Conditions for correlation between destination, simultaneous maximum capacity and number of above-ground levels of civil buildings with fire stability level III, IV or V**

Reference No	Above-ground civil constructions for:	Maximum simultaneous capacity (users)	Maximum number of permissible above-ground levels for civil buildings with fire stability level:		
			III	IV	V
1	1. Buildings intended for persons who cannot evacuate themselves;	150	2	1	1
2	2a. Museums or exhibitions that do not host particular values and are not crowded rooms;	300	3	2	1
	2b. Temporary accommodation buildings;	200			
	2c. Primary education buildings	480			
	2d. Buildings for secondary and tertiary non-tertiary education;				
3	3. Residential buildings;	200	5	3	2
4	4. Buildings with another destination (without crowded rooms).	300	5	2	1

(1) Notes In cases technically justified by specialists certified according to the law, for the buildings referred to in point 2a, 2b, 2d, 3 and 4, investors/beneficiaries may adopt a single level in addition to the permitted ones, provided that they are equipped with sprinkler fire-fighting systems (or water mist only where they have been tested according to the relevant standards).

(2) In the case of buildings with an individual dwelling destination within the level V of for fire stability, investors/beneficiaries may adopt only one additional level provided they comply with the conditions in brackets specified in Table 2: Minimum conditions for classifying the construction or fire compartment into civil buildings fire stability levels, for fire stability level V.

(3) In the case of buildings intended for temporary accommodation falling within the level V of fire stability, investors/beneficiaries may adopt a single additional level provided that they are equipped with a fire detection, signalling and alarm system with full coverage, by providing AFDD type devices according to the recommendations of SR EN 62606 and the specifications of the profile standard 'Rule for the design, execution and operation of electrical installations related to buildings', reference number 17 and provided



they comply with measures in brackets specified in Table 2: Minimum conditions for classifying the construction or fire compartment into civil buildings fire stability levels, for fire stability level V.

**Article 3.1.2.8.** (1) Attic conversion of civil buildings (construction of a functional level in the attic volume) is permitted according to the provisions of Table 43.

**Table 43: Attic conversion of civil buildings (realisation of a functional level in attic volume)**

Fire stability level	Reaction to fire class of building elements	Fire resistance of building elements	Separation from the rest of the construction	
			Walls	Doors for communication of the garret floor with the attic
<b>I</b>	<b>A1, A2s1d0</b>	<b>R 90</b>	<b>EI 90</b>	<b>EI<sub>2</sub> 60-C1</b>
<b>II</b>	<b>A1, A2s1d0</b>	<b>R 60</b>	<b>EI 60</b>	<b>EI<sub>2</sub> 45-C1</b>
<b>III</b>	<b>Bs2d0</b>	<b>R 45</b>	<b>EI 45</b>	<b>EI<sub>2</sub>30-C1</b>
<b>IV</b>	<b>Bs3d0</b>	<b>R 30</b>	<b>EI 30</b>	<b>EI<sub>2</sub>15-C1</b>
<b>V</b>	<b>Cs3d0</b>	<b>R 15</b>	<b>EI 15</b>	<b>C1</b>

(2) Attic conversion of civil buildings (the construction of several functional levels in the attic volume) is permitted according to the provisions of Table 44.

**Table 44: Atticing above-ground civil constructions (realization of several functional levels in the volume of the attic)**

Fire stability level	Reaction to fire class of building elements	Fire resistance of building elements	Separation from the rest of the construction	
			Walls	Doors for communication of the garret floor with the attic
investors/beneficiaries may adopt	investors/beneficiaries may adopt	investors/beneficiaries may adopt	investors/beneficiaries may adopt	investors/beneficiaries may adopt
<b>II</b>	<b>A1, A2s1d0</b>	<b>R 90</b>	<b>EI 90</b>	<b>EI<sub>2</sub> 60-C1</b>
<b>III</b>	<b>Bs1d0</b>	<b>R 60</b>	<b>EI 60</b>	<b>EI<sub>2</sub>45-C1</b>
<b>IV</b>	<b>Bs2d0</b>	<b>R 30</b>	<b>EI 30</b>	<b>EI<sub>2</sub>20-C1</b>
<b>V</b>	<b>Bs3d0</b>	<b>R 15</b>	<b>EI 15</b>	<b>EI<sub>2</sub>15-C1</b>

**Article 3.1.2.9.** (1) Attic conversion of civil buildings shall be ensured by the construction of sections of the building with minimum **A1, A2-s1d0** fire-resistant sectorial walls as follows:

- a. **EI/REI 120**, in buildings with fire stability level **I**;
- b. **EI/REI 90** in buildings with fire stability level **II**
- c. **EI/REI 60** in buildings with fire stability level **III**;
- d. **EI/REI 30** in buildings with fire stability level **IV**
- e. **EI/REI 15** in buildings with fire stability level **IV** or **V**.

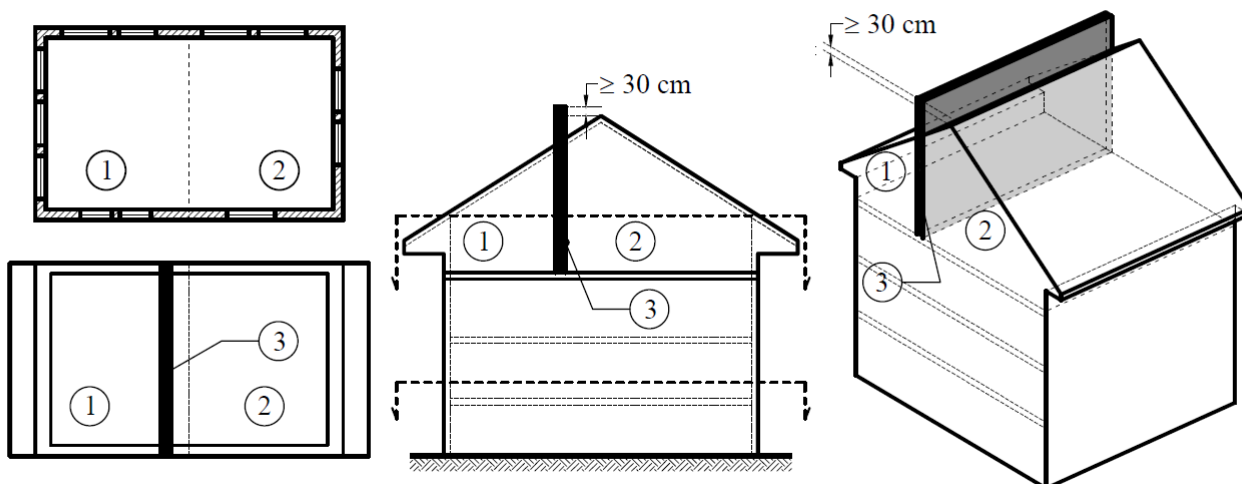
(2) Attic conversion of civil buildings (construction of a functional level in attic volume) is permitted if the fire-resistant sectorial walls exceed by a minimum (Figure 66):

– **30 cm** (measured vertically), from any such combustible element of roofs and skylights with less than four **4 m** insulation wall distance, including sheet support roofs and thermal insulation which are not the reaction to fire class **A1** or **A2-s1d0**;

– **30 cm** (measured vertically), from the outer plane of roofs not made exclusively of substantial components with the reaction to fire class **A1** or **A2-s1d0** it intersects;

– **30 cm** (measured vertically), from the external plane of skylights less than four **4 m** distance from the partition wall;

– **30 cm** (measured horizontally) from external walls and eaves not made exclusively of substantial components with reaction to fire class **A1** or **A2-s1d0**;



**Variant a.1) – Level plan current and attic plan**

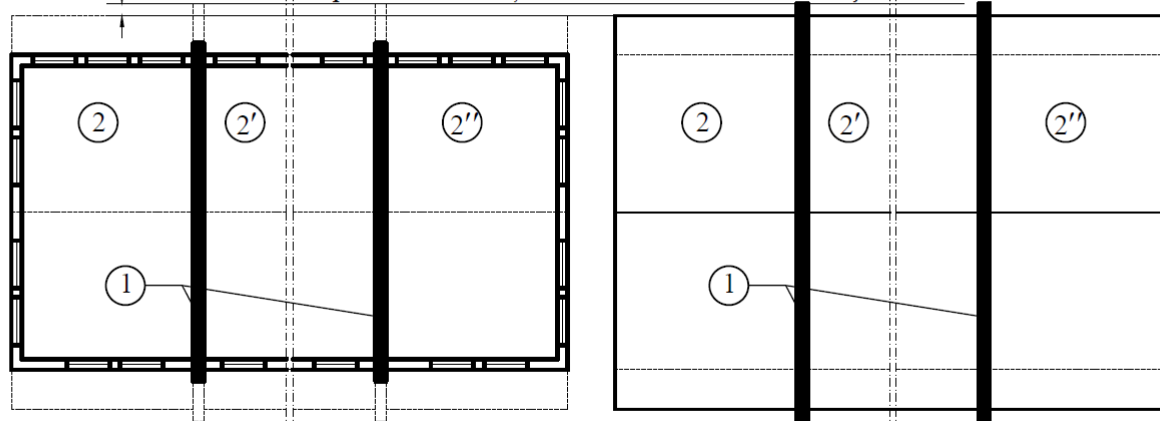
**Variant a.1) – Section**

**Variant a.1) – Perspective geometry**

**Variant a.1) – parallel sectioning to the slope line at the level of the attic – minimum overrun 30 cm (measured vertically), from any combustible element of roofs through fire resistant walls**

**Legend Fig. 67 variant a.1): 1 and 2 – sections with the area according to Article 3.1.2.9 (3); 3 – fire resistant walls according to Article 3.1.2.9 (1) separating the plan of the attic**

**≥ 30 cm (măsurat pe orizontală) față de pereții exteriori și streășinile care nu sunt realizate exclusiv din componente substanțiale care nu sunt clasa de reacție la foc A1 sau A2-s1d0**

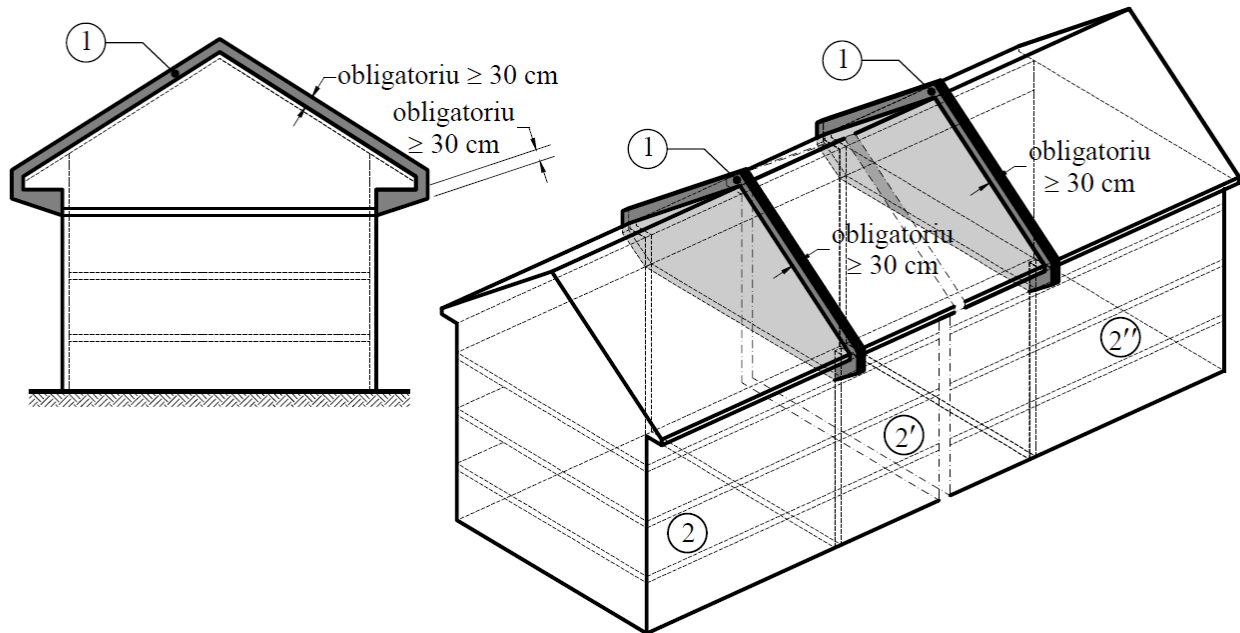


**> 30 cm (măsurat pe orizontală) față de pereții exteriori și streășinile care nu sunt realizate exclusiv din componente substanțiale care nu sunt clasa de reacție la foc A1 sau A2-s1d0**

**> 30 cm (measured horizontally) from external walls and eaves not made exclusively of substantial components which are not the reaction to fire class A1 or A2-s1d0**

**Variant a.2) – Current level plan**

**Variant a.2) – Cover plan**



obligatoriu $\geq$ 30 cm	mandatory $\geq$ 30 cm
--------------------------	------------------------

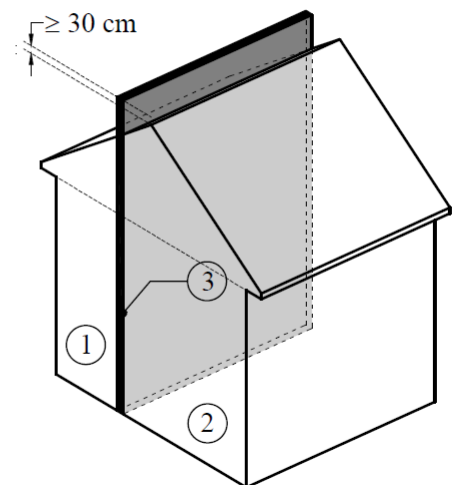
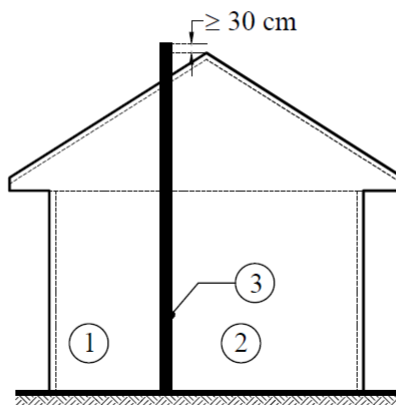
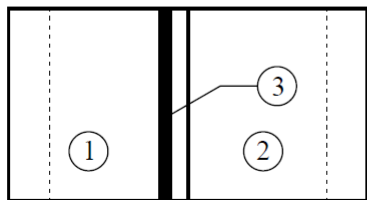
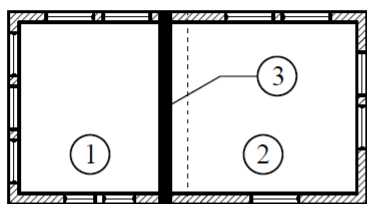
**Variant a.2) – Section**

**Variant a.2) – Perspective geometry**

**Legend Fig. 67 variant a.2):** 1 – fire resistant walls according to **Article 3.1.2.9 (1)** separating the plan of the attic; 2, 2', 2'' - sections with the area according to **Art. 3.1.2.9.(3)**

**Variant a.2) – perpendicular sectioning to the slope line – exceedance with minimum 30 cm** from the outer plane of roofs and eaves not made exclusively of substantial components with the reaction to fire class **A1** or **A2-s1d0** which it intersects through fire resistant walls

**Variant a) – sectioning at the level of the attic – exceedance with a minimum 30 cm** (measured perpendicular to the vertical) of the outer plane of the roofs and minimum 30 cm (measured horizontally) from the outer plane of eaves not made exclusively of substantial components of the reaction to fire class **A1** or **A2-s1d0**, which it intersects through fire resistant walls according to **Article 3.1.2.9 (1)** separating the plan of the attic



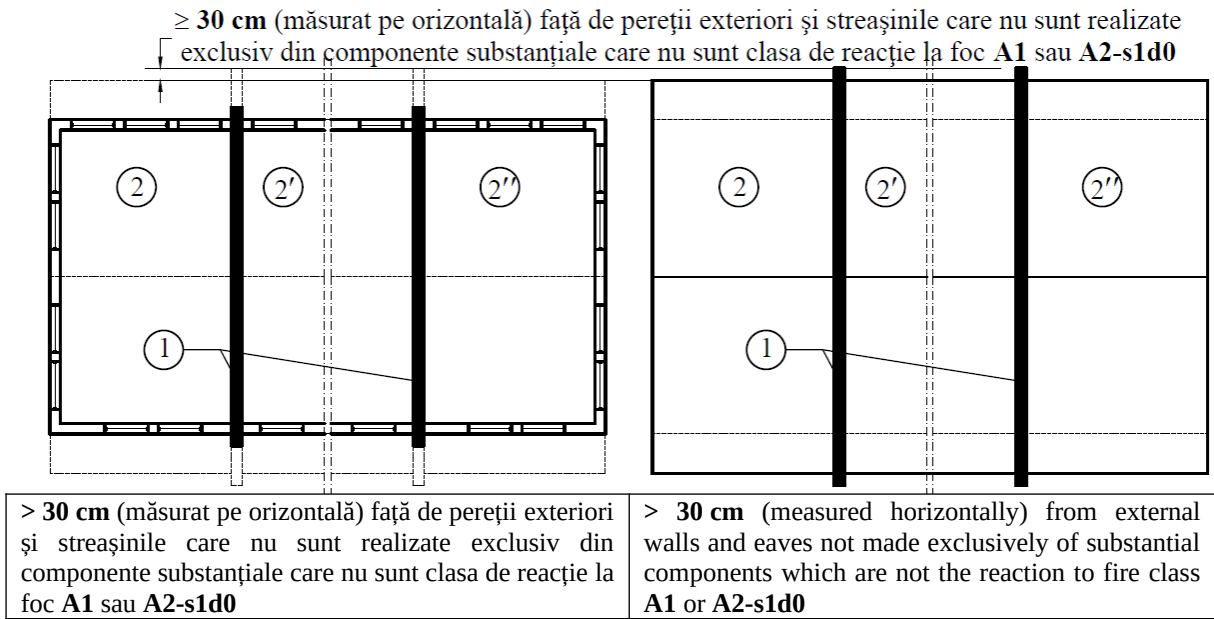
**Variant b.1) – Current level plan**  
(including attic plan) and  
covering plan

**Variant b.1) – Section**

**Variant b.1) – Perspective geometry**

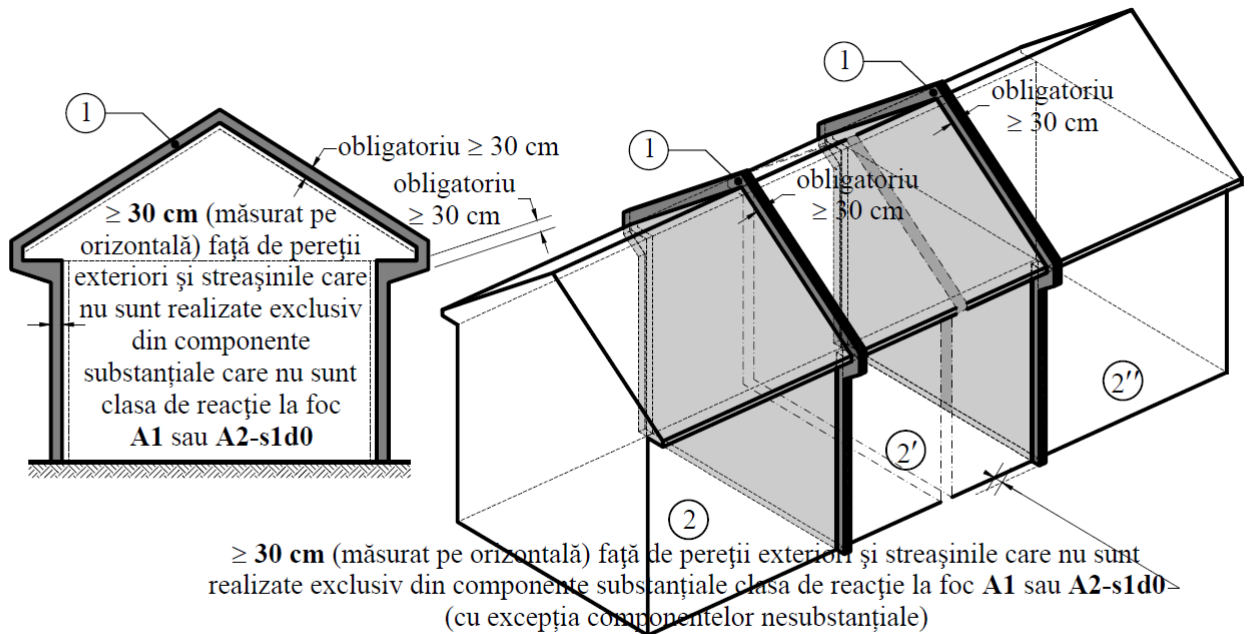
**Variant b.1) – sectioning on the entire height of the construction – exceedance by a minimum 30 cm** (measured perpendicular to the vertical) of the outer plane of the roofs and minimum 30 cm (measured horizontally) from the outer plane of external walls and eaves not made exclusively of substantial components of the reaction to fire class **A1** or **A2-s1d0**, which it intersects through fire resistant walls dividing the whole building

Legend Fig. 67 variant b.1): 1 and 2 – sections with the area according to Article 3.1.2.9 (3); 3 – fire resistant walls according to Article 3.1.2.9 (1) dividing the whole building



Variant b.2) – Current level plan

Variant b.2) – Covering plan



obligatoriu ≥ 30 cm	mandatory ≥ 30 cm
≥ 30 cm (măsurat pe orizontală) față de pereții exteriori și streășinile care nu sunt realizate exclusiv din componente substanțiale care nu sunt clasa de reacție la foc A1 sau A2-s1d0 (cu excepția componentelor nesubstanțiale)	≥ 30 cm (measured horizontally) towards the outer walls and eaves not made exclusively of substantial components which do not fall within the reaction to fire class A1 or A2-s1d0 (excluding not substantial components )

Variant b.2) – Section

Variant b.2) – Perspective geometry

Legend Fig. 67 variant b.2): 1 – fire resistant walls according to Article 3.1.2.9 (1) dividing the whole building; 2, 2', 2'' - sections with the area according to Art. 3.1.2.9.(3)

Variant b.2) – sonar sections perpendicular to the slope line – exceedance with minimum 30 cm from the outer plane of roofs, external walls and eaves not made exclusively of substantial components of the reaction to fire class A1 or A2-s1d0 which it intersects)

**Variant b) – sectioning at the whole height of the construction** – exceedance with minimum **30 cm** (measured perpendicular to the vertical) of the outer plane of the roofs and minimum **30 cm** (measured horizontally) from the outer plane of external walls and eaves not made exclusively of substantial components of the reaction to fire class **A1 or A2-s1d0**, which it intersects through fire resistant walls according to **Article 3.1.2.9 (1)**

**Figure 66 - Separation of building sections (by partition fire walls for civil buildings purposes)**

(3) Minimum fire-resistant partition walls provided for in **paragraph 1** shall be provided at maximum

- a) **65 m** distance, within a maximum area of **1000 m<sup>2</sup>** in civil buildings with fire stability level **I**;
- b) **55 m** distance, within a maximum area of **875 m<sup>2</sup>** in civil buildings with fire stability level **II**;
- c) **45 m** distance, within a maximum area of **625 m<sup>2</sup>** in civil buildings with fire stability level **III**;
- d) **35 m** distance, within a maximum area of **500 m<sup>2</sup>** in civil buildings with fire stability level **IV**;
- e) **25 m** distance, within a maximum area of **300 m<sup>2</sup>** in civil buildings with fire stability level **V**.

(4) Operation of civil buildings with a level of fire stability **I-II** is permitted under the conditions of **paragraph 1** and structural building elements used in the construction of the attic shall have a minimum reaction to fire class **A1, A2 s1, d0**.

(5) In buildings with fire stability **III-V**, attic conversion shall be permitted under the conditions set out in Table 42, with the number of levels of the attic being included in the number of above-ground construction levels and taking into account when determining the level of fire stability of the construction.

### **3.1.3. LIMITING THE SPREAD OF FIRES**

**Article 3.1.3.1.** In civil buildings, it shall be ensured that the rooms are separated from the rest of the building according to the provisions on common and specific performances and, where the standard does not provide, internal partition walls designed to limit the spread of fire according to the provisions of **Article 2.1.3.2** and Table 2.

**Article 3.1.3.2.** Fire safety measures for above-ground civil constructions with normal heights shall be established and ensured according to the level of fire stability provided, destination, fire risks, number of levels, densities of thermal loads (q) and building type, according to the provisions of the Rule.

**Article 3.1.3.3. (1)** In order to limit the propagation of fire within a fire compartment, it shall be provided with partitions intended for the purpose of reducing the spread of fire within a fire compartment. by protection against fire limiting propagation inside the fire compartments that cut across the civil building (may have a sinuous route and may be shifted vertically).

(2) The minimum conditions that must be met by the walls and doors of partition walls with the role of partitioning provided for limiting the spread of fire inside a fire compartment are specified in **Table 45**.

(3) In civil buildings, these partition walls designed to limit the spread of fire within a fire compartment shall be located not more than:

- a) **130 m** distance in civil constructions with fire stability level **I**;
- b) **110 m** distance in civil constructions with fire stability level **II**;
- c) **90 m** distance in civil constructions with fire stability level **III**;

- d) 70 m distance in civil constructions with fire stability level IV;  
e) 50 m distance in civil constructions with fire stability level V.

(4) In residential buildings, separation shall be made between apartments and between them and common horizontal paths, with fire resistant walls according to specific provisions.

(5) In attic buildings, the fragmenting partitions designed to limit the spread of fire inside a fire compartment shall also separate the volume of the attic.

(6) Production/storage buildings shall comply with the specific provisions.

(7) In all cases where sectoral walls are provided in or between open space groupings, according to the classification of the construction/fire compartment to the fire stability level, shall comply as minimum the provisions of Table 45.

**Table 45: Fire behaviour of the walls and doors with sectorization role designed to limit the spread of fire within a fire compartment**

Fire stability level	Permitted reaction to fire levels in walls with a sectorization role by protection against fire limiting propagation inside fire compartments				
	Walls		Sectorization over the length of a civilian building (cross-dividing the civilian building)		Functional separation
			Distance between them (m)	Doors	Doors
I	EI/REI 120	A1 or A2-s1d0	130	EI <sub>2</sub> 60-C5S <sub>200</sub>	EI <sub>2</sub> 60-C5S <sub>200</sub>
II	EI/REI 90	A1 or A2-s1d0	110	EI <sub>2</sub> 60-C5S <sub>200</sub>	EI <sub>2</sub> 45-C5S <sub>200</sub>
III	EI/REI 60	A1 or A2-s1d0	90	E 45-C5S <sub>a</sub>	E 30-C5S <sub>a</sub>
IV	EI/REI 30	B-s1d0	70	E 30-C5S <sub>a</sub>	E 15-C5S <sub>a</sub>
V	EI/REI 15	C-s1d0	50	E 15-C5S <sub>a</sub>	C5

**Article 3.1.3.5.** The minimum requirements to be met by walls, doors and separation floors of staircases, corridors and halls in ordinary height civilian buildings, when they are not in the specific destinations detailed in the Rule, are specified in **Table 46 and Table 47**.

**Table 46: Fire behaviour of walls, doors and separation floors of enclosed staircases in civil buildings of ordinary heights, when not found in the specific destinations detailed in the Rule**

Fire stability level	Permitted reaction to fire levels in closed stairways				
	Walls		Floors (separating the staircases from the rest of the construction)		Doors (excluding apartment doors)
I h ≥ 28m	EI/REI 180	A1 or A2-s1d0	REI 120	A1 or A2-s1d0	E60 - C5 S <sub>200</sub>
II	EI/REI 180	A1 or A2-s1d0	REI 120	A1 or A2-s1d0	E45 - C5 S <sub>200</sub>
II (+)	EI/REI 120	A1 or A2-s1d0	REI 90	A1 or A2-s1d0	E45 - C5 S <sub>200</sub>
III	EI/REI 90	A1 or A2-s1d0	REI 60	A1 or A2-s1d0	E30 - C5 S <sub>a</sub>
III (+)	EI/REI 60	A1 or A2-s1d0	REI 45	A1 or A2-s1d0	E30 - C5 S <sub>a</sub>
IV	EI/REI 45	A1, A2-s1d0 or	REI 30	A1, A2-s1d0 or	C5

Fire stability level	Permitted reaction to fire levels in closed stairways				
	Walls		Floors (separating the staircases from the rest of the construction)		Doors (excluding apartment doors)
		<b>B-s1d0</b>		<b>B-s1d0</b>	
<b>V</b>	<b>EI/REI 30</b>	<b>A1, A2-s1d0, B-s1d0, C-s1d0, D-s1,d0</b>	<b>REI 15</b>	<b>A1, A2-s1d0, B-s1d0, C-s1d0, D-s1,d0</b>	<b>C5</b>

Notes:

(+) Construction works equipped with automatic sprinkler/spray fire-extinguishing systems in addition to the requirements of the specific technical regulations.

'h' = elevation of the last accessible/usable floor of the construction from the reference level

**Table 47: Fire behaviour of walls, doors and floors separating horizontal escape routes (corridors and halls) in civil buildings of ordinary heights, when not found in the specific destinations detailed in the Rule**

Fire stability level	Permitted reaction to fire levels in corridors and halls				
	Walls		Floors (separating corridors and halls from the rest of the construction, including their exit paths to the land level or adjacent roads)		Doors (except those to closed staircases)
<b>I</b> <b>h ≥ 28m</b>	<b>EI/REI 90</b>	<b>A1 or A2-s1d0</b>	<b>In accordance with Table 2, point 3</b>  The minimum fire resistance requirements to be met by the floors (REI) for compliance with the established fire stability level.	<b>A1 or A2-s1d0</b>	<b>E30 - C5 S<sub>200</sub></b>
<b>II</b>	<b>EI/REI 60</b>	<b>A1 or A2-s1d0</b>		<b>A1 or A2-s1d0</b>	<b>E15 - C5 S<sub>a</sub> or full doors of wood or metal</b>
<b>II (+)</b>	<b>EI/REI 60</b>	<b>A1 or A2-s1d0</b>		<b>A1 or A2-s1d0</b>	<b>E15 - C5 S<sub>a</sub> or full doors of wood or metal</b>
<b>III</b>	<b>EI/REI 45</b>	<b>A1 or A2-s1d0</b>		<b>A1 or A2-s1d0</b>	<b>C5</b>
<b>III (+)</b>	<b>EI/REI 45</b>	<b>A1, A2-s1d0, B-s1d0</b>		<b>A1 or A2-s1d0</b>	<b>C5</b>
<b>IV</b>	<b>EI/REI 30</b>	<b>A1, A2-s1d0, B-s1d0</b>		<b>A1, A2-s1d0, B-s1d0</b>	<b>C5</b>
<b>V</b>	<b>EI/REI 15</b>	<b>A1, A2-s1d0, B-s1d0, C-s1d0, D-s1,d0</b>		<b>A1, A2-s1d0, B-s1d0, C-s1d0, D-s1,d0</b>	<b>-</b>

Notes:

a) In the case of glazed metal walls separating corridors and halls from adjacent rooms, the reaction to fire class shall not be taken into account.

'-' = no fire determined performance

(+) Construction works equipped with automatic sprinkler/spray fire-extinguishing systems in addition to the requirements of the specific technical regulations.

**Article 3.1.3.6. (1)** Functions with different fire risks pooled into a civil (public) building shall be separated from the rest of the construction by protected walls, floors and gaps, according to the general provisions, common and specific performances laid down in the Rule.

**(2)** Kitchens and hot cooking areas shall be insulated from publicly accessible spaces, bounded by walls **A1, A2-s1, d0** minimum **EI/REI 60** and floors **A1, A2-s1, d0** minimum **REI 60** and communication doors shall be minimum **E15**. Specific provisions shall be complied with in residential buildings.

(3) Kitchens and hot cooking areas freely arranged in public spaces shall be delineated with screens of minimum **0.50 m**, underneath the ceiling, made of materials **A1, A2-s1, d0** with resistance to fire **DH 30**.

(4) In kitchens located in high, very high buildings or for busy rooms, the hoods shall be provided with automatic extinguishing systems.

(5) Kitchens, with the exception of those arranged in residential buildings, shall be equipped with at least 2 (two) portable fire extinguishers with extinguishing performance at least **75F**.

(6) Regardless of the function of the building, the separation of common horizontal escape paths (which are taken in the calculation of the length of the escape routes) from the adjacent sanitary units (bathrooms, showers, W.C.) may be carried out according to the standard conditions for compliance with the fire stability level. The boundaries of sanitary toilets from other spaces (with the exception of common horizontal escape paths) shall be made through walls with the minimum fire resistance required for horizontal common escape paths (corridors, halls), if spaces adjacent to toilet facilities do not generate higher wall performance. It is not necessary to delimit sanitary facilities to sleeping rooms, hospital salons, offices, etc. by means of fire performance elements. When sanitary toilets start in spaces of common horizontal escape paths provided with excess pressure, the wall-boundary rule set out above may be applied and the doors shall be self-closing (– C).

**Article 3.1.3.7.** Spaces accessible to the public shall be so constructed and protected as to protect them from smoke in the event of fire, in compliance with the specific conditions laid down in the Rule and other specific regulations.

### **3.1.4. Constructive compositions**

**Article 3.1.4.1. (1)** Civil buildings shall be constituted according to the provisions of the Rule, fulfilling their general and specific performance. The use of construction materials class **A1** or **A2-s1d0** is recommended.

(2) Where materials and elements of other classes of reaction to fire may be used according to the provisions of the Rule (excluding the class **A1** or **A2-s1d0**), depending on the specific conditions and fire safety scenarios developed and the role they play in the event of a fire, appropriate protection measures shall be provided according to the Rule.

(3) The construction elements used must not easily propagate fire by means of their composition and construction.

**Article 3.1.4.2.** Vertical (stairways, ramps) and horizontal paths intended for normal functional movement and fire escape for construction users must meet the standard conditions for layout, composition, dimensioning and fire resistance, according to the standardised provisions on common performance and specific to the use and type of buildings.

**Article 3.1.4.3. (1)** Lifts (for functional circulation, freight, transport of disabled persons, fire brigade, small materials, etc.) and, in general, vertical transport systems in civil buildings, including rooms for their machinery, shall be separated from the rest of the building by fire resistant walls (**EI** as appropriate **REI**) and fire resistant floors (**REI**), according to the provisions on the common performance of the Rule.

(2) Gaps on floor levels in which users have access to cargo lifts in civil buildings of normal height shall be protected by:

- a) fire resistant doors minimum **EI 90** for level **I and II** of fire stability;
- b) fire resistant doors minimum **EI 60** for level **III** of fire stability (**EI45** in the case of additional equipment of the construction works with automatic sprinkler extinguishing systems);
- c) fire resistant doors minimum **EI 30** for level **IV** of fire stability;
- d) fire tight doors minimum **E 15**, for level of **V** of fire stability (where lifts are permitted).



(3) Gaps of access to lifts intended for the functional movement (transport) of persons (non-disabled or disabled) in civil constructions of normal height shall be protected according to **Article 2.4.4.2.5 (1)**. In all cases, account shall be taken of the provisions laid down in **Article 2.4.4.2.5 paragraph 2** and **paragraph 3**.

**Article 3.1.4.4. (1)** Lifts for the transport of persons by wheelchairs or disabled persons which may also be used for their assisted escape in the event of fire shall be provided for buildings with persons who cannot evacuate themselves (defined according to terminology) and additionally according to **Article 2.4.4.3.3**.

(2) Lifts provided for the transport of persons by wheelchairs or disabled persons which may also be used for their assisted escape in the event of fire shall be provided in their own well separated from the rest of the construction by minimum fire-resistant walls **EI/REI 90** and, where appropriate, minimum fire resistant floors **REI 60** reaction class to fire **A1** or **A2-s1d0**. Specific provisions shall be respected in high and very high buildings.

(3) Lifts provided for the transport of persons by wheelchairs or disabled persons may also be used for their assisted escape in the event of fire, provided that they comply simultaneously with the following conditions:

- a) have its own well equipped with an overpressure installation separate from the rest of the construction with minimum fire resistant walls **EI/REI 90** and minimum fire-resistant floors **REI60** reaction class to fire **A1** or **A2-s1d0**;
- b) have ensured operation for a minimum **60** minutes after the outbreak of the fire;
- c) have access to common horizontal traffic routes, a hall or a direct outdoor access;
- d) they are tied to a staircase or exit outwards, directly or via a separate access path (corridor, hall);
- e) in front of the landing doors of such lifts, a waiting area shall be provided that does not block the escape movement of other users;
- f) they are powered by two independent sources;
- g) have ensured appropriate marking and signposting.

**Article 3.1.4.5. (1)** Access to lifts provided for the transport of wheelchairs persons or disabled persons which can also be used for their assisted escape in the event of fire at the above-ground levels of civil buildings of normal height shall be provided by:

– fire resistant landing doors **EI 60** when they start in smoke free spaces (protected escape or protected corridors with excess pressure or air inlet and mechanical smoke discharge); in this case the spaces in which the doors of the lifts are opened shall be provided with walls of the reaction class fire reaction class **A1** or **A2-s1d0**, fire resistant minimum **EI/REI 60** and doors minimum **EI<sub>2</sub>30-C5S<sub>200</sub>**;

– construction of buffer rooms ventilated under excess pressure, fitted with fire and smoke tight doors **E30-C5S<sub>200</sub>** towards horizontal common paths and fire resistant doors **EI60** in lifts doors; in this case, the ventilated buffer room in over pressure shall be provided with fire walls in class **A1** or **A2-s1d0**, fire resistant minimum **EI/REI 60**.

(2) Access to lifts provided for the transport of persons by wheelchairs or disabled persons which may also be used for their assisted escape in the event of fire at the underground levels of civil buildings of normal height shall be ensured by the provision of buffer rooms ventilated in over pressure, fitted with fire resistant doors and smoke tight doors **EI<sub>2</sub>60-C5S<sub>200</sub>** towards horizontal common paths and fire resistant doors **EI60** in lifts doors; in this case, the ventilated buffer room in over pressure shall be provided with fire walls in class **A1** or **A2-s1d0**, fire resistant minimum **EI/REI 60**.

(3) If the lifts which can also be used for the assisted escape of persons with wheelchairs or disabled persons shall have a two-access cab, all specified gaps shall meet the conditions of **paragraph 1** and **paragraph 2**.

(4) Lifts provided for the transport of persons by wheelchairs or disabled persons which may also be used for their assisted escape in the event of fire from civil buildings of normal height shall have controls in protected corridors or clearance.

(5) Specific provisions shall be complied with in high, very high and buildings with crowded rooms.

**Article 3.1.4.6. (1)** When the gaps of access to lifts provided for the functional movement of persons and to lifts intended for the transport of persons by wheelchairs or disabled persons which may also be used for their assisted escape in the event of fire at the above-ground levels of buildings of normal height, start in a ventilated buffer room at common overpressure, all doors in lifts shall be minimum **EI60** and fire resistant and smokeproof doors shall be provided in the ventilated buffer room in excess pressure **EI<sub>2</sub>30-C5S<sub>200</sub>** and walls with reaction to fire class **A1** or **A2-s1d0**, fire resistant min. **EI/REI 60**. At underground levels, all doors in lifts shall be minimum **EI60** and fire resistant and smokeproof doors shall be provided in the ventilated buffer room in excess pressure **EI<sub>2</sub>60-C5S<sub>200</sub>** and walls of reaction to fire class **A1** or **A2-s1d0**, fire resistant min. **EI/REI 60**.

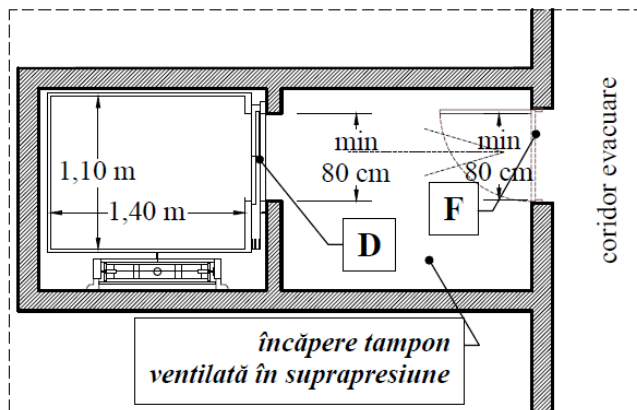
(2) When the access gaps to the lifts provided for the functional movement of persons, to the escape stairways of persons and to the lifts provided for the transport of people by wheelchairs or people with disabilities that can be used and for their assisted evacuation in case of fire at the levels above-ground floors of normal height buildings open into a common pressure ventilated buffer room, all lift doors shall be minimum **EI60**, the stairway door shall be minimum **EI<sub>2</sub>60-C5S<sub>200</sub>** and fire resistant and smokeproof doors shall be provided in the ventilated buffer room in excess pressure **EI<sub>2</sub>30-C5S<sub>200</sub>** and walls with reaction to fire class **A1** or **A2-s1d0**, fire resistant min. **EI/REI 60**. At underground levels all doors in lifts shall be minimum **EI60**, the door at the staircase shall be minimum **EI<sub>2</sub>60-C5S<sub>200</sub>** and fire resistant and smokeproof doors shall be provided in the ventilated buffer room in excess pressure **EI<sub>2</sub>60-C5S<sub>200</sub>** and walls with reaction to fire class **A1** or **A2-s1d0**, fire resistant min. **EI/REI 60**.

**Article 3.1.4.7. (1)** Fire intervention lifts (fire brigade) are mandatory in the situations set out in the Rule and are carried out according to the provisions on specific performance, arranged in their own shafts, separated from the rest of the construction by minimum fire-resistant walls **REI 120** and where applicable, minimum fire resistant floors **REI 120** reaction class to fire **A1** or **A2-s1d0**.

(2) Emergency lifts in the event of fire (fire brigade) may also be provided according to **Article 2.4.4.4.2. .**

**Article 3.1.4.8. (1)** Access to intervention lifts at the above-ground levels of buildings shall be ensured by the construction of buffers ventilated in excess pressure, fitted with fire-resistant and smoke tight doors **EI<sub>2</sub>30-C5S<sub>200</sub>** towards horizontal common paths and fire resistant doors **EI120** in lifts doors and ventilated buffer room under excess pressure shall be provided with walls with reaction to fire class **A1** or **A2-s1d0**, fire resistant min. **EI/REI 120** (according to Figure 67 variant a).

(2) Access to intervention lifts at the underground levels of civil buildings shall be ensured by the development of buffer rooms ventilated in excess pressure, fitted with fire resistant and smoke tight doors **EI<sub>2</sub>60-C5S<sub>200</sub>** towards horizontal common paths and fire resistant doors **EI120** in lifts doors and ventilated buffer room under excess pressure shall be provided with walls with reaction to fire class **A1** or **A2-s1d0**, fire resistant min. **EI/REI 120** (according to Figure 67 variant b).



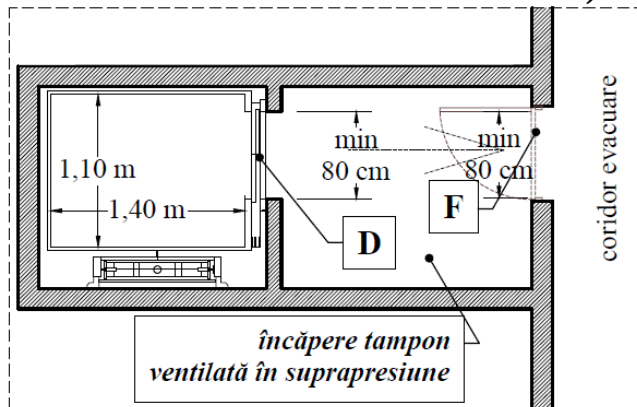
LEGEND:

**D** – doors **EI120**

**F** – doors **EI<sub>2</sub>30-C5S<sub>200</sub>**

Note: the walls of the ventilated buffer room under excess pressure shall be resistant to fire min. **EI/REI 120**

Variant a) above ground



LEGEND:

**D** – doors **EI120**

**F** – doors **EI<sub>2</sub>60 -C5S<sub>200</sub>**

Note: the walls of the ventilated buffer room under excess pressure shall be resistant to fire min. **EI/REI 120**

Variant b) underground

încăpere tampon ventilată în suprapresiune	ventilated buffer room in excess pressure
coridor evacuare	escape corridor

Figure 67 – Access to intervention lifts of buildings (minimum requirements)

(3) If the intervention lifts have a two-access cab, all specified gaps shall meet the conditions of **paragraph 1** and **paragraph 2**.

(4) High or very high buildings shall be provided according to the specific provisions.

(5) The dimensions of the cab of the fire intervention lift (fire brigade) shall be at least **1 100 mm** width and **1 400 mm** depth, with a nominal load of **630 kg**; the minimum width of the free passage of the cab door shall be **800 mm**. If the fire lift is intended to be used for evacuation, to carry stretchers or beds, or is a lift with a two-access cab, which is usually not recommended, then the minimum rated load must be **1 000 kg** and dimensions of the cab of **1 100 mm** width and **2 100 mm** depth.

(6) The intervention lifts shall be automatically brought to the ground floor in the event of fire and shall have a priority call for firefighters.

(7) Panoramic lifts may not be used as fire intervention lifts (fire brigade).

(8) Fire response lifts (fire brigade) are supplied with electricity from two independent sources.

(9) The fire intervention lift shall be positioned within the buildings in such a way that it is provided with access to the outside directly from the outside or through smoke free spaces of the maximum length equivalent to that of the inhabited corridor dimensions of the type or destinations of the construction in which it is situated. The same applies to the provision of several intervention lifts in a construction.

(10) Fire rescue lifts (fire brigade) shall provide firefighters with access to all levels of the building, with the exception of underground parks with more than **4** underground levels embodied in high or very high buildings, where fire lifts (firefighters) for the parking area are separated from fire intervention lifts (fire brigade) at above-ground levels.

(11) In the event of failure or stopping, the rescue lifts in high and very high above-ground buildings and in the buildings where they are still provided, shall be equipped with an access for

stranded firefighters to save themselves or with the help of others (e.g. the escape hatch to be fitted in the cab roof to be fitted with a portable staircase). In the event of a fire, all cabins shall be automatically brought to the ground floor and ramp off until the fire control in the building is cancelled. Exception are emergency lifts and lifts for disabled persons which will operate during the fire by means of emergency supply.

(12) When the gaps of access to lifts provided for the functional movement of persons and to fire response lifts (fire brigade) start in a ventilated buffer room at common pressure, doors from all lifts shall be minimum **EI120** and the ventilated buffer room under excess pressure shall be provided with fire resistant and smoke tight doors **EI<sub>2</sub>30-C5S<sub>200</sub>** above ground and minimum **EI<sub>2</sub>60-C5S<sub>200</sub>** and walls with reaction to fire class **A1** or **A2-s1d0**, fire resistant min. **EI/REI 120**.

(13) When the gaps of access to lifts provided for the functional movement of persons, to the escape staircases for persons and to the lifts provided for fire (fire brigade) start in a ventilated buffer room at common excess pressure, the doors to the lifts shall be at least **EI120** and the door at the staircase shall be minimum **EI<sub>2</sub>120-C5S<sub>200</sub>** and the ventilated buffer room under excess pressure shall be provided with fire resistant and smoke tight doors **EI<sub>2</sub>30-C5S<sub>200</sub>** above ground and minimum **EI<sub>2</sub>60-C5S<sub>200</sub>** and walls with reaction to fire class **A1** or **A2-s1d0**, fire resistant min. **EI/REI 120**.

(14) When gaps of access to the escape staircases of persons, lifts intended for fire response (fire brigade) and other lifts start in a ventilated buffer room under common pressure, doors from all lifts shall be minimum **EI120** and the door at the staircase shall be minimum **EI<sub>2</sub>120-C5S<sub>200</sub>** and the ventilated buffer room under excess pressure shall be provided with fire resistant and smoke tight doors **EI<sub>2</sub>30-C5S<sub>200</sub>** above ground and minimum **EI<sub>2</sub>60-C5S<sub>200</sub>** and walls with reaction to fire class **A1** or **A2-s1d0**, fire resistant min. **EI/REI 120**.

(15) High or very high buildings shall be provided according to the specific provisions.

**Article 3.1.4.9.** Self-supporting or suspended ceilings, raised floor coverings, finishes, thermal and sound-treatment, joinery panels, doors, windows, curtain walls, ventilated facades and double skin facades, roofs, galleries, channels, trestles, installations niches, chimneys, rooms and premises for utility installations related to construction, waste bins rooms, waste compactors and crematoria, storage rooms, billboards located on the facades of buildings, installations and equipment specific to renewable energy, as well as other materials, products or building elements used in civil buildings, shall be carried out according to the provisions on common performance specific to the purpose and type of civil buildings.

**Article 3.1.4.10.** The finishes, on the common functional and exhaust routes of users of buildings of normal height, shall be carried out according to the provisions relating to the common performance of buildings for all purposes.

**Article 3.1.4.11. (1)** The classes of reaction to fire performance of products used for the interior finishing of enclosed staircases and horizontal functional and escape routes (corridors and halls) in above-ground buildings with normal heights shall correspond to the standard provisions specific to the use and type of buildings.

(2) If they are not included in the standard provisions for the specific uses of buildings detailed in the Rule (according to the provisions on performance specific to the use of buildings), the classes of reaction to fire performance of products used for the internal finishing of enclosed staircases and horizontal functional and escape routes (corridors and halls) in above-ground buildings with normal heights shall correspond to the provisions set out in Table 48.

(3) The classes of reaction to fire performance of products used for the interior finishing of enclosed staircases and horizontal functional and escape routes (corridors and halls) in high, very high buildings or buildings with crowded rooms shall also correspond to their specific performance requirements.

**Table 48: Classes of reaction to fire performance of products used for internal finishes in**

**enclosed staircases and of horizontal functional and escape routes (corridors and halls, tunnels, protected openings, etc.) in above-ground buildings of normal heights**

Fire stability level	Finishes					
	in corridors and halls			to closed staircases/protected clearance/tunnels		
	Walls	Ceilings	Floorings	Walls	Ceilings	Floorings
<b>I</b>	<b>A1, A2-s1d0</b>	<b>A1, A2-s1d0</b>	<b>A1<sub>FL</sub>, A2<sub>FL</sub>-s1</b>	<b>A1, A2-s1d0</b>	<b>A1, A2-s1d0</b>	<b>A1<sub>FL</sub>, A2<sub>FL</sub>-s1</b>
<b>II</b>	<b>A1, A2-s1d0</b>	<b>A1, A2-s1d0</b>	<b>A1<sub>FL</sub>, A2<sub>FL</sub>-s1</b>	<b>A1, A2-s1d0</b>	<b>A1, A2-s1d0</b>	<b>A1<sub>FL</sub>, A2<sub>FL</sub>-s1</b>
<b>III</b>	<b>min. B-s1d0</b>	<b>min. B-s1d0</b>	<b>min. B<sub>FL</sub>-s1</b>	<b>min B-s1d0</b>	<b>A1, A2-s1d0</b>	<b>min. B<sub>FL</sub>-s1</b>
<b>IV</b>	<b>min. C-s1d0</b>	<b>min. C-s1d0</b>	<b>min. C<sub>FL</sub>-s1</b>	<b>min. C-s1d0</b>	<b>min. B-s1d0</b>	<b>min. C<sub>FL</sub>-s1</b>
<b>V</b>	<b>min. D-s1d0</b>	<b>min. D-s1d0</b>	<b>min. D<sub>FL</sub>-s1</b>	<b>min. D-s1d0</b>	<b>min. C-s1d0</b>	<b>min. D<sub>FL</sub>-s1</b>

Notes:

- On the common paths of functional circulation and evacuation of users of constructions with normal height, foil finishes with a maximum thickness of 0.5 cm that are glued to A1 or A2-s1d0 support and carpets or wood, with a maximum thickness of 2 cm, are also allowed. ,minimum C<sub>FL</sub>-s1, mounted directly or on a sound-insulating layer for impact noise, which stick or sit freely on A1 or A2-s1d0 support.
- In the case of glazed metal walls separating corridors and halls from adjacent rooms, the reaction to fire class shall not be taken into account.

(4) If they are not included in the provisions laid down for the specific uses of buildings detailed in the Rule (according to the provisions on performance specific to the use of buildings), the classes of reaction to fire performance of products used for the internal finishing of rooms, with the exception of closed staircases and the functional and horizontal escape routes (corridors and halls) in above-ground buildings with normal heights, shall correspond to the provisions of Table 49.

(5) The classes of reaction to fire performance of products used for internal finishing of rooms, with the exception of stairway enclosures and horizontal functional and escape routes (corridors and halls) in high, very high buildings or buildings with crowded rooms, shall also comply with their specific performance requirements.

**Tabelul 49: Classes of reaction to fire performance of products used in indoor finishes in rooms, excluding closed stairways and horizontal functional and escape routes (corridors and halls, tunnels, protected openings, etc.) in above-ground buildings of normal heights**

Fire stability level	Finishes in rooms		
	Walls	Ceilings	Floorings
<b>I</b>	<b>min. B-s1d0</b>	<b>min. B-s1d0</b>	<b>min. B<sub>FL</sub>-s1</b>
<b>II</b>	<b>min. B-s2d0</b>	<b>min. B-s2d0</b>	<b>min. C<sub>FL</sub>-s1</b>
<b>III</b>	<b>min. B-s3d0</b>	<b>min. B-s3d0</b>	<b>min. C<sub>FL</sub>-s1</b>
<b>IV</b>	<b>min. C-s3d0</b>	<b>min. C-s3d0</b>	<b>min. D<sub>FL</sub>-s1</b>
<b>V</b>	-	<b>min d0</b>	-

Note: '-' represents 'without required fire performance'

**Article 3.1.4.12. (1)** Storage rooms for combustible materials and substances and those permitted for combustible liquids shall meet the conditions laid down in sub-chapter 2.4.16. **Storage rooms** on storage rooms in civilian buildings.

(2) The storage of goods and substances with a risk of explosion in civil buildings, as well as the location of workshops where such materials are used, is only allowed in the cases mentioned and in compliance with the provisions of the Rule.

### 3.1.5. Escape routes for users in case of fire

**Article 3.1.5.1. (1)** Civil buildings shall have the necessary number of escape routes for users in the event of fire, suitably arranged, constructed and dimensioned, according to the provisions of the Rule (according to the general provisions and on common and specific performance).

**(2)** The walls and separation floors of staircases enclosures and common horizontal functional and escape paths in civil buildings and the functional and escape voids of users, in walls separating from the rest of civil construction stairways, their adjacent land or road exits, and common horizontal functional and escape paths in civil buildings, shall comply with the provisions on the performance specific to the use and type of such buildings.

**(2)** In civil buildings, the gap of access to staircases shall comply with the provisions on performance specific to the purpose and type of civil buildings.

**(3)** In civilian buildings that are not high or very high, health or education, stairway gaps may have self-closing doors **C5**, towards corridors, floor vestibules and halls, unless otherwise provided for in the Rule and the following conditions shall be met:

**a)** the walls and floors of corridors, changing rooms and halls shall have the same fire resistance as staircases;

**b)** doors shall be provided between corridors, changing rooms or halls and adjacent rooms, including other staircases **C5**, and such doors of adjacent rooms shall have fire performance at least equal to that of doors used in closed staircases, corresponding to the performance provisions specific to each destination and type of building;

**c)** any windows for indirect illumination of floor corridors or halls or entrance halls present in walls separating them from adjacent rooms shall be protected according to **Article 2.5.6.2.2**.

**Article 3.1.5.2. (1)** Internal escape staircases open in civil buildings are permitted if they serve to evacuate users not more than two successive above-ground levels.

**(2)** Stairways in the volume of the atrium and not enclosed in own staircases do not constitute escape routes in the event of fire. Exception are the atriums with a maximum height of four construction levels, where it is considered that on the open scale in the atrium, it is possible to ensure the passage of a single escape flow, even if the width of the ramps provides several flows.

**Article 3.1.5.3.** Arrangement, composition, gauges and number of escape routes, escape length, intended routes and number of escape passage (flows) units provided, expected number of users per unit of escape passage (flow) (**U<sub>f</sub>**), must meet the conditions for the movement and escape of construction users laid down in the general provisions, as well as the common performance and the performance specific to the use and type of civil buildings, so as to meet the performance appropriate to the intended purpose, the type of construction, the fire risk and the level of fire stability provided.

**Article 3.1.5.4. (1)** The maximum permissible lengths of escape routes from ordinary height civil buildings (excluding high and very high buildings) shall be those laid down in the provisions on performance specific to the purpose and type of civil buildings, and for atriums as set out in Table 50.

**(2)** The maximum permissible lengths of escape routes from high and very high civil buildings on common horizontal paths open to atriums shall be reduced by **25 %** in relation to the escape lengths specific to these buildings. For sleeping rooms in hotels, motels, homes, hospitals, dwellings and the like in high and very high civil buildings, the length of escape routes on common horizontal paths open to atriums shall be reduced by **50 %**.

**Table 50: Escape lengths on common horizontal paths open to atriums**

		<i>Fire stability</i>	<i>Maximum escape length</i>	
--	--	-----------------------	------------------------------	--

Reference No	Civil buildings	level provided	in two different directions	in a direction (dead-end corridor)	Remarks
			metres	metres	
1.	Common paths open to atrium	<b>I and II</b>	<b>35</b>	<b>20</b>	For sleeping rooms in hotels, motels, homes, hospitals, dwellings and the like, the length of escape routes on common horizontal paths open to atriums shall be reduced by 50 %.
		<b>III</b>	<b>25</b>	<b>15</b>	
		<b>IV</b>	<b>16</b>	<b>12</b>	
		<b>V</b>	<b>10</b>	<b>10</b>	

**Article 3.1.5.5. (1)** Horizontal common paths open to the atrium (platforms, intermediate levels, etc.) may constitute escape routes for persons in adjacent rooms when the escape length does not exceed the maximum permissible values in **Article 3.1.5.4.** and Table 50, from their door to an escape staircase (measured in the path centre), depending on the fire stability level of the construction.

**(2)** Doors in rooms which start in common horizontal paths open to the atrium shall be formed and equipped according to the provisions of the Rule on communication between spaces with different destinations and escape routes.

**Article 3.1.5.6.** Expected number of users per escape passage (flow) unit (**Uf**) of ordinary civil constructions are given in Table 51.

**Table 51: Standardised number of users per escape passage (flow) unit (Uf) from civil constructions with normal heights**

Reference No	Destination of the construction or part of the construction from which users are evacuated	Standardised number of users per escape passage (flow) unit ( <b>Uf</b> )
1	Intended for persons who cannot evacuate themselves (defined according to terminology), etc.	<b>50</b>
2	For education of all grades (except those listed under reference No 1), culture, worship, administration, social, laboratories, cinematographic and radio studios, assembly rooms, auditors, commerce, exhibitions, catering, reading, sport, waiting, car parks, etc.	<b>70</b>
3	Accommodation, hotels, hostels, alpine lodges, boarding houses, etc.	<b>80</b>

Note:

Expected number of users per escape passage (flow) unit (**Uf**) in high, very high buildings or buildings with crowded rooms and independent underground civil buildings are specified in their specific performance provisions.

### **3.1.6. Conditions for access, intervention and rescue in the event of fire**

**Article 3.1.6.1. (1)** Above-ground civil constructions with normal heights shall be provided with conditions for access to and intervention of extinguishing vehicles in the event of fire, according to the provisions of the Rule.

**(2)** Access, intervention and rescue routes shall be suitably sized and marked so that they can be used by personnel intervening in the event of fire.

(3) External routes of intervention shall allow easy access to fire-fighter intervention vehicles and shall be marked and kept free at all times. As a rule, the intervention to at least at one facade of the building shall be ensured, except in the cases specified in the Rule.

(4) Within civil buildings, suitably marked firefighter routes will allow easy access to the main functional escape paths (horizontal and vertical), as well as to spaces at risk or fire hazard.

(5) In the case of civil structures of normal heights, access and intervention of fire extinguishing vehicles shall be ensured, at least for the percentage (%) within the perimeter of the external walls indicated at each function.

### **3.1.7. EQUIPPING BUILDINGS WITH FIRE-FIGHTING EQUIPMENT AND OTHER MEANS**

**Article 3.1.7.1.** Civil buildings shall be fitted with extinguishers, providing a portable extinguisher with minimum extinguishing performance **21A** and **113B** for a built-up area of up to **250 m<sup>2</sup>** but at least two extinguishers on each level of the building.

**Article 3.1.7.2. (1)** Civil constructions shall be equipped with technical means of fire defence, according to the provisions of the Rule and relevant technical regulations.

(2) In cases where parking spaces for more than **10** cars or other destinations with high or very high fire risks are provided in the basement (basements) of civil constructions with normal heights, they shall be made up, compartmentalized and equipped with signalling and extinguishing installations, according to the specialized technical regulations.

(3) In buildings with atrium, atrium and spaces adjacent thereto which are intended for shops, exhibitions with combustible exhibits and, in general, for functions with high fire risks, it is mandatory to equip fire detection, signalling and alarm systems and automatic fire extinguishing systems according to the Rule **P118/2**, standard **SR EN 12845** and Rule **P118/3**.

## **SECTION II**

### **3.2. Specific performance**

#### **3.2.1. Above-ground dwelling buildings**

**Article 3.2.1.1.** Above-ground residential buildings with ordinary heights, individual (family) or collective (apartment blocks, family and non-family homes, dwelling houses destined to children without shelter), arranged independently or pooled within the boundaries of the areas of the normal fire compartments for civil buildings, shall be placed at safe distances or partitioned from neighbouring buildings according to the provisions of the Rule.

**Article 3.2.1.2.** Above-ground dwelling buildings with ordinary heights, individual or collective, shall be made of products and building elements that ensure that the standard conditions for compliance are met and the correlation between the destination, the level of fire stability ensured, the number of building levels and the area of the fire compartment.

**Article 3.2.1.3.** The materials, products and/or building elements used in above-ground living buildings shall be made out according to the general provisions as well as the provisions on common performances and those specific to the purpose and type of civil buildings.

**Article 3.2.1.4. (1)** The classes of reaction to fire performance of products used for the interior finishing of enclosed staircases and of operating and horizontal escape routes (corridors and halls) in above-ground dwelling buildings of normal heights shall comply with the provisions of Table 52.



(2) The classes of reaction to fire performance of products used for the interior finishing of enclosed staircases and horizontal functional and escape routes (corridors and halls) in high, very high buildings or buildings with crowded rooms shall also correspond to their specific performance requirements.

**Table 52: Classes of reaction to fire performance of products used for internal finishes of functional and escape paths in above-ground dwelling buildings of normal heights**

Fire stability level	Finishes					
	in corridors and halls			to enclosed staircases/protected clearance/escape tunnels		
	Walls	Ceilings	Floorings	Walls	Ceilings	Floorings
<b>I</b>	<b>A1, A2-s1d0</b>	<b>A1, A2-s1d0</b>	<b>A1<sub>FL</sub>, A2<sub>FL</sub>-s1</b>	<b>A1, A2-s1d0</b>	<b>A1, A2-s1d0</b>	<b>A1<sub>FL</sub>, A2<sub>FL</sub>-s1</b>
<b>II</b>	<b>A1, A2-s1d0</b>	<b>A1, A2-s1d0</b>	<b>A1<sub>FL</sub>, A2<sub>FL</sub>-s1</b>	<b>A1, A2-s1d0</b>	<b>A1, A2-s1d0</b>	<b>A1<sub>FL</sub>, A2<sub>FL</sub>-s1</b>
<b>III</b>	<b>min. B-s1d0</b>	<b>min. B-s1d0</b>	<b>min. B<sub>FL</sub>-s1</b>	<b>min. B-s1d0</b>	<b>min. B-s1d0</b>	<b>min. B<sub>FL</sub>-s1</b>
<b>IV</b>	<b>min. C-s1d0</b>	<b>min. C-s1d0</b>	<b>min. C<sub>FL</sub>-s1</b>	<b>min. C-s1d0</b>	<b>min. C-s1d0</b>	<b>min. C<sub>FL</sub>-s1</b>
<b>V</b>	<b>min. D-s1d0</b>	<b>min. D-s1d0</b>	<b>min. D<sub>FL</sub>-s1</b>	<b>min. D-s1d0</b>	<b>min. D-s1d0</b>	<b>min. D<sub>FL</sub>-s1</b>

Note:

(1) On the common paths of functional circulation and evacuation of users of constructions with normal height, foil finishes with a maximum thickness of 0.5 cm that are glued to A1 or A2-s1d0 support and carpets or wood, with a thickness of maximum 2 cm, minimum C<sub>FL</sub>-s1, mounted directly or on a soundproofing layer for impact noise, which are glued or placed freely on A1 or A2-s1d0 support.

(2) The noise insulation layer at impact/vibration damping shall not have fire performance.

**Article 3.2.1.5.** Domestic lodges may be made in the basement or semibasement of above-ground housing buildings, provided that the density of the thermal load does not exceed 840 MJ/m<sup>2</sup>.

**Article 3.2.1.6.** The partitions in residential buildings shall comply with the provisions of Table 53.

**Table 53: Conditions for partitions in above-ground dwelling buildings of ordinary heights**

Reference No	Element name	Level of fire stability	Minimum wall conditions	Remarks
1.	Partitions between sections of the building between apartments and between apartments and common spaces	<b>I</b>	<b>A1, A2-s1d0, EI/REI 90</b>	In sections of the building and semibasement apartments, separation shall be made between apartments, with minimum fire resistant walls <b>A1, A2-s1d0, EI/REI 60</b> (with the exception of the installation of the building in level <b>I</b> of stability where it is necessary for the walls to be provided with minimum <b>EI/REI 90</b> )
		<b>II</b>	<b>A1, A2-s1d0, EI/REI 60</b>	
		<b>III</b>	<b>A1, A2-s1d0, EI/REI 60</b>	
		<b>IV</b>	<b>B-s1d0, EI/REI 45/</b>	
		<b>V</b>	<b>D-s1d0, EI/REI 30</b>	
2.	Partitions between baths and kitchens in relation to the other apartment rooms.	<b>I</b>	<b>EI/REI 45*</b>	* - Or the fire resistant partition from kitchens shall be provided in the day room, provided that the kitchen is freely arranged in
		<b>II</b>	<b>EI/REI 30*</b>	

Reference No	Element name	Level of fire stability	Minimum wall conditions	Remarks
		III	EI/REI 15*	the dayroom.
		IV	-	-
		V	-	-
3.	Partitions between household or storage lodges in basement or semibasement, within groups not exceeding 'x'm <sup>2</sup> .	I II III IV V	A1 or A2-s1d0	No fire resistance conditions, including doors.
4.	Partitions between the household lodge groups referred to in point 3 (with a maximum area of 'x'm <sup>2</sup> ) and between them and the technical premises of the building (with the exception of those which are not expressly explained in the Rule, specific regulations and annexes).	I II III IV V	EI/REI 60	Doors to common corridors of the building shall be at least fire-resistant EI <sub>2</sub> 30-C2 Sa

Notes: "-"= no fire determined performance

'x' =Groupings of domestic lodges or basement or semibasement storage shall be permitted within the following built-up areas:

– maximum **600 sqm**, provided that the built-up area of the rooms of the groups of open space domestic lodges does not exceed 75 % of that of the built-up area of that level for constructions falling within the level **I** of fire safety;

– maximum **400 sqm**, provided that the built-up area of the groups of open space domestic lodges does not exceed 75 % of that of the built-up area of that level for constructions falling within the level **II** of fire safety;

– maximum **300 sqm**, provided that the built-up area of the groups of open space domestic lodges does not exceed 75 % of that of the built-up area of that level for constructions falling within the level **III** of fire safety;

– maximum **200 sqm**, provided that the built-up area of the groups of open space domestic lodges does not exceed 75 % of that of the built-up area of that level for constructions falling within the level **IV** of fire safety;

– maximum **100 sqm**, provided that the built-up area of the groups of open space domestic lodges does not exceed 75 % of that of the built-up area of that level for constructions falling within the level **V** of fire safety equipment;

\* – or the fire resistant partition from kitchens shall be provided in the day room so as to create a gap of **50 cm** below the ceiling to the door case

**Article 3.2.1.7. (1)** In buildings made of combustible materials (under the conditions permitted by the Rule), rooms with a medium fire risk (kitchens, thermal power stations and other spaces where open fire is used) shall have finishes of materials of the reaction to fire class **A1** or **A2-s1d0**.

**(2)** Garages (used exclusively for parking) and car parks not exceeding **3** cars, allotted or embedded in individual (family) residential buildings, shall be separated from the rest of the construction by minimum fire resistant walls **EI/REI 60** and minimum floors **REI 60**. Functional communication gaps in separation walls shall be protected by doors **EI<sub>2</sub> 30-C3**.

**Article 3.2.1.8.** The reaction to fire of walls, doors and separation floors of enclosed staircases and doors in regular dwelling buildings shall comply with the provisions of Table 54.

**Table 54: The reaction to fire of walls, doors and floors from the separation of staircases and doors in residential buildings of normal heights**

Fire stability level	Permitted reaction to fire levels in closed stairways				
	Walls		Floors (separating the staircases from the rest of the construction)		Doors (excluding apartment doors)
<b>I</b> <i>h</i> ≥ 28m	<b>EI/REI 180</b>	<b>A1 or A2-s1d0</b>	<b>REI 120</b>	<b>A1 or A2-s1d0</b>	<b>E 15 - C5 S<sub>200</sub></b>
<b>II</b>	<b>EI/REI 180</b>	<b>A1 or A2-s1d0</b>	<b>REI 120</b>	<b>A1 or A2-s1d0</b>	<b>E 15 - C5 S<sub>200</sub></b>
<b>II (+)</b>	<b>EI/REI 120</b>	<b>A1 or A2-s1d0</b>	<b>REI 90</b>	<b>A1 or A2-s1d0</b>	<b>E 15 - C5 S<sub>200</sub></b>
<b>III</b>	<b>EI/REI 90</b>	<b>A1 or A2-s1d0</b>	<b>REI 60</b>	<b>A1 or A2-s1d0</b>	<b>E 15 - C5 Sa</b>
<b>III (+)</b>	<b>EI/REI 60</b>	<b>A1 or A2-s1d0</b>	<b>REI 45</b>	<b>A1 or A2-s1d0</b>	<b>E 15 - C5 Sa</b>
<b>IV</b>	<b>EI/REI 45</b>	<b>A1, A2-s1d0 or B-s1d0</b>	<b>REI 30</b>	<b>A1, A2-s1d0 or B-s1d0</b>	-
<b>V</b>	<b>EI/REI 15</b>	<b>A1, A2-s1d0, B-s1d0, C-s1d0, D-s1,d0</b>	<b>REI 15</b>	<b>A1, A2-s1d0, B-s1d0, C-s1d0, D-s1,d0</b>	-

Notes:

‘-’ = no fire determined performance

(+) Construction works equipped with automatic sprinkler/spray fire-extinguishing systems in addition to the requirements of the specific technical regulations.

‘h’= elevation of the last accessible/usable floor of the construction from the reference level

**Article 3.2.1.9.** The reaction to fire of walls, doors and separation floors of horizontal escape routes (corridors and halls) and doors in residential buildings of normal heights shall comply with the provisions of Table 55.

**Table 55: The reaction to fire of walls, doors and floors separating the horizontal escape routes (corridors and halls) in residential buildings of normal heights**

Fire stability level	Permitted reaction to fire levels in corridors and halls				
	Walls		Floors (separating corridors and halls from the rest of the construction, including their exit paths to the land level or adjacent roads)		Doors (except those to closed staircases)
<b>I</b> <i>h</i> ≥ 28m	<b>EI/REI 90</b>	<b>A1 or A2-s1d0</b>	<b>According to Table 2, point 3</b>  The minimum fire resistance requirements to be met by the floors (REI) for compliance with the established fire stability level.	<b>A1 or A2-s1d0</b>	-
<b>II</b>	<b>EI/REI 60</b>	<b>A1 or A2-s1d0</b>		<b>A1 or A2-s1d0</b>	-
<b>II (+)</b>	<b>EI/REI 60</b>	<b>A1 or A2-s1d0</b>		<b>A1 or A2-s1d0</b>	-
<b>III</b>	<b>EI/REI 45</b>	<b>A1 or A2-s1d0</b>		<b>A1 or A2-s1d0</b>	-
<b>III (+)</b>	<b>EI/REI 45</b>	<b>A1, A2-s1d0, B-s1d0</b>		<b>A1 or A2-s1d0, B-s1d0</b>	-
<b>IV</b>	<b>EI/REI 30</b>	<b>A1, A2-s1d0, B-s1d0</b>		<b>A1, A2-s1d0, B-s1d0</b>	-
<b>V</b>	<b>EI/REI 15</b>	<b>A1, A2-s1d0, B-s1d0, B-s2d0, C-</b>		<b>A1, A2-s1d0, B-s1d0, B-s2d0, C-</b>	-

Fire stability level	Permitted reaction to fire levels in corridors and halls			
	Walls		Floors (separating corridors and halls from the rest of the construction, including their exit paths to the land level or adjacent roads)	Doors (except those to closed staircases)
		s1d0, C-s2d0, D-s1d0 or D-s2d0		s1d0 or C-s2d0, D-s1d0 or D-s2d0

Notes:

‘-’ = no fire determined performance

(+) Construction works equipped with automatic sprinkler/spray fire-extinguishing systems in addition to the requirements of the specific technical regulations.

‘h’ = elevation of the last accessible/usable floor of the construction from the reference level

**Article 3.2.1.10.** Multi-dwelling buildings (residential buildings), which fall under the category of high or very high above ground buildings, shall comply with the specific performance provisions for these types of buildings.

**Article 3.2.1.11. (1)** The escape staircases of the users of the floor and, where appropriate, of the attic of individual (family) residential buildings, as well as stairways in duplex or triplex apartments in any type of above-ground housing building, may be made of materials of the reaction to fire class **C** or **D** and not enclosed in staircases.

**(2)** The escape staircases for users of the above-ground levels may be continued in the basement of ordinary residential buildings, if the gaps of access to the basement rooms are protected according to the fire risks of those rooms, with fire resistant doors and smoke tight to a minimum **EI<sub>2</sub> 15-C5 S<sub>a</sub>**.

**(3)** Ground level escape doors of above-ground accommodation buildings of normal heights may be with opening inwards. Ground level escape doors of family and unfamiliar above-ground homes of normal heights shall be opened outwards if they evacuate more than **30** persons.

**(4)** Access doors from escape staircases to apartments in above-ground residential buildings of normal heights are recommended to be **E 15**. In high and very high collective residential buildings, the doors for separating residential apartments from the common functional and horizontal escape routes (corridors and halls) of users shall comply with the standardised provisions (**Article 4.1.5.3.** and Table 92 for high buildings and **Article 4.2.5.3.** and Table 96 for very high buildings).

**Article 3.2.1.12.** The maximum permissible escape length of the journey through the escape routes in dwelling buildings (with the exception of high and very high buildings) is specified in **Table 56**.

**Table 56: Escape lengths in above-ground dwelling buildings of normal heights**

Refer ence No	RESIDENTIAL BUILDINGS	Fire stability level provided	Maximum escape length		Remarks
			in two different directions	in a direction (dead-end corridor)	
			metres	metres	
1.	With apartments with one or more rooms	<b>I and II</b>	50	25	Within residential apartments, the length of escape routes shall not be standardised
		<b>III and IV</b>	25	12	
		<b>V</b>	12	8	

Note:

In residential buildings which are not crowded rooms, high buildings or very high buildings and fire compartments fitted with fire detection, signalling and alarm systems with total coverage and equipped with

*automatic fire extinguishing and smoke exhaust systems in horizontal common paths (corridors/halls) and staircases, the standardised escape lengths of users may increase by 25 %.*

**Article 3.2.1.13. (1)** Housing buildings representing individual units (single family, service, intervention, need for support, protocol, holiday homes) or a condominium consisting of individual dwellings and constructions for another, individual, isolated, strung or coupled, in which the individual properties are interdependent by a forced and perpetual joint ownership, with a height  $h =$  maximum **8 m** (where 'h' is the elevation of the last accessible floor of the construction compared to the reference level), access and intervention of the extinguishing vehicles in the event of fire shall be ensured, at least on one side and at least on **15 %** of the perimeter of the external walls.

**(2)** Above-ground multi-dwelling buildings with ordinary heights **h** (where  $> 8 \text{ m}$  'h' is the elevation of the last accessible floor of the construction compared to the reference level), access and intervention of the extinguishing vehicles in the event of fire shall be ensured, at least on one side and at least on **25 %** from the perimeter of the external walls.

**(3)** With the consent of the local authorities (emergency services) and if the urban design allows, access routes adjacent to entrance access to communal housing buildings with maximum **4** normal heights above-ground levels may be used.

**(4)** In accordance with the maximum capacity of the collective housing building at the same time, account must also be taken of the provisions of **Article 2.6.7.** paragraphs **1** and **3.**

### **3.2.2. Above-ground administrative buildings**

**Article 3.2.2.1. (1)** Above-ground civil administrative buildings of ordinary heights (central or local authority and institution buildings, financial-banking, trade unions, partitions, offices, etc.) shall ensure the level of fire stability determined according to the provisions of **Article 2.1.3.2** and Table 2.

**Article 3.2.2.2. (1)** Above-ground administrative buildings of ordinary heights (central or local authority and institution buildings, financial-banking, trade unions, partitions, offices, etc.) shall be constituted according to the destination in such a way as to ensure the fulfilment of the specific fire safety performance and the conditions for compliance and standardised correlation between the destination, the level of fire stability provided, the area of the fire compartment and the number of above-ground levels according to the provisions of **Article 3.1.2.6.**, **Article 3.1.2.7.** and Table 41 and Table 42.

**(2)** In the case of the incorporation of administrative spaces or rooms into ordinary above ground civil buildings with another destination (housing, education, tourism, commerce, etc.), the provisions specific to mixed-function buildings shall also apply, subject to the strictest conditions.

**(3)** In all cases, the above-ground levels of administrative buildings of normal heights are separated from underground levels with high fire risks (car parks, warehouses, archives, etc.), through floors with minimum fire resistance **REI 120** (including their supporting elements).

**(4)** Administrative buildings falling under the category of crowded rooms or high/very high buildings shall comply with the specific conditions of these types of buildings. The underground administrative constructions shall comply with the specific regulatory requirements. Administrative rooms arranged in the basement of above-ground buildings or high/very high buildings shall also comply with their specific conditions

**Article 3.2.2.3.** The minimum fire safety distances to be ensured between above-ground civil administrative buildings of ordinary heights (central or local authority and institution buildings, financial-banking, trade unions, partitions, offices, etc.) and other buildings are established according to the provisions of **Article 2.2.1.2** and Table 4.

**Article 3.2.2.4. (1)** In above-ground administrative civil buildings structures of normal heights, the rooms shall be separated from the rest of the building according to the provisions on common and specific performances and, where the standard does not provide, internal partition walls designed to limit the propagation of fire according to the provisions laid down in **Article 2.1.3.2.** and Table 2.

**(2)** Within groupings of open space office rooms, a minimum of sector-specific partitions shall be provided to limit the propagation of fire to adjacent spaces (excluding those to escape routes complying with the specific provisions and those to rooms with a higher risk arising from the density of heat load in adjacent rooms), which shall be the reaction to fire class **A1, A2-s1, d0** minimum:

**a)** **EI/REI 120** , fitted with fire resistant and smoke tight doors **EI<sub>2</sub> 60-C5S<sub>200</sub>** in above-ground civil administrative constructions with normal heights having fire stability level **I**;

**b)** **EI/REI 90** fitted with fire resistant and smoke tight doors **EI<sub>2</sub> 45-C5S<sub>200</sub>** in above-ground civil administrative constructions with normal heights having fire stability level **II**;

**c)** **EI/REI 60** fitted with fire tight and smoke tight doors **E 30-C5S<sub>a</sub>** in above-ground civil administrative constructions with normal heights having fire stability level **III**;

**d)** **EI/REI 30** fitted with fire tight and smoke tight doors **E 15-C5S<sub>a</sub>** in above-ground civil administrative constructions with normal heights having fire stability level **III**;

**e)** **EI/REI 15** fitted with doors **C5** in above-ground civil administrative constructions with normal heights having fire stability level **V**.

**(3)** Groupings of office rooms with the same fire risk and the same destination (self-contained or complementary as described in the Annex) divided into each other by opaque or glazed panels, fixed or movable, used as functional separation and/or sound insulation or functional partitions, shall be permitted within the following areas built within normal administrative structures:

– maximum **1 000 m<sup>2</sup>**, provided that the built-in area of the open space does not exceed **75 %** of that of the built-up area of that level for administrative constructions falling within the level **I** of fire stability;

– maximum **600 m<sup>2</sup>**, provided that the built-up area of the open space office rooms does not exceed **75 %** of that of the built-up area of that level for administrative constructions falling within the level **II** of fire stability;

– maximum **300 m<sup>2</sup>**, provided that the built-up area of the open space office rooms does not exceed **50%** of that of the built-up area of that level for administrative constructions falling within the level **III** of fire stability;

– maximum **150 m<sup>2</sup>**, provided that the built-up area of the open space office rooms does not exceed **25%** of that of the built-up area of that level for administrative constructions falling within the level **IV** of fire stability;

– maximum **75 m<sup>2</sup>** provided that the built-up area of the open space office rooms does not exceed **25 %** from that of the built-up area of that level for administrative constructions falling within the level of **V** of fire stability;

**(4)** To administrative constructions of normal heights equipped with fire detection, signalling and alarm systems with total coverage, as well as smoke exhaust systems or installations from common horizontal paths (corridors/halls) and staircases, it is permissible to increase the built-up areas of open space office groupings provided for in the preceding **paragraph 3** with **25 %**.

**(5)** In administrative constructions of normal heights equipped with full-cover fire detection, signalling and alarm systems, smoke exhaust systems or installations and sprinkler extinguishing systems, an increase in the built-up areas of the groupings of office rooms referred to in paragraph 1 shall be permitted to increase the built-up areas of office rooms referred to in the preceding **paragraph 3** with **75 %**.

(6) Partitions between the groups of open, open space office rooms referred to in **paragraph 3**, as well as between them and other premises of the building, shall have the minimum classification (if the compliance conditions of the building and/or the density of the heat load in adjacent spaces do not produce higher performance) of walls of sectorization of fire spread (fire protection limiting propagation inside fire compartments) **(REI)** according to the classification of the construction/fire compartment to the fire stability level, according to **Article 3.1.3.3**.

(7) The groupings of open office rooms referred to in the preceding paragraphs shall have at least two separate and independent escape routes so arranged and constructed that they can be easily accessible to users.

(8) The groupings of open office rooms shall comply with the requirements set out in **Article 2.4.3.2**, paragraph 4 and **Article 2.5.14.1**.

**Article 3.2.2.5. (1)** In above-ground administrative buildings of normal heights, monumental stairs partially or throughout the height of the building shall be permitted in all cases where enclosures arranged and dimensioned in such a way that the normal conditions for the escape of users are ensured.

(2) Monumental stairs opened partially or throughout the building must not start in the space of open office space explained at **Article 3.2.2.4**.

**Article 3.2.2.6.** The reaction to fire of walls, doors and separation floors of enclosed staircases in above-ground administrative buildings of normal heights shall comply with the provisions of Table 57.

**Table 57: The reaction to fire of walls, doors and separation floors of enclosed staircases and doors in above-ground administrative buildings of normal heights**

Fire stability level	Permitted reaction to fire levels in closed stairways				
	Walls		Floors (separating the staircases from the rest of the construction)		Doors
<b>I</b> <i>h</i> ≥ 28m	<b>EI/REI 180</b>	<b>A1 or A2-s1d0</b>	<b>REI 120</b>	<b>A1 or A2-s1d0</b>	<b>E 60 - C5 S<sub>200</sub></b>
<b>II</b>	<b>EI/REI 180</b>	<b>A1 or A2-s1d0</b>	<b>REI 120</b>	<b>A1 or A2-s1d0</b>	<b>E 45 - C5 S<sub>200</sub></b>
<b>II (+)</b>	<b>EI/REI 120</b>	<b>A1 or A2-s1d0</b>	<b>REI 90</b>	<b>A1 or A2-s1d0</b>	<b>E 45 - C5 S<sub>200</sub></b>
<b>III</b>	<b>EI/REI 90</b>	<b>A1 or A2-s1d0</b>	<b>REI 60</b>	<b>A1 or A2-s1d0</b>	<b>E 30 - C5 Sa</b>
<b>III (+)</b>	<b>EI/REI 60</b>	<b>A1 or A2-s1d0</b>	<b>REI 45</b>	<b>A1 or A2-s1d0</b>	<b>E 30 - C5 Sa</b>
<b>IV</b>	<b>EI/REI 45</b>	<b>A1, A2-s1d0 or B-s1d0</b>	<b>REI 30</b>	<b>A1, A2-s1d0 or B-s1d0</b>	<b>C5</b>
<b>V</b>	<b>EI/REI 30</b>	<b>A1, A2-s1d0, B-s1d0, C-s1d0</b>	<b>REI 15</b>	<b>A1, A2-s1d0, B-s1d0, C-s1d0</b>	<b>-</b>

Notes:

‘-’ = no fire determined performance

(+) Construction works equipped with automatic sprinkler/spray fire-extinguishing systems in addition to the requirements of the specific technical regulations.

‘h’ = elevation of the last accessible/usable floor of the construction from the reference level

**Article 3.2.2.7.** The reaction to fire of walls, doors and separation boards of horizontal escape routes (corridors and halls) in administrative buildings of normal heights shall comply with the provisions of Table 58.

**Table 58: The reaction to fire of walls, doors and floors (corridors and halls) of horizontal escape**

**in above ground administrative buildings of ordinary heights**

Fire stability level	Permitted reaction to fire levels in corridors and halls				
	Walls		Floors (separating corridors and halls from the rest of the construction, including their exit paths to the land level or adjacent roads)	Doors (except those to closed staircases)	
<b>I</b> <i>h</i> ≥ 28m	EI/REI 90	A1 or A2-s1d0	<p><i>In accordance with Table 2, point 3</i></p> <p>The minimum fire resistance requirements to be met by the floors (REI) for compliance with the established fire stability level.</p>	A1 or A2-s1d0	E 30 – C5 S <sub>a</sub>
<b>II</b>	EI/REI 60	A1 or A2-s1d0		A1 or A2-s1d0	E15 – C5 S <sub>a</sub> or full doors of wood or metal
<b>II (+)</b>	EI/REI 60	A1 or A2-s1d0		A1 or A2-s1d0	E15 – C5 S <sub>a</sub> or full doors of wood or metal
<b>III</b>	EI/REI 45	A1 or A2-s1d0		A1 or A2-s1d0	C5
<b>III (+)</b>	EI/REI 45	A1 A2-s1d0		A1 or A2-s1d0,	C5
<b>IV</b>	EI/REI 30	A1 A2-s1d0, B-s1d0		A1 A2-s1d0, B-s1d0	C5
<b>V</b>	EI/REI 15	A1, A2-s1d0, B-s1d0, C-s1d0		A1, A2-s1d0, B-s1d0, C-s1d0	-

**Notes:**

‘-’ = no fire determined performance

(+) Construction works equipped with automatic sprinkler/spray fire-extinguishing systems in addition to the requirements of the specific technical regulations.

‘h’ = elevation of the last accessible/usable floor of the construction from the reference level

- a) In the case of glazed walls of metallic profile separating corridors from adjacent rooms, the reaction class to fire shall not be taken into account.

**Article 3.2.2.8.** The reaction to fire of walls, doors and separation floors of access (lobbies) in above-ground administrative buildings of normal heights shall comply with the provisions of Table 59.

**Table 59: The reaction to fire of walls, doors and separation floors of access halls (lobbying) in administrative above ground buildings of ordinary heights**

Fire stability level	Permitted reaction to fire levels in halls (building access lobbying)				
	Walls		Floors (separating corridors and halls from the rest of the construction, including their exit paths to the land level or adjacent roads)	Doors (except those to closed staircases)	
<b>I</b> <i>h</i> ≥ 28m	EI/REI 90	A1 or A2-s1d0	According to Table 2, point 3	A1 or A2-s1d0	E 30 - C5 S <sub>a</sub>



Fire stability level	Permitted reaction to fire levels in halls (building access lobbying)				
	Walls		Floors (separating corridors and halls from the rest of the construction, including their exit paths to the land level or adjacent roads)	Doors (except those to closed staircases)	
II	EI/REI 90	A1 or A2-s1d0	The minimum fire resistance requirements to be met by the floors (REI) for compliance with the established fire stability level.	A1 or A2-s1d0	E 30 - C5 Sa
II (+)	EI/REI 90	A1 or A2-s1d0		A1 sau A2-s1d0	E 30 - C5 Sa
III	EI/REI 60	A1 or A2-s1d0		A1 or A2-s1d0	E 15 - C5 Sa
III (+)	EI/REI 45	A1, A2-s1d0		A1 or A2-s1d0	E 15 - C5 Sa
IV	EI/REI 30	A1, A2-s1d0, B-s1d0		A1, A2-s1d0, B-s1d0	C5
V	EI/REI 15	A1, A2-s1d0, B-s1d0, C-s1d0		A1, A2-s1d0, B-s1d0, C-s1d0	-

**Notes:**

‘-’ = no fire determined performance

(+) Construction works equipped with automatic sprinkler/spray fire-extinguishing systems in addition to the requirements of the specific technical regulations.

‘h’ = elevation of the last accessible/usable floor of the construction from the reference level

a) In the case of glazed -metal walls separating corridors from adjacent rooms, the reaction class to fire shall not be taken into account.

**Article 3.2.2.9.** The maximum permissible escape length of the route on escape routes in administrative buildings (except for crowded rooms, high and very high buildings) is specified in **Table 60**.

**Table 60: Escape lengths in administrative above ground buildings of normal heights**

Reference No	Administrative buildings	Fire stability level provided	Maximum escape length		Remarks
			in two different directions	in a direction (dead-end corridor)	
			metres	metres	
1.	Central or local authority and institution buildings, financial-banking, trade unions, parties, offices, etc.	I and II	45	23	-
		III	30	16	
		IV	16	10	
		V	10	6	

**Note:**

In administrative buildings which are not crowded rooms, high buildings or very high buildings but are equipped with fire detection, signalling and alarm installations with total coverage, automatic fire extinguishing and smoke exhaust systems in horizontal common paths (corridors/halls) and staircases, the standardised escape lengths for users may increase by 25 %.

**Article 3.2.2.10. (1)** Above-ground administrative buildings of normal heights shall be provided with access to and intervention of extinguishing vehicles in the event of fire, at least on one side and at least on **25 %** of the perimeter of the external walls.

**(2)** In accordance with the maximum capacity of the administrative building at the same time, account must also be taken of the provisions of **Article 2.6.7.** paragraph **1, 2** and **3**.

### **3.2.3. Above-ground trade buildings**

**Article 3.2.3.1. (1)** Buildings for above-ground commerce, of normal heights such as shops, centres and shopping complexes, closed markets, catering (e.g. restaurants, bars, etc., as well as discotheque), casinos, provision of services (fitness, body maintenance, spa, veterinary practices), car workshop and similar services, children's play spaces, shall have the level of fire stability determined according to the provisions of **Article 2.1.3.2.** and Table 2.

**Article 3.2.3.2. (1)** Buildings for above-ground commerce with ordinary heights (shops, centres and shopping complexes, closed markets, catering, restaurants, bars, etc., as well as discotheque, casinos, provision of services, car servicing and similar services) shall comply with the provisions of the Rule and regulations specific to the respective destinations.

**(2)** Buildings or spaces with a commercial destination falling within the category of crowded rooms (shopping centres and complexes, super-shops, hypermarkets, restaurants, discotheque, etc.), or in high/very high buildings or underground, shall also comply with the specific conditions of these types of building. The construction of underground trade shall comply with the requirements of the specific legislation and the conditions laid down in this Rule. Commercial rooms arranged in the basement of above-ground buildings shall also comply with their specific conditions.

**Article 3.2.3.3. (1)** Above-ground commercial buildings of normal heights shall conform so as to meet the requirements for correlation between the destination, the fire stability level provided, the number of levels and the area of the fire compartment as specified in **Article 3.1.2.6., Article 3.1.2.7.** and Table 41 and Table 42 and Table, and in the event of the incorporation of commercial premises or rooms into buildings for other purposes, the provisions on performance specific to mixed-function buildings shall also be complied with, under the most stringent conditions.

**(2)** Commercial premises arranged in above-ground buildings, as well as those in the basement of above-ground buildings, shall be separated by vertical and horizontal fire resistant elements according to the provisions of the Rule.

**Article 3.2.3.4.** The minimum fire safety distances to be ensured between buildings for above-ground commerce with ordinary heights (shops, centres and shopping complexes, closed markets, catering, restaurants, bars, etc., as well as discotheque, casinos, services, automotive and similar services) and other buildings are laid down according to the provisions of **Article 2.2.1.2.** and Table 4.

**Article 3.2.3.5. (1)** In above-ground trade buildings and spaces with ordinary heights and maximum capacity at the same time greater than **200** users (persons), it is mandatory to evacuate smoke and hot gases in the event of fire by organised natural draught or by mechanical ventilation. In commercial areas developed on the basement of above-ground buildings with more than **50** users, the exhaust of smoke and hot gases in the event of fire, including related closed escape routes, is mandatory.

**(2)** Free aerodynamic surface of devices with automatic aperture for the exhaust of smoke and hot gases in case of fire by organised natural draught shall be at least **1 %** of the area of the above-ground room to be prevented with smoke and hot gas exhaust systems and minimum **2 %** to underground ones.

(3) When smoke exhaust is provided by mechanical ventilation, the provisions of the Rule and specific technical regulations shall be complied with.

**Article 3.2.3.6. (1)** Main storage rooms and food and non-food receptions related to commercial buildings or premises (above ground or underground) shall be subdivided from the rest of the building with fire-resistant elements corresponding to the density of their thermal load (q), but minimum **EI/REI 180** wall and minimum **REI 90** for floors.

(2) Operating and exhaust voids from these fire resistant partitions shall be protected by fire resistant and smoke tight closing elements **EI<sub>2</sub>90-C5S<sub>200</sub>**.

(3) Main storage rooms and food or non-food receptions with a surface area of more than 36 m<sup>2</sup>, with a high and very high fire risk, associated with commercial buildings or premises shall be provided with independent systems for the exhaust of smoke and hot gases by organised natural draught or by mechanical ventilation, according to the provisions of the Rule and specific technical regulations.

**Article 3.2.3.7. (1)** Storage rooms larger than 36 m<sup>2</sup> shall be separated from the surroundings by building elements having the fire performance prescribed in **Article 2.4.16.2(1)** but not less than **REI 180** for walls and **REI 90** for floors, respectively **EI<sub>2</sub> 90-C5 S<sub>200</sub>** for doors.

(2) Storage rooms smaller than 36 m<sup>2</sup> shall be separated from the surroundings by building elements having the fire performance prescribed in **Article 2.4.16.2(2)** but not less than **REI 120** for walls and **REI 60** for floors, i.e. **EI<sub>2</sub>60-C5S<sub>200</sub>** for doors.

(3) Storage rooms with a useful area larger than 36 m<sup>2</sup> and thermal load greater than 105 MJ/m<sup>2</sup> shall be provided with smoke and hot gas exhaust systems by organised natural draught or by mechanical ventilation, according to the provisions of the Rule and specific technical regulations. The total useful/aerodynamic area of the free area of devices with automatic smoke discharge aperture in the event of organised natural fire, shall be at least 1 % of the surface of the floor coverings. When smoke exhaust is provided by mechanical ventilation, the provisions of the Rule and/or technical regulations shall be complied with.

**Article 3.2.3.8. (1)** Hand-held warehouses related to sales rooms (representing maximum 20 % of the exposed products and the area of not more than 10 % of that of the sales room of the level business premises, but not more than 36 m<sup>2</sup>), may only be separated by furniture from publicly accessible spaces or non-fire-resistant functional walls.

(2) Smoke exhaust from the hand stores of sales rooms shall be carried out by means of smoke and hot gas exhaust systems by organised natural draught or by mechanical ventilation of sales rooms/commercial spaces (when these are provided with smoke and hot gas exhaust systems). Functional walls from hand warehouses associated with sales rooms shall be provided with empty at the side and the space bounded by the hand store through the functional walls shall be provided with air intake.

(3) Hand stores for each sales hall shall not exceed a maximum of 20 % of the exposed products and the area of not more than 10 %, but maximum 36 m<sup>2</sup>, from that of the sales room served. At a storage area larger than 36 m<sup>2</sup>, the provisions of **Article 3.2.3.7 (1)** and Table 21 shall apply.

**Article 3.2.3.9.** Larger sales premises of 200 m<sup>2</sup> intended for purchasers shall be separated from annex rooms which are not accessible to buyers (social or functional attachments, offices, etc.), by means of minimum fire-resistant walls **EI/REI 60** and, where appropriate, fire resistant floors **REI 60** and operating and exhaust voids in these walls shall be protected by minimum fire resistant fastenings **EI<sub>2</sub>30-C4 S<sub>200</sub>**. Enclosed rooms which are not accessible to purchasers shall be separated in the same way.

**Article 3.2.3.10. (1)** In sales premises in commercial buildings referred to in **Article 3.2.3.5. 1.** in which the smoke discharge cannot take place directly from the smoke tank (or the fire is in a

room adjacent to the space containing the tank or is below an enclosed mezzanine in the same space), equipped with fire detection, signalling and alarm systems with full cover, smoke exhaust and sprinkler extinguishing systems, it is permissible to replace fire resistant walls between sales spaces (except those mentioned in **Article 2.4.16.2**, **Article 3.2.3.6**. and **Article 3.2.3.7.**) with continuous screens of a height equal to that of the smoke tank, but not less than **1 m** (the smoke in the smoke tank shall not extend to neighbouring smoke areas), which shall be:

- **DH 90** – in civil above ground trade constructions with normal heights with fire stability level **I**

- **DH 60** – in civil above ground trade constructions with normal heights with fire stability level **II** and **III**

- **DH 30** – in civil above ground trade constructions with normal heights with fire stability level **IV**

(2) The maximum area of the smoke tank bounded by the screens specified in the preceding paragraph must be **1 000 m<sup>2</sup>** if there is a natural release of smoke or **1 300 m** if there are mechanical smoke discharge fans and the maximum length of the smoke tank shall not exceed **60 m**.

(3) Fire resistant walls between sales spaces and common escape paths (corridors and halls) in civil above ground trade constructions of normal heights may be replaced according to the relevant provisions of **Note b)** from **Table 62** and **Table 63**.

(4) Fire resistant walls between sales spaces and common vertical escape movements (enclosed staircases) in civil above-ground trade constructions of normal heights shall comply with **Table 61** but minimum **EI/REI 120** and, where appropriate, with minimum fire resistant floors **REI 90** and operating and exhaust voids in these walls shall be protected by minimum fire resistant closing elements **EI<sub>2</sub>60-C4S<sub>m</sub>**.

**Article 3.2.3.11. (1)** In sales premises in commercial buildings referred to in **Article 3.2.3.5. (1)** where smoke exhaust can take place directly from the smoke tank (the fire is directly below the smoke tank), equipped with fire detection, signalling and alarm systems with full cover, smoke exhaust and sprinkler extinguishing systems, it is permissible to replace fire resistant walls between sales spaces (except those mentioned in **Article 2.4.16.2**, **Article 3.2.3.6**. and **Article 3.2.3.7.**) with continuous screens of a height equal to that of the smoke tank, but not less than **1 m** (the smoke in the smoke tank shall not extend to neighbouring smoke areas), which shall be:

- **D<sub>600</sub> 90** – in civil above ground trade constructions with normal heights with fire stability level **I**

- **D<sub>600</sub> 60** – in civil above ground trade constructions with normal heights with fire stability level **II** and **III**

- **D<sub>600</sub> 30** – in civil above ground trade constructions with normal heights with fire stability level **IV**

(2) The maximum area of the smoke tank bounded by the screens specified in the preceding paragraph must be **1 000 m<sup>2</sup>** if there is a natural release of smoke or **1 300 m** if there are mechanical smoke discharge fans and the maximum length of the smoke tank shall not exceed **60 m**.

(3) Fire resistant walls between sales areas and common horizontal escape paths (corridors and halls) in civil above-ground trade constructions of normal heights may be replaced according to the relevant provisions of **Note b)** in **Table 62** and **Table 63**.

(4) Fire resistant walls between sales spaces and vertical common paths (escape staircases) in civil above-ground trade constructions of normal heights shall comply with **Table 61** but minimum **EI/REI 120** and operating and exhaust voids in these walls shall be protected by minimum fire resistant fastenings **EI<sub>2</sub>60-C4S<sub>m</sub>**.

**Article 3.2.3.12.** Above-ground trade buildings and fire compartments of normal heights and above-ground commercial rooms with a maximum capacity of more than **100** users as well as underground users with more than **60** users shall have a minimum of two escape routes.

**Article 3.2.3.13. (1)** Open internal stairways may be used in buildings for trade above normal heights, under the conditions laid down in the Rule, if enclosed escape staircases are also provided that meet the standard conditions.

**(2)** Irrespective of the number of open stairways provided in a commercial space bounded by walls and floors, they constitute a single route of escape for users of that space.

**Article 3.2.3.14. (1)** Explosive or violent combustion products (ammunition, pyrotechnic articles, etc.), liquefied gases and combustible liquids with a vapour flammability temperature below 28°C.

**(2)** Are exempted from **paragraph 1** cosmetics and pharmaceuticals packaged in bottles, as well as shops specially designed for the marketing of explosive or violent combustion products where specific fire safety measures are provided.

**Article 3.2.3.15.** The reaction to fire of walls, doors and floors separating enclosed staircases in buildings of normal height above ground trade shall comply with the provisions of Table 61.

**Table 61: The reaction to fire of walls, doors and floors separating enclosed staircases in buildings for above ground trade of ordinary heights**

Fire stability level	Permitted reaction to fire levels in closed stairways				
	Walls		Floors (separating the staircases from the rest of the construction)		Doors
<b>I</b> <i>h</i> ≥ 28m	<b>EI/REI 180</b>	<b>A1 or A2-s1d0</b>	<b>REI 120</b>	<b>A1 or A2-s1d0</b>	<b>E 60 – C5 S<sub>200</sub></b>
<b>II</b>	<b>EI/REI 180</b>	<b>A1 or A2-s1d0</b>	<b>REI 120</b>	<b>A1 or A2-s1d0</b>	<b>E 45 – C5 S<sub>200</sub></b>
<b>II (+)</b>	<b>EI/REI 120</b>	<b>A1 or A2-s1d0</b>	<b>REI 90</b>	<b>A1 or A2-s1d0</b>	<b>E 45 - C5 S<sub>200</sub></b>
<b>III</b>	<b>EI/REI 90</b>	<b>A1 or A2-s1d0</b>	<b>REI 60</b>	<b>A1 or A2-s1d0</b>	<b>E 30 - C5 Sa</b>
<b>III (+)</b>	<b>EI/REI 60</b>	<b>A1 or A2-s1d0</b>	<b>REI 45</b>	<b>A1 or A2-s1d0</b>	<b>E 30 - C5 Sa</b>
<b>IV</b>	<b>EI/REI 45</b>	<b>A1, A2-s1d0 or B-s1d0</b>	<b>REI 30</b>	<b>A1, A2-s1d0 or B-s1d0</b>	<b>E 15 - C5</b>
<b>V</b>	<b>EI/REI 30</b>	<b>A1, A2-s1d0, B-s1d0, C-s1d0</b>	<b>REI 15</b>	<b>A1, A2-s1d0, B-s1d0, C-s1d0</b>	<b>C5</b>

Notes:

(+) Construction works equipped with automatic sprinkler/spray fire-extinguishing systems in addition to the requirements of the specific technical regulations.

'h' = elevation of the last accessible/usable floor of the construction from the reference level

**Article 3.2.3.16.** The reaction to fire of walls, doors and floors separating horizontal escape routes (corridors) in above-ground trade buildings of normal heights shall comply with the provisions of Table 62.

**Table 62: The reaction to fire of walls, doors and floors separating horizontal escape (corridors) in above-ground trade buildings of normal heights**

Fire stability level	Permitted reaction to fire levels in corridors and halls				
	Walls		Floors (separating corridors and halls from the rest of the construction, including their exit paths to the land level or adjacent roads)	Doors (except those to closed staircases)	
<b>I</b> <i>h</i> ≥ 28m	<b>EI/REI 90</b>	<b>A1 or A2-s1d0</b>	<b>In accordance with Table 2, point 3</b> The minimum fire resistance requirements to be met by the floors (REI) for compliance with the established fire stability level.	<b>A1 or A2-s1d0</b>	<b>E 45 - C5 S<sub>a</sub></b>
<b>II</b>	<b>EI/REI 90</b>	<b>A1 or A2-s1d0</b>		<b>A1 or A2-s1d0</b>	<b>E 45 - C5 S<sub>a</sub></b>
<b>II (+)</b>	<b>EI/REI 60</b>	<b>A1 or A2-s1d0</b>		<b>A1 or A2-s1d0</b>	<b>E 30 - C5 S<sub>a</sub></b>
<b>III</b>	<b>EI/REI 45</b>	<b>A1 or A2-s1d0</b>		<b>A1 or A2-s1d0</b>	<b>E 15 - C5 S<sub>a</sub></b>
<b>III (+)</b>	<b>EI/REI 45</b>	<b>A1, A2-s1d0</b>		<b>A1 or A2-s1d0,</b>	<b>E 15 - C5 S<sub>a</sub></b>
<b>IV</b>	<b>EI/REI 30</b>	<b>A1, A2-s1d0, B-s1d0</b>		<b>A1, A2-s1d0, B-s1d0</b>	<b>E 15 - C5</b>
<b>V</b>	<b>EI/REI 15</b>	<b>A1, A2-s1d0, B-s1d0, C-s1d0</b>		<b>A1, A2-s1d0, B-s1d0, C-s1d0</b>	<b>-</b>

Notes:

**a)** - = no fire determined performance;

**(+)** Construction works equipped with automatic sprinkler/spray fire-extinguishing systems in addition to the requirements of the specific technical regulations.

**'h'** = elevation of the last accessible/usable floor of the construction from the reference level

**b)** in commercial buildings equipped with fire detection, signalling and alarm systems with full cover, smoke exhaust and sprinkler extinguishing systems, it shall be permitted to replace fire resistant walls and doors of corridors with a system similar to that of gap protection in floors consisting of sprinkler and screens **DH 60** minimum 1 m, with smoke exhaust and from spaces adjacent to the corridor;

**c)** in the case of glazed walls of metallic profile separating corridors from adjacent rooms, the reaction class to fire shall not be taken into account.

**Article 3.2.3.17.** The reaction to fire of the walls, doors and floors separating horizontal escape routes (halls) in above-ground trade buildings of normal heights shall comply with the provisions of Table 63.

**Table 63: The reaction to fire of walls, doors and floors separating horizontal escape routes (halls) in above-ground trade buildings of normal heights**

Fire stability level	Permitted reaction to fire levels in halls (main lobbying)				
	Walls		Floors (separating corridors and halls from the rest of the construction, including their outdoors to the land or adjacent roads)	Doors (except those to closed staircases)	
<b>I</b> <i>h</i> ≥ 28m	<b>EI/REI 90</b>	<b>A1 or A2-s1d0</b>	<b>In accordance with Table 2, point 3</b> The minimum fire resistance requirements to be met by the floors (REI) for compliance with the established	<b>A1 or A2-s1d0</b>	<b>E 45 - C5 S<sub>a</sub></b>
<b>II</b>	<b>EI/REI 90</b>	<b>A1 or A2-s1d0</b>		<b>A1 or A2-s1d0</b>	<b>E 45 - C5 S<sub>a</sub></b>
<b>II (+)</b>	<b>EI/REI 90</b>	<b>A1 or A2-s1d0</b>		<b>A1 or A2-s1d0</b>	<b>E 45 - C5 S<sub>a</sub></b>
<b>III</b>	<b>EI/REI 60</b>	<b>A1 or A2-s1d0</b>		<b>A1 or A2-s1d0</b>	<b>E 30 - C5 S<sub>a</sub></b>
<b>III (+)</b>	<b>EI/REI 45</b>	<b>A1, A2-s1d0</b>		<b>A1 or A2-s1d0</b>	<b>E 30 - C5 S<sub>a</sub></b>
<b>IV</b>	<b>EI/REI 30</b>	<b>A1, A2-s1d0, B-s1d0</b>		<b>A1, A2-s1d0, B-s1d0</b>	<b>E 15 - C5</b>
<b>V</b>	<b>EI/REI 15</b>	<b>A1, A2-s1d0, B-</b>		<b>A1, A2-s1d0, B-</b>	<b>-</b>

Fire stability level	Permitted reaction to fire levels in halls (main lobby)				
	Walls		Floors (separating corridors and halls from the rest of the construction, including their outdoors to the land or adjacent roads)		Doors (except those to closed staircases)
		s1d0, C-s1d0	fire stability level.	s1d0, C-s1d0	

Notes:

a) - = no fire determined performance;

(+) Construction works equipped with automatic sprinkler/spray fire-extinguishing systems in addition to the requirements of the specific technical regulations.

'h' = elevation of the last accessible/usable floor of the construction from the reference level

b) in commercial buildings equipped with fire detection, signalling and alarm systems with full cover, smoke exhaust and sprinkler extinguishing systems, it shall be permitted to replace fire-resistant walls and doors of halls with a system similar to that of gap protection in floors consisting of sprinkler and screens **DH 90** having a height equal to that of the smoke tank, but not less than **1 m**, when smoke exhaust takes place and from spaces adjacent to the corridor.

c) in the case of glazed walls of metal profile separating halls from adjacent rooms, the reaction to fire class shall not be taken into account.

**Article 3.2.3.18.** Functional and escape routes for users of construction works and underground commercial premises with a maximum simultaneous capacity greater than **100** users shall be independent of the escape routes of the above ground levels to another destination, and communication between them shall only be permitted through protected buffer rooms ventilated under excess pressure.

**Article 3.2.3.19.** The maximum permissible escape length of the journey through escape routes in commercial buildings (excluding crowded rooms, high and very high buildings) is specified in **Table 64**.

**Table 64: Escape lengths in buildings for trade above ground of normal heights**

Reference No	Commercial buildings	Fire stability level provided	Maximum escape length		Remarks
			in two different directions	in a direction (dead-end corridor)	
			metres	metres	
1.	Shops, catering, exhibitions, etc.	<b>I and II</b>	<b>42</b>	<b>21</b>	-
		<b>III</b>	<b>21</b>	<b>15</b>	
		<b>IV</b>	<b>15</b>	<b>10</b>	
		<b>V</b>	<b>10</b>	<b>6</b>	

Note:

1. in commercial buildings which are not crowded rooms, high buildings or very high buildings but are equipped with fully covered fire-detection, signalling and alarm installations, automatic fire extinguishing systems and smoke escape systems in horizontal common paths (hall and corridors), staircases as well as in spaces adjacent to corridors, user escape lengths may be increased by **25 %**.

**Article 3.2.3.20. (1)** Above-ground commercial buildings of normal heights shall have access to and intervention routes for fire-extinguishing vehicles, at least in full on two (2) adjacent sides and at least on **50 %** from the perimeter of the external walls

**(2)** In accordance with the maximum simultaneous capacity of the building for commerce, account must also be taken of the provisions of **Article 2.6.7.** paragraphs **1, 2** and **3**.

### **3.2.4. Above-ground health buildings**

**Article 3.2.4.1. (1)** Above-ground health buildings of ordinary heights (hospitals, polyclinics, crèches, retirement homes and disabled people, sanatoria, etc.), medical diagnostic and treatment centres, multifunctional medical and health centres, clinics and outpatient medical units similar to polyclinics, shall be compliant in such a way as to meet the conditions for correlation between the destination, the level of fire stability provided, the area built up (**Ac**) and number of levels, as set out in **Article 3.1.2.6.**, **Article 3.1.2.7.** and Table 41 and Table 42.

**(2)** Crèches shall be designed according to the provisions of the specific legislation.

**(3)** Health buildings intended for persons who cannot evacuate themselves must meet the criteria for classification in the level of **I** or **II** of fire stability.

**Article 3.2.4.2. (1)** Health buildings on the ground floor, with built-up area (**Ad**) greater than **600 m<sup>2</sup>** and floors (regardless of the area) shall have a minimum of two escape routes for users.

**(2)** In health buildings in which persons who need to be evacuated by stretcher or wheelchairs in the event of fire are hospitalised, staircases with curved ramps or swung steps shall be prohibited.

**(3)** Closed staircases shall, as far as possible, be naturally illuminated.

**Article 3.2.4.3. (1)** In above-ground health buildings of normal heights in which the escape of users in the event of fire is to be carried out with a roller bed, stretcher or wheelchairs, the free widths of the functional and escape routes, vertical and horizontal, shall be at least:

- a.** **1.05 m** for doors in sick lounges;
- b.** **1.40 m** in operating theatres and routes on which sick persons are being carried on the stretcher;
- c.** **90 cm** at diagnostic premises – treatment;
- d.** **70 cm** in sanitary groups for non-disabled patients;
- e.** **80 cm** -to toilet facilities for people with disabilities;
- f.** **2.20 m** -for stretcher transport and **2.40 m** -for roller bed transport of main corridors in care, diagnosis and treatment facilities;
- g.** **2.40 m** -waiting on one side and **3.50 m** -waiting on two sides of corridors with waiting areas along walls
- h.** **1.40 m** for ramps of staircases and sloping planes, with slopes/floors of **2.20 m** depth corresponding to the escape of a flow (stretcher);
- i.** **2.20 m** for ramps of staircases and sloping planes, with slopes/floors of **2.60 m** depth corresponding to the escape of two flows (with stretcher);
- j.** **2.50 m (3.30 m depth)** for spaces in front of lifts arranged on one side, and **2.50 m** normal (advisable **3.00 m** width/**5.40 m** depth) when lifts are put forward in front.

**(2)** Lift booths provided for the transport of patients by roller bed, stretcher or wheelchairs or disabled persons which may also be used for their assisted escape in the event of fire shall have a minimum width of **2.20 m** and length of minimum **2.70 m** corresponding to the escape of two stretchers and a minimum width **1.80 m** and length of minimum **2.70 m** corresponding to the evacuation of a stretcher.

**(3)** The free heights of passage on common escape routes (corridors, halls, buffer rooms, protected clearance, stairways, escape tunnels, etc.) shall not be less than **2.20 m**.

**(4)** The conditions laid down in the Rule shall be complied with for functional traffic and escape routes in the event of a fire of patients which may move on their own.

**(5)** On the common horizontal escape routes (corridors, halls), it is permissible to provide for fixed furniture elements under the conditions laid down in **Article 2.5.2.1 paragraphs 5 and 6**.

**(6)** No furniture objects (fuel or non-combustible) may be placed in the enclosure of escape staircases, protected escape, buffer rooms, escape tunnels, etc. in health buildings.



**Article 3.2.4.4. (1)** Depending on the number of levels of the building for health above normal height and the number of transportable patients with the stretcher or wheelchairs, the lifts intended to be functionally separated, constructed and electrically powered, so that they can be used by emergency personnel and for the assisted escape of the sick in the event of fire.

**(2)** Lifts used for the assisted escape of patients in the event of fire shall meet the requirements for common performance.

**(3)** Gaps in access to passenger lifts and lifts intended for the carriage of patients with a roller bed, stretcher or wheelchairs or disabled persons in civil health buildings of normal height shall be protected according to the provisions of the provisions of **Article 2.4.4.2.5**.

**(4)** Where the gaps of access to passenger lifts and lifts intended for the transport of patients by roller bed, stretcher or wheelchairs, or disabled persons in normal civil health constructions, start in smoke shielded spaces (staircases provided with excess pressure or smoke discharge, protected buffer rooms, protected escape or protected corridors with air inlet and smoke discharge or overpressure), it is not necessary to provide fire resistance performance to the access gaps provided for in the preceding **paragraph 4**.

**(5)** Lifts for the transport of patients with a roller bed, stretcher or wheelchairs or disabled persons who may also be used for their assisted escape in the event of fire shall be provided for in the cases laid down in the Rule and specific technical regulations, mandatory for health buildings with persons who cannot evacuate themselves (defined according to terminology).

**(6)** In civil health buildings of normal height, lifts for the transport of patients with stretchers or wheelchairs or disabled persons may also be used for their assisted escape in the event of fire when they comply simultaneously with the following conditions:

**a)** they are provided with their own well equipped with an overpressure installation separate from the rest of the construction with the fire class reaction class; **A1** or **A2-s1d0** minimum fire resistant **EI/REI 90** and floors reaction to fire class **A1** or **A2-s1d0** minimum fire resistant **REI 90**;

**b)** have ensured operation for a minimum **90** minutes after the outbreak of the fire;

**c)** comply with the provisions of **Article 3.1.4.4 (3) points (c), (d), (e), (f) and (g)**.

**(7)** Access to lifts provided for the transport of patients by roller bed, stretcher or wheelchairs or disabled persons which may also be used for their assisted escape in the event of fire at the above-ground levels of civil health buildings of normal height shall be provided by:

– fire resistant landing doors **EI 90** when they start in smoke free spaces (protected escape or protected corridors with excess pressure or air inlet and mechanical smoke discharge); in this case the spaces in which the doors of the lifts are opened shall be provided with walls of the reaction class fire reaction class **A1** or **A2-s1d0**, fire resistant minimum **EI/REI 90** and doors minimum **EI<sub>2</sub>30-C5S<sub>200</sub>**;

– construction of buffer rooms ventilated under excess pressure, fitted with fire and smoke tight doors as a minimum **E30-C5S<sub>200</sub>** towards horizontal common paths and fire resistant doors **EI90** in lifts doors; in this case, the ventilated buffer room in over pressure shall be provided with fire walls in class **A1** or **A2-s1d0**, fire resistant minimum **EI/REI 90**.

**(8)** Access to lifts provided for the transport of patients by roller bed, stretcher or wheelchairs or disabled persons which may also be used for their assisted escape in the event of fire at the underground levels of civil health buildings of normal height shall be ensured by the provision of buffer rooms ventilated under excess pressure, fitted with fire resistant doors and smoke tight doors **EI<sub>2</sub>60-C5S<sub>200</sub>** towards horizontal common paths and fire resistant doors **EI90** in lifts doors; in this case, the ventilated buffer room in over pressure shall be provided with fire walls in class **A1** or **A2-s1d0**, fire resistant minimum **EI/REI 90**.

(9) If the lifts which can also be used for the assisted escape of patients with a roller bed, stretcher or wheelchairs or disabled persons have a two-access cab, all specified gaps must meet the conditions of **paragraph 7** and **paragraph 8**.

(10) When gaps of access to passenger lifts and lifts intended for the carriage of patients with a roller bed, stretcher or wheelchairs or disabled persons which may also be used for their assisted escape in the event of fire at the above-ground and/or underground levels of civil health buildings of normal height, start in a common space, all doors in lifts shall be **EI90** and the spaces in which they start shall be provided with fire resistant and smoke tight doors **EI30** above ground and **EI60** underground.

(11) When gaps of access to the escape staircases of persons and to lifts provided for the transport of patients with a roller bed, stretcher or wheelchairs or disabled persons which may also be used for their assisted escape in the event of fire at the above-ground and/or underground levels of civilian health buildings of normal height start in a common space, all doors in lifts shall be **EI90** and the door at the staircase shall be **EI<sub>2</sub>90-C5S<sub>200</sub>**.

(12) Lifts intended for the transport of patients with a roller bed, stretcher or wheelchairs or of disabled persons which may also be used for their assisted escape in the event of fire from civil health buildings of normal height shall have controls in corridors or protected openings.

(13) Specific provisions shall be complied with in high, very high health buildings and those with crowded rooms.

**Article 3.2.4.5.** The reaction to fire of walls, doors and floors separating enclosed staircases and doors in above-ground health buildings of normal heights shall comply with the provisions of Table 65.

**Table 65: The reaction to fire of walls, doors and floors separating enclosed staircases in above-ground health buildings of normal heights**

Fire stability level	Permitted reaction to fire levels in closed stairways				
	Walls		Floors (separating the staircases from the rest of the construction)		Doors
<b>I</b> <i>h</i> ≥ 28m	<b>EI/REI 180</b>	<b>A1 or A2-s1d0</b>	<b>REI 120</b>	<b>A1 or A2-s1d0</b>	<b>E 60 – C5 S<sub>200</sub></b>
<b>II</b>	<b>EI/REI 180</b>	<b>A1 or A2-s1d0</b>	<b>REI 120</b>	<b>A1 or A2-s1d0</b>	<b>E 45 – C5 S<sub>200</sub></b>
<b>II (+)</b>	<b>EI/REI 120</b>	<b>A1 or A2-s1d0</b>	<b>REI 90</b>	<b>A1 or A2-s1d0</b>	<b>E 45 – C5 S<sub>200</sub></b>
<b>III</b>	<b>EI/REI 90</b>	<b>A1 or A2-s1d0</b>	<b>REI 60</b>	<b>A1 or A2-s1d0</b>	<b>E 30 – C5 Sa</b>
<b>III (+)</b>	<b>EI/REI 60</b>	<b>A1 or A2-s1d0</b>	<b>REI 45</b>	<b>A1 or A2-s1d0</b>	<b>E 30 – C5 Sa</b>
<b>IV</b>	<b>EI/REI 60</b>	<b>A1, A2-s1d0 or B-s1d0</b>	<b>REI 30</b>	<b>A1, A2-s1d0 or B-s1d0</b>	<b>E 15 - C5 Sa</b>
<b>V</b>	<b>Not permitted</b>	<b>Not permitted</b>	<b>Not permitted</b>	<b>Not permitted</b>	<b>Not permitted</b>

Notes:

(+) Construction works equipped with automatic sprinkler/spray fire-extinguishing systems in addition to the requirements of the specific technical regulations.

'h' = elevation of the last accessible/usable floor of the construction from the reference level

**Article 3.2.4.6.** The reaction to fire of walls, doors and floors separating horizontal escape routes (corridors and halls) in above-ground health buildings of normal heights shall comply with the provisions of Table 66.

**Table 66: The reaction to fire of walls, doors and floors separating horizontal escape routes**

**(corridors and hall) in health buildings of above ground normal heights**

Fire stability level	Permitted reaction to fire levels in corridors and halls				
	Walls		Floors (separating corridors and halls from the rest of the construction, including their exit paths to the land level or adjacent roads)	Doors	
<b>I</b> <i>h</i> ≥ 28m	<b>EI/REI 90</b>	<b>A1 or A2-s1d0</b>	<b>In accordance with Table 2, point 3</b> The minimum fire resistance requirements to be met by the floors (REI) for compliance with the established fire stability level.	<b>A1 or A2-s1d0</b>	<b>C5 Sa</b>
<b>II</b>	<b>EI/REI 90</b>	<b>A1 or A2-s1d0</b>		<b>A1 or A2-s1d0</b>	<b>C5 Sa</b>
<b>II (+)</b>	<b>EI/REI 90</b>	<b>A1 or A2-s1d0</b>		<b>A1 sau A2-s1d0</b>	<b>C5 Sa</b>
<b>III</b>	<b>EI/REI 60</b>	<b>A1 or A2-s1d0</b>		<b>A1 or A2-s1d0</b>	<b>C5 Sa</b>
<b>III (+)</b>	<b>EI/REI 45</b>	<b>A1, A2-s1d0</b>		<b>A1 sau A2-s1d0</b>	<b>C5 Sa</b>
<b>IV</b>	<b>EI/REI 30</b>	<b>A1, A2-s1d0, B-s1d0</b>		<b>A1, A2-s1d0, B-s1d0</b>	<b>C5 Sa</b>
<b>V</b>	<b>EI/REI 15</b>	<b>A1, A2-s1d0, B-s1d0</b>		<b>A1, A2-s1d0, B-s1d0</b>	<b>C5</b>

Notes:

‘-’ = no fire determined performance

(+) Construction works equipped with automatic sprinkler/spray fire-extinguishing systems in addition to the requirements of the specific technical regulations.

‘h’ = elevation of the last accessible/usable floor of the construction from the reference level

In the case of glazed metal walls separating corridors and halls from adjacent rooms, the reaction to fire class shall not be taken into account.

**Article 3.2.4.7. (1)** Finishes, treatment and thermal and sound-insulation in health building rooms must be predominantly **A1, A2-s1, d0** for the level **I, II** and **III** of fire stability, predominantly **A1, A2-s1, d0** and **B-s1, d0** for the level **IV** and **V** of fire stability.

**(2)** By way of exception to the provisions of **paragraph 1** in health buildings the use of combustible finishes at minimum walls is permitted **B-s2d0**, bonded to non-combustible surface, i.e. minimum floor coverings **B<sub>f</sub> -s1**, bonded to the non-combustible surface, including escape routes.

**Article 3.2.4.8.** The maximum permissible escape length of the journey through escape routes in health buildings (excluding crowded rooms, high and very high buildings) shall also be ensured taking into account the need to transport the sick people with a stretcher or wheelchairs as provided for in **Table 67** and **Table 68**.

**Table 67: Escape lengths in above-ground health buildings of normal heights (where the transport of sufferers by stretcher or wheelchairs is required)**

Reference No	Health buildings	Fire stability level provided	Maximum escape length		Remarks
			in two different directions	in a direction (dead-end corridor)	
			metres	metres	
1.	Hospitals, polyclinics, diagnostic and treatment medical centres,	<b>I and II</b>	<b>38</b>	<b>18</b>	For constructions with normal health heights where it is not
		<b>III</b>	<b>18</b>	<b>12</b>	
		<b>IV</b>	<b>12</b>	<b>8</b>	

	<i>multifunctional health and medical centres, clinics and outpatient medical facilities similar to polyclinics, sanatoria, old people's homes and people with disabilities, etc.</i>	<b>V*</b>	<b>8</b>	<b>6</b>	<i>necessary to transport the sick people by stretcher or wheelchair, the values in Table 68 shall be complied with.</i>
--	---	-----------	----------	----------	--

Notes:

a) In above-ground health buildings of ordinary heights (where the carriage of sufferers by stretcher or wheelchairs is required) which are not crowded rooms, high buildings or very high buildings, but are equipped with full-cover fire detection, signalling and alarm installations, automatic fire-fighting systems and smoke exhaust systems in common horizontal paths (halls and corridors) and staircases, the standardised escape lengths for users of building sectors (i.e. by means of fire safety elements according to the requirements of Table 45) which are accessible only to service, maintenance, administrative and security/surveillance personnel (except those used by the sick) may be increased by 25 %.

\* = ground floor buildings only

**Table 68: Escape lengths in buildings for health above normal heights (where the carriage of sufferers by stretcher or wheelchairs is not required)**

Reference No	Health buildings	Fire stability level provided	Maximum escape length		Remarks
			in two different directions	in a direction (dead-end corridor)	
			metres	metres	
1.	<i>Hospitals, polyclinics, diagnostic and treatment medical centres, multifunctional health and medical centres, clinics and outpatient medical facilities similar to polyclinics, sanatoria, old people's homes and people with disabilities, etc.</i>	<b>I and II</b>	<b>40</b>	<b>20</b>	-
		<b>III</b>	<b>24</b>	<b>16</b>	
		<b>IV</b>	<b>15</b>	<b>10</b>	
		<b>V*</b>	<b>10</b>	<b>6</b>	

Notes:

a) In buildings or sectors of buildings for health above ground heights (where **no** transport of patients with stretchers or wheelchairs is required) which are not crowded rooms, high buildings or very high buildings but are equipped with fully covered fire detection, signalling and alarm systems, automatic fire-fighting systems and smoke exhaust systems in common horizontal paths (halls and corridors) and staircase, standardised escape lengths of users of building sectors (segmentation is done by means of fire safety elements according to the requirements of Table 45), standardised escape lengths may be increased by 25 %.

\* = ground floor buildings only

**Article 3.2.4.9. (1)** In above-ground civil health buildings of normal heights, the rooms shall be separated from the rest of the construction according to the provisions on common and specific performance and, where the standard does not provide, internal partition walls designed to limit the propagation of fire according to the **Article 2.1.3.2.** and Table 2.

**(2)** In open space groupings (open workspaces for activities requiring frequent communication) which are not used by persons who cannot evacuate themselves defined according to terminology (administrative spaces as well as staff changing rooms, included in the health function) with the maximum standardised area of low fire risk and the same destination (own or complementary/spaces and functional movement bounded by functional bulkheads, panels or internal walls), a minimum of sectoral partitions shall be provided to limit the propagation of fire to adjacent spaces (excluding those to escape routes complying with specific provisions and those to

rooms with a higher risk arising from the density of the heat load in adjacent heads), which shall be the reaction to fire class minimum **A1, A2-s1, d0**:

- a) **EI/REI 120** fitted with fire resistant and smoke tight doors **EI<sub>2</sub> 60-C5S<sub>200</sub>** in above-ground civil health constructions with normal heights having fire stability level **I**;
- b) **EI/REI 90** fitted with fire resistant and smoke tight doors **EI<sub>2</sub> 45-C5S<sub>200</sub>** in above-ground civil health constructions with normal heights having fire stability level **II**;
- c) **EI/REI 60** fitted with fire tight and smoke tight doors **E 30-C5S<sub>a</sub>** in above-ground civil health constructions with normal heights having fire stability level **III**;
- d) **EI/REI 30** fitted with fire tight and smoke tight doors **E 15-C5S<sub>a</sub>** in above-ground civil health constructions with normal heights having fire stability level **IV**;
- e) **EI/REI 15** fitted with doors **C5** in above-ground civil health constructions with normal heights having fire stability level **V**.

(3) Groupings of rooms with low fire risk and the same destination, including collateral destinations, including horizontal functional communications (such as changing rooms + toilet facilities; desks + lock chamber access) as well as those specific to the health function (MRI room + command room + lock chamber access; CT room + control room + lock chamber access, etc.) partitioned between them by opaque or glazed panels, fixed or movable, used as functional separation and/or sound insulation or functional internal walls or partitions, shall be permitted within the following areas constructed in health engineering of normal heights:

- maximum **600 m<sup>2</sup>**, provided that the built area of the open space type of rooms not exceeding **50 %** of that of the built-up area of the building level/fire compartment concerned for health buildings falling within the level **I** of fire stability;
- maximum **400 m<sup>2</sup>**, provided that the built area of the type of rooms open space not exceeding **50 %** of that of the built-up area of the building level/fire compartment concerned for health buildings within level **II** of fire stability;
- maximum **200 m<sup>2</sup>**, provided that the built area of the type of rooms open space not exceeding **50 %** of that of the built-up area of the building level/fire compartment concerned for health buildings within level **III** of fire stability;
- maximum **100 m<sup>2</sup>**, provided that the built area of the open space type of rooms not exceeding **25 %** of that of the built-up area of the building level/fire compartment concerned for health buildings within level **IV** of fire stability;
- maximum **50 m<sup>2</sup>**, provided that the built area of the open space type of rooms not exceeding **25 %** of that of the built-up area of the building level/fire compartment concerned for health buildings within level **V** of fire stability;

(4) In health buildings of normal heights equipped with fire detection, signalling and alarm systems with total cover, smoke exhaust systems or installations and sprinkler extinguishing systems, it shall be permissible to increase the built-up areas of the groupings of rooms provided for in the preceding **paragraph 3** with **25 %**.

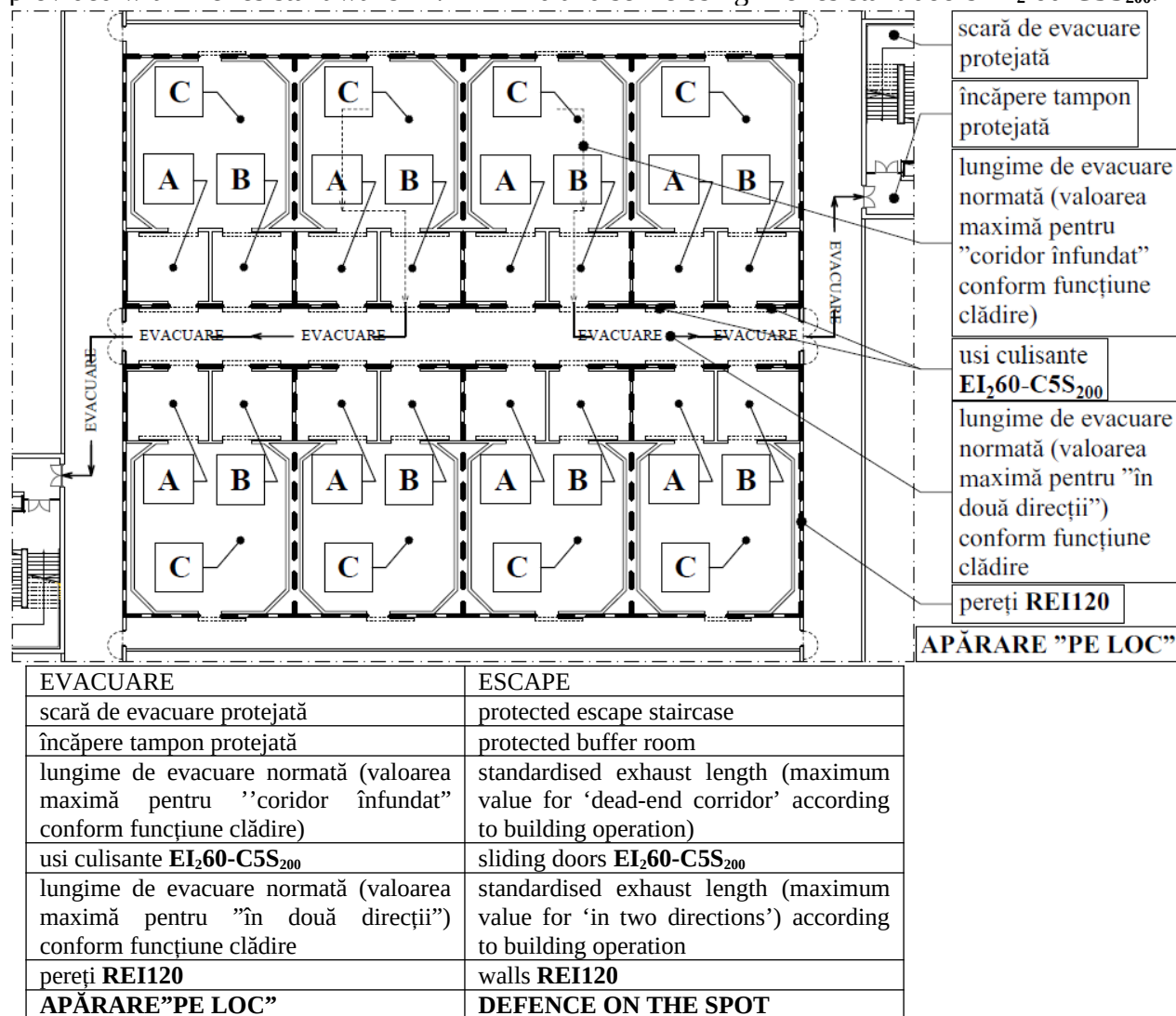
(5) Partitions between the groupings of rooms referred to in **paragraph 3**, as well as between them and other building spaces (border lined from common escape paths – corridors, protected release, buffer rooms ventilated in excess pressure, stairway enclosure, etc., as well as spaces of different fire risk – according to the densities of heat loads (q) in adjacent spaces and/or densities of heat loads (q) the largest in the spaces they split and/or those with different fire risk from operation), shall have the reaction class to fire **A1** or **A2s1d0** and the minimum fire resistance classification (if the heat load density in adjacent spaces does not produce higher performance) of walls by containment of fire spread (fire protection limiting propagation inside fire compartments) (**REI**), according to the classification of the construction/fire compartment to the fire stability level specified in **Table 2 reference No 5**.

(6) Spaces of the same type used by persons who cannot be evacuated on their own in health buildings [hospital or hospital buildings – hospitals, maternities, polyclinics, parks, dispensaries, multifunctional medical and health centres, clinics and outpatient medical units similar to

polyclinics, diagnostic and treatment medical centres, nursing homes or homes for elderly people and disabled people, mental patients hospices, sanatoria, etc.)] constituted in open room groupings, are not allowed, subject to the exceptions specified.

(7) Sleeping or hospitalisation rooms (hospital rooms, reserves, medical practices, etc.), except those requiring permanent surveillance (ATI, UPU, etc.), may not be formed into open-space groupings and they must be separated between them by minimum internal partitions designed to limit the spread of fire (EI) according to stability of the construction/fire compartment (if the function or density of heat load in adjacent spaces does not produce higher performance).

(8) Mandatory chambers of operations together with their collateral destinations (washers, hand stores of specific medical instrumentation, etc.) as described in Figure 68, as well as premises requiring permanent surveillance (ATI) and advisable to other rooms (UPUs, etc.), shall be formed each in the open space grouping within the area specified in **Article 3.2.4.9 (3)** and shall be provided with fire resistant walls **EI/REI 120** and self-closing fire resistant doors **EI<sub>2</sub> 60-C5S<sub>200</sub>**.



**Figure 68 – The concept of defence on the spot**

**Legend Figure 69 (example principle):**

A – medical laundry; B – sick persons access, etc.; C – operation room

**Article 3.2.4.10.** High or very high health buildings and busy buildings shall also comply with their specific performance provisions.

**Article 3.2.4.11. (1)** Above ground health buildings of normal height and hospitalisation places shall have access and intervention routes to extinguishing vehicles in the event of fire, at least in full on two (2) adjacent sides and at least on **50 %** of the perimeter of the external walls.

**(2)** Above-ground health buildings of normal height without hospitalisation shall have access to and intervention of fire extinguishing vehicles, at least on one side and at least on **25 %** from the perimeter of the external walls.

**(3)** In accordance with the maximum capacity of the building for health at the same time, account must also be taken of the provisions of **Article 2.6.7.** paragraph **1** and **2.**

### **3.2.5. Above ground buildings for culture**

**Article 3.2.5.1. (1)** Buildings for above-ground culture with ordinary heights (exhibitions, museums, libraries, clubs, rooms, cultural centres and complexes, cinemas, theatres, multipurpose rooms, etc.) shall comply in such a way as to meet the conditions for correlation between the destination, the level of fire stability provided, the area built up ( $A_c$ ) and the number of levels, as provided for in **Article 3.1.2.6.**, **Article 3.1.2.7.** and Table 41 and Table 42.

**(2)** It is recommended that, by making up the constructions for culture, to ensure the fire stability levels **I**, **II** or **III**, depending on the number of users, the importance of the buildings and the heritage values housed.

**Article 3.2.5.2.** The escape routes of users in the event of fire from buildings for above-ground culture with normal heights shall meet the standard conditions corresponding to the level of fire stability provided, the maximum number of users simultaneously and the intended use.

**Article 3.2.5.3.** The reaction to fire of walls, doors and separation floors of enclosed staircases in above-ground growing buildings of normal heights shall comply with the provisions of Table 69.

**Table 69: The reaction to fire of walls, doors and floors separating enclosed staircases in above-ground culture buildings of normal heights**

<b>Fire stability level</b>	<b>Permitted reaction to fire levels in closed stairways</b>				
	<b>Walls</b>		<b>Floors (separating the staircases from the rest of the construction)</b>		<b>Doors</b>
<b>I</b> $h \geq 28m$	<b>EI/REI 180</b>	<b>A1 or A2-s1d0</b>	<b>REI 120</b>	<b>A1 or A2-s1d0</b>	<b>E 60 - C5 S<sub>200</sub></b>
<b>II</b>	<b>EI/REI 180</b>	<b>A1 or A2-s1d0</b>	<b>REI 120</b>	<b>A1 or A2-s1d0</b>	<b>E 45 - C5 S<sub>200</sub></b>
<b>II (+)</b>	<b>EI/REI 120</b>	<b>A1 or A2-s1d0</b>	<b>REI 90</b>	<b>A1 or A2-s1d0</b>	<b>E 45 - C5 S<sub>200</sub></b>
<b>III</b>	<b>EI/REI 90</b>	<b>A1 or A2-s1d0</b>	<b>REI 60</b>	<b>A1 or A2-s1d0</b>	<b>E 30 - C5 Sa</b>
<b>III (+)</b>	<b>EI/REI 60</b>	<b>A1 or A2-s1d0</b>	<b>REI 45</b>	<b>A1 or A2-s1d0</b>	<b>E 30 - C5 Sa</b>
<b>IV</b>	<b>EI/REI 45</b>	<b>A1, A2-s1d0 or B-s1d0</b>	<b>REI 30</b>	<b>A1, A2-s1d0 or B-s1d0</b>	<b>E 15 - C5 Sa</b>
<b>V</b>	<b>EI/REI 30</b>	<b>A1, A2-s1d0, B-s1d0, C-s1d0</b>	<b>REI 15</b>	<b>A1, A2-s1d0, B-s1d0, C-s1d0</b>	<b>C5</b>

Notes:

(+) Construction works equipped with automatic sprinkler/spray fire-extinguishing systems in addition to the requirements of the specific technical regulations.

'h' = elevation of the last accessible/usable floor of the construction from the reference level

**Article 3.2.5.4.** The reaction to fire of walls, doors and floors separating horizontal escape routes (corridors and halls) in above-ground culture buildings of normal heights shall comply with the provisions of Table 70.

**Table 70: The reaction to fire of walls, doors and floors separating horizontal escape routes (corridors and halls) in above-ground culture buildings with normal heights**

Fire stability level	Permitted reaction to fire levels in corridors and halls				
	Walls		Floors (separating corridors and halls from the rest of the construction, including their exit paths to the land level or adjacent roads)	Doors (except those to closed staircases)	
<b>I</b> <i>h</i> ≥ 28m	<b>EI/REI 90</b>	<b>A1 or A2-s1d0</b>	<b>In accordance with Table 2, point 3</b> The minimum fire resistance requirements to be met by the floors (REI) for compliance with the established fire stability level.	<b>A1 or A2-s1d0</b>	<b>E 30 - C5 S<sub>200</sub></b>
<b>II</b>	<b>EI/REI 90</b>	<b>A1 or A2-s1d0</b>		<b>A1 or A2-s1d0</b>	<b>E15 - C5 S<sub>a</sub> or full doors of wood or metal</b>
<b>II (+)</b>	<b>EI/REI 90</b>	<b>A1 or A2-s1d0</b>		<b>A1 or A2-s1d0</b>	<b>E15 - C5 S<sub>a</sub> or full doors of wood or metal</b>
<b>III</b>	<b>EI/REI 60</b>	<b>A1 or A2-s1d0</b>		<b>A1 or A2-s1d0</b>	<b>C5</b>
<b>III (+)</b>	<b>EI/REI 45</b>	<b>A1 A2-s1d0</b>		<b>A1 or A2-s1d0</b>	<b>C5</b>
<b>IV</b>	<b>EI/REI 30</b>	<b>A1, A2-s1d0, B-s1d0</b>		<b>A1, A2-s1d0, B-s1d0</b>	<b>C5</b>
<b>V</b>	<b>EI/REI 15</b>	<b>A1, A2-s1d0, B-s1d0, C-s1d0</b>		<b>A1, A2-s1d0, B-s1d0, C-s1d0</b>	<b>-</b>

**Notes:**

In the case of glazed metal walls separating corridors and halls from adjacent rooms, the reaction to fire class shall not be taken into account.

(+) Construction works equipped with automatic sprinkler/spray fire-extinguishing systems in addition to the requirements of the specific technical regulations.

'h' = elevation of the last accessible/usable floor of the construction from the reference level

**Article 3.2.5.5.** Above-ground culture buildings with normal heights, fire compartments and above-ground rooms with a maximum capacity of more than **100** users, as well as underground ones with more than the maximum simultaneous capacity of **60** users shall have a minimum of two escape routes in the event of fire.

**Article 3.2.5.6.** Publicly accessible spaces in above-ground culture buildings and user functional and escape routes shall be separated from the accompanying and technical rooms by walls **REI** and floors **REI** with fire resistances corresponding to the purpose and density of heat load (q) in adjacent rooms, but not less than those referred to in Table 71.

**Table 71: Separation elements (walls and floors) in buildings for above-ground culture with ordinary heights**

Reference No	Purpose of the element	Fire stability level of the building	Minimum strength conditions (minutes)		Remarks
			Walls	Floors	
1.	Separation elements of rooms in which the public has access from	<b>I</b>	<b>EI/REI 120</b>	<b>REI 120</b>	Underground car parks for passenger cars shall be separated from the above-
		<b>II</b>	<b>EI/REI 90</b>	<b>REI 60</b>	
		<b>III</b>	<b>EI/REI 60</b>	<b>REI 45</b>	



	functions not accessible to the public (excluding car parks)				ground construction levels according to the standardised provisions.
		<b>IV</b>	<b>EI/REI 30</b>	<b>REI 30</b>	
		<b>V</b>	<b>EI/REI 15</b>	<b>REI 30</b>	
2.	Separating the technical annexes from the rest of the construction.	<b>I</b>	<b>EI/REI 120</b>	<b>REI 120</b>	Provided with doors depending on the fire risk and/or according to common performance provisions
		<b>II</b>	<b>EI/REI 90</b>	<b>REI 90</b>	
		<b>III</b>	<b>EI/REI 60</b>	<b>REI 60</b>	
		<b>IV</b>	<b>EI/REI 30</b>	<b>REI 30</b>	
		<b>V</b>	<b>EI/REI 30</b>	<b>REI 30</b>	

**Article 3.2.5.7.** Functional and exhaust voids in the separation elements referred to in **Article 3.2.5.6** and Table 71 shall be protected with closing elements having a fire resistance of at least half that of the wall (according to criteria **EI<sub>2</sub> C3**).

**Article 3.2.5.8.** The maximum permissible journey length on escape routes in cultural buildings (excluding crowded rooms, high and very high buildings) is specified in **Table 72**.

**Table 72: Escape lengths in above-ground culture buildings with normal heights**

Reference No	Buildings for culture	Fire stability level provided	Maximum escape length		Remarks
			in two different directions	in a direction (dead-end corridor)	
			metres	metres	
1.	Community centres, theatres, auditors, conference halls, cinemas, libraries, etc.	<b>I and II</b>	<b>40</b>	<b>20</b>	In normal culture buildings falling within the category of crowded rooms, their specific performance provisions shall be complied with.
		<b>III</b>	<b>30</b>	<b>16</b>	
		<b>IV</b>	<b>15</b>	<b>10</b>	
		<b>V</b>	<b>10</b>	<b>6</b>	

**Notes:**

In buildings for culture which are not crowded rooms, high buildings or very high buildings but are equipped with fire detection, signalling and alarm installations with total coverage, automatic fire-fighting systems and smoke exhaust systems from horizontal common paths (corridors/halls) and staircases, the standardised escape lengths of users may increase by 25 %.

**Article 3.2.5.9.** Above-ground culture buildings of normal heights shall be provided with access to and intervention of extinguishing vehicles in the event of fire, at least on one side and at least on 25 % from the perimeter of the external walls.

(2) In accordance with the maximum simultaneous capacity of the building for culture, account must also be taken of the provisions of **Article 2.6.7**, paragraphs 1, 2 and 3. For a maximum simultaneous capacity greater than 3500 persons, **Article 2.6.7**, paragraph 3 shall not be taken into account.

### 3.2.6. Above-ground education buildings

**Article 3.2.6.1.** Above-ground education buildings with ordinary heights (pre-school, primary, secondary, non-university and tertiary education, after school, accommodation areas for pupils and students, interns, school canteens, sports halls linked to the function of education, etc.) shall be designed, carried out and used according to the provisions of the Rule and applicable technical regulations, ensuring that the conditions, performance and standard performance levels differentiated according to the age of users and functional learning programmes are met.

**Article 3.2.6.2.** Above-ground education buildings of ordinary heights shall be located independently, at safe distances from neighbouring buildings or partitioned from them through fire

bulkheads. It is recommended to increase the standard safety distances by at least **50 %** and, when attached to other buildings, it shall be subdivided according to the density of the heat load ( $q$ ) in adjacent spaces, according to the provisions of the legislation and those specified in **Article 2.3.1.2.** and **Table 5** but with fire walls minimum **EI-M 180/REI 180** and minimum floors **REI 60**.

**Article 3.2.6.3. (1)** Rooms of medium or high fire risk (laboratories, warehouses, workshops, etc.) in above-ground educational buildings of normal heights shall be arranged as far as possible, isolated from classrooms or separated by fire-resistant building elements, constructed and constructed according to the density of the heat load ( $q$ ) and the fire risk in adjacent spaces.

**(2)** While ensuring specific functionality, measures shall be taken to limit potential sources of fire outbreaks and reduce combustible materials and substances in spaces and areas accessible to users.

**Article 3.2.6.4. (1)** Auxiliary rooms and associated attachments (thermal power stations, technical stations, fuel homes, generating sets, etc.) shall be provided independently, or when combined with the teaching building, shall be separated by fire resistant walls and floors according to the provisions of the Rule. Where these are not expressly specified, the provisions of **Article 2.3.1.2.** and **Table 5** and specific technical regulations shall apply. Auxiliary spaces and attachments shall have separate access routes from those associated with the learning construction.

**(2)** The location of power stations and heat points in, below or above educational rooms shall not be permitted.

**(3)** In auxiliary spaces and attachments, specific fire safety rules and measures, established according to their destination and fire risk, shall be complied with.

**(4)** It shall be prohibited to use or store liquids or combustible gases in places other than those specially designed and in specified quantities, and without complying with fire protection measures specific to them.

**Article 3.2.6.5. (1)** Above ground education buildings with normal heights shall be made of fire-resistant construction materials and elements, complying with the conditions for correlation between the destination, the level of fire stability provided, the built area ( $A_c$ ) and the number of levels, as provided for in **Article 3.1.2.6.**, **Article 3.1.2.7.** and Table 41 and Table 42.

**(2)** Finishes, treatments and thermal and sound-insulation in spaces accessible to users shall have the minimum reaction to fire class **C-s1, d0**.

**(3)** Limiting the spread of smoke in spaces, rooms, corridors and escape stairways shall be ensured by providing vertical and horizontal partitions (walls) **EI** or **REI** where applicable, floors **REI**), composed and sized according to the provisions of the Rule and specific technical regulations, with appropriate protection of functional and exhaust voids.

**(4)** Only building elements, materials, finishes, joinery panels, heat and noise treatments and insulations may be used in pre-school premises accessible to children, primary and secondary schools. **A1, A2-s1, d0** or **B-s1, d0**, excluding joinery panels (doors, windows) of metal or of wood with glass glazing.

**(5)** By way of exception to the provisions of **paragraph 4**, in education buildings, the use of combustible finishes in walls minimum **B-s2d0** is permitted, bonded to non-combustible surface, i.e. floor coverings minimum **B<sub>f</sub>-s1**, bonded to the non-combustible surface, including exhaust routes.

**Article 3.2.6.6.** The reaction to fire of walls, doors and floors separating enclosed staircases in secondary, tertiary, non-university and university buildings of ordinary heights shall correspond to the provisions of Table 73.

**Table 73: The reaction to fire of walls, doors and floors separating enclosed staircases in primary, secondary, tertiary, non-tertiary, non-university and university buildings with regular heights**

Fire stability level	Permitted reaction to fire levels in closed stairways				
	Walls		Floors (separating the staircases from the rest of the construction)		Doors
<b>I</b> <i>h</i> ≥ 28m	<b>EI/REI 180</b>	<b>A1 or A2-s1d0</b>	<b>REI 120</b>	<b>A1 or A2-s1d0</b>	<b>E 60 – C5 S<sub>200</sub></b>
<b>II</b>	<b>EI/REI 180</b>	<b>A1 or A2-s1d0</b>	<b>REI 120</b>	<b>A1 or A2-s1d0</b>	<b>E 45 – C5 S<sub>200</sub></b>
<b>II (+)</b>	<b>EI/REI 120</b>	<b>A1 or A2-s1d0</b>	<b>REI 90</b>	<b>A1 or A2-s1d0</b>	<b>E 45 – C5 S<sub>200</sub></b>
<b>III</b>	<b>EI/REI 90</b>	<b>A1 or A2-s1d0</b>	<b>REI 60</b>	<b>A1 or A2-s1d0</b>	<b>E 30 – C5 Sa</b>
<b>III (+)</b>	<b>EI/REI 60</b>	<b>A1 sau A2-s1d0</b>	<b>REI 45</b>	<b>A1 or A2-s1d0</b>	<b>E 30 – C5 Sa</b>
<b>IV</b>	<b>EI/REI 45</b>	<b>A1**, A2**-s1d0 or B-s1d0</b>	<b>REI 30</b>	<b>A1**, A2**-s1d0 or B-s1d0</b>	<b>E 15 – C5 Sa</b>
<b>V</b>	<b>EI/REI 30</b>	<b>A1, A2-s1d0, B-s1d0</b>	<b>REI 15</b>	<b>A1, A2-s1d0, B-s1d0</b>	<b>C5</b>

Notes:

(+) Construction works equipped with automatic sprinkler/spray fire-extinguishing systems in addition to the requirements of the specific technical regulations.

'h' = elevation of the last accessible/usable floor of the construction from the reference level

**Article 3.2.6.7.** The reaction to fire of walls, doors and floors separating enclosed staircases in above-ground pre-school buildings of normal heights shall comply with the provisions of Table 74.

**Table 74: The reaction to fire of walls, doors and floors separating enclosed staircases in above-ground pre-school buildings of normal heights**

Fire stability level	Permitted reaction to fire levels in closed stairways				
	Walls		Floors (separating the staircases from the rest of the construction)		Doors
<b>I</b> <i>h</i> ≥ 28m	<b>EI/REI 180</b>	<b>A1 or A2-s1d0</b>	<b>REI 120</b>	<b>A1 or A2-s1d0</b>	<b>E 60 – C5 S<sub>200</sub></b>
<b>II</b>	<b>EI/REI 180</b>	<b>A1 or A2-s1d0</b>	<b>REI 120</b>	<b>A1 or A2-s1d0</b>	<b>E 45 – C5 S<sub>200</sub></b>
<b>II (+)</b>	<b>EI/REI 120</b>	<b>A1 or A2-s1d0</b>	<b>REI 90</b>	<b>A1 or A2-s1d0</b>	<b>E 45 – C5 S<sub>200</sub></b>
<b>III</b>	<b>EI/REI 90</b>	<b>A1 or A2-s1d0</b>	<b>REI 60</b>	<b>A1 or A2-s1d0</b>	<b>E 30 – C5 Sa</b>
<b>III (+)</b>	<b>EI/REI 60</b>	<b>A1 or A2-s1d0</b>	<b>REI 45</b>	<b>A1 or A2-s1d0</b>	<b>E 30 – C5 Sa</b>
<b>IV</b>	<b>EI/REI 45</b>	<b>A1 A2-s1d0</b>	<b>REI 30</b>	<b>A1 A2-s1d0</b>	<b>E 15 - C5 Sa</b>
<b>V</b>	<b>Not permitted</b>	<b>Not permitted</b>	<b>Not permitted</b>	<b>Not permitted</b>	<b>Not permitted</b>

Notes:

(+) Construction works equipped with automatic sprinkler/spray fire-extinguishing systems in addition to the requirements of the specific technical regulations.

'h' = elevation of the last accessible/usable floor of the construction from the reference level

**Article 3.2.6.8.** The reaction to fire of walls, doors and floors separating horizontal escape routes (corridors and halls) in primary, secondary, tertiary, non-tertiary, non-university and university buildings of ordinary heights shall comply with the provisions of Table 75.

**Table 75: The reaction to fire of walls, doors and floors separating horizontal escape routes (corridors and halls) in primary, secondary, tertiary, non-tertiary, non-university and university buildings with regular heights**

Fire stability level	Permitted reaction to fire levels in corridors and halls				
	Walls		Floors (separating corridors and halls from the rest of the construction, including their exit paths to the land level or adjacent roads)	Doors (except those to closed staircases)	
<b>I</b> <i>h</i> ≥ 28m	<b>EI/REI 90</b>	<b>A1 or A2-s1d0</b>	<b>In accordance with Table 2, point 3</b> The minimum fire resistance requirements to be met by the floors ( <b>REI</b> ) for compliance with the established fire stability level.	<b>A1 or A2-s1d0</b>	<b>E 30 – C5 S<sub>200</sub></b>
<b>II</b>	<b>EI/REI 90</b>	<b>A1 or A2-s1d0</b>		<b>A1 or A2-s1d0</b>	<b>E15 – C5 S<sub>a</sub> or full doors of wood or metal</b>
<b>II (+)</b>	<b>EI/REI 90</b>	<b>A1 or A2-s1d0</b>		<b>A1 or A2-s1d0</b>	<b>E15 – C5 S<sub>a</sub> or full doors of wood or metal</b>
<b>III</b>	<b>EI/REI 60</b>	<b>A1 or A2-s1d0</b>		<b>A1 or A2-s1d0</b>	<b>C5</b>
<b>III (+)</b>	<b>EI/REI 45</b>	<b>A1 A2-s1d0</b>		<b>A1 or A2-s1d0</b>	<b>C5</b>
<b>IV</b>	<b>EI/REI 30</b>	<b>A1 A2-s1d0, B-s1d0</b>		<b>A1 A2-s1d0, B-s1d0</b>	<b>C5</b>
<b>V</b>	<b>EI/REI 15</b>	<b>A1**, A2**—s1d0 B-s1d0</b>		<b>A1**, A2**—s1d0 B-s1d0</b>	<b>-</b>

Notes:

‘-’ = no fire determined performance

In the case of glazed metal walls separating corridors and halls from adjacent rooms, the reaction to fire class shall not be taken into account.

(+) Construction works equipped with automatic sprinkler/spray fire-extinguishing systems in addition to the requirements of the specific technical regulations.

‘h’ = elevation of the last accessible/usable floor of the construction from the reference level

**Article 3.2.6.9.** The reaction to fire of walls, doors and floors separating horizontal escape routes (corridors and halls) in above-ground pre-school education buildings of normal heights shall comply with the provisions of Table 76.

**Table 76: The reaction to fire of walls, doors and floors separating horizontal escape routes (corridors and halls) in above-ground pre-school buildings with normal heights**

Fire stability level	Permitted reaction to fire levels in corridors and halls				
	Walls		Floors (separating corridors and halls from the rest of the construction, including their exit paths to the land level or adjacent roads)	Doors (except those to closed staircases)	
<b>I</b> <i>h</i> ≥ 28m	<b>EI/REI 90</b>	<b>A1 or A2-s1d0</b>	<b>In accordance with Table 2, point 3</b> The minimum fire resistance requirements to be met by the floors ( <b>REI</b> ) for compliance with	<b>A1 or A2-s1d0</b>	<b>E 30 – C5 S<sub>200</sub></b>
<b>II</b>	<b>EI/REI 90</b>	<b>A1 or A2-s1d0</b>		<b>A1 or A2-s1d0</b>	<b>E 15 – C5 S<sub>a</sub> or full doors of wood or metal</b>
<b>II (+)</b>	<b>EI/REI 90</b>	<b>A1 or A2-s1d0</b>		<b>A1 or A2-s1d0</b>	<b>E 15 – C5 S<sub>a</sub> or full doors of wood or metal</b>
<b>III</b>	<b>EI/REI 60</b>	<b>A1 or A2-s1d0</b>		<b>A1 or A2-s1d0</b>	<b>C5</b>

Fire stability level	Permitted reaction to fire levels in corridors and halls				
	Walls		Floors (separating corridors and halls from the rest of the construction, including their exit paths to the land level or adjacent roads)	Doors (except those to closed staircases)	
			the established fire stability level.		
III (+)	EI/REI 45	A1 A2-s1d0		A1 or A2-s1d0	C5
IV	EI/REI 30	A1 A2-s1d0		A1 A2-s1d0	C5
V	EI/REI 15	A1 A2-s1d0		A1 A2-s1d0	-

**Notes:**

'-' = no fire determined performance

(+) Construction works equipped with automatic sprinkler/spray fire-extinguishing systems in addition to the requirements of the specific technical regulations.

'h' = elevation of the last accessible/usable floor of the construction from the reference level

**Article 3.2.6.10. (1)** Above-ground educational buildings of normal heights shall have at least two separate and independent escape routes so arranged and constructed that they can be easily accessible to all users.

**(2)** Multilevel buildings shall have enclosed escape staircases, regardless of the number of overground or underground levels.

**(3)** The composition and dimensioning of the escape routes shall correspond to the number of users, but regardless of the escape widths (flows) resulting from the calculation, the doors arranged on the users' escape routes shall have the minimum width of free passage of **90 cm** and stairway ramps and corridors at least **1.20 m** width.

**(4)** Specialised education buildings for disabled/disabled users, must be at the level of **I** or **II** of fire stability and having a maximum of **3** above-ground levels, with the protective measures provided for in the specific regulations being ensured.

**(5)** Multipurpose rooms with a maximum simultaneous capacity greater than **100** users of pre-primary education buildings shall have at least one direct access from the outside (outdoor door on the ground or access to an external escape staircase).

**(6)** On the common horizontal escape routes (corridors, halls) it is permissible to provide for fixed furniture elements under the conditions laid down in **Article 2.5.2.1 paragraphs 5 and 6**.

**(7)** No furniture objects (fuel or non-combustible) may be placed in the escape stairway enclosure, protected escape, buffer rooms, escape tunnels, etc. in educational buildings.

**Article 3.2.6.11.** The maximum permissible journey length on escape routes in educational buildings (excluding crowded rooms, high and very high buildings) is specified in **Table 77**.

**Table 77: Escape lengths in buildings for education above normal heights**

Reference No	Buildings for education	Fire stability level provided	Maximum escape length		Remarks
			in two different directions	in a direction (dead-end corridor)	
			metres	metres	
1.	Preschool, primary, secondary, tertiary education, non-university, internships (school	<b>I and II</b>	<b>30</b> <b>(20)</b>	<b>20</b>	The values in brackets are valid for the escape of children of pre-school age
		<b>III</b>	<b>25</b> <b>(15)</b>	<b>15</b>	
		<b>IV</b>	<b>12</b>	<b>10</b>	
		<b>V</b>	<b>10</b>	<b>8</b>	

	accommodation areas)				
2.	Higher education, student dormitories.	<b>I</b>	<b>50</b>	<b>25</b>	-
		<b>II</b>	<b>40</b>	<b>20</b>	
		<b>III</b>	<b>30</b>	<b>15</b>	
		<b>IV</b>	<b>20</b>	<b>12</b>	
		<b>V</b>	<b>15</b>	<b>10</b>	

**Article 3.2.6.12. (1)** Above-ground educational constructions of normal heights shall be provided with access to and intervention of fire-fighting vehicles, at least on one side and at least on 25 % from the perimeter of the external walls, when the maximum capacity at the same time is less than 200 users, and if greater or equal to 200 users access and intervention of fire service vehicles on two sides shall be provided by users in such a way as to ensure access to and intervention of fire-fighting vehicles, at least in full on two sides (2) adjacent sides and at least on 50 % of the perimeter of the outer walls.

(2) In accordance with the maximum simultaneous capacity of the building for education, account must also be taken of the provisions of **Article 2.6.7.** paragraph 1, 2 and 3.

### 3.2.7. Above-ground buildings for tourism

**Article 3.2.7.1.** Overland tourism buildings of ordinary heights (hotels, hostels, motels, villas, bungalows, alpine lodges, boarding houses, etc.) shall comply in such a way as to meet the conditions for correlation between the destination, the level of fire stability provided, the built area (Ac) and the number of levels, as provided for in **Article 3.1.2.6.**, **Article 3.1.2.7.** and Table 41 and Table 42.

**Article 3.2.7.2.** The reaction to fire of walls, doors and separation floors of enclosed staircases in above ground buildings for tourism of normal heights shall comply with the provisions of Table 78.

**Table 78: The reaction to fire of walls, doors and floors separating enclosed staircases in above ground buildings of ordinary heights for tourism**

Fire stability level	Permitted reaction to fire levels in closed stairways				
	Walls		Floors (separating the staircases from the rest of the construction)		Doors
<b>I</b> <i>h</i> ≥ 28m	<b>EI/REI 180</b>	<b>A1 or A2-s1d0</b>	<b>REI 120</b>	<b>A1 or A2-s1d0</b>	<b>E 60 - C5 S<sub>200</sub></b>
<b>II</b>	<b>EI/REI 180</b>	<b>A1 or A2-s1d0</b>	<b>REI 120</b>	<b>A1 or A2-s1d0</b>	<b>E 45 - C5 S<sub>200</sub></b>
<b>II (+)</b>	<b>EI/REI 120</b>	<b>A1 or A2-s1d0</b>	<b>REI 90</b>	<b>A1 or A2-s1d0</b>	<b>E 45 - C5 S<sub>200</sub></b>
<b>III</b>	<b>EI/REI 90</b>	<b>A1 or A2-s1d0</b>	<b>REI 60</b>	<b>A1 or A2-s1d0</b>	<b>E 30 - C5 Sa</b>
<b>III (+)</b>	<b>EI/REI 60</b>	<b>A1 or A2-s1d0</b>	<b>REI 45</b>	<b>A1 or A2-s1d0</b>	<b>E 30 - C5 Sa</b>
<b>IV</b>	<b>EI/REI 45</b>	<b>A1, A2-s1d0 or B-s1d0</b>	<b>REI 30</b>	<b>A1, A2-s1d0 or B-s1d0</b>	<b>E 15 - C5 Sa</b>
<b>V</b>	<b>EI/REI 30</b>	<b>A1, A2-s1d0, B-s1d0, C-s1d0</b>	<b>REI 15</b>	<b>A1, A2-s1d0, B-s1d0, C-s1d0</b>	<b>C5</b>

Notes:

(+) Construction works equipped with automatic sprinkler/spray fire-extinguishing systems in addition to the requirements of the specific technical regulations.

'h' = elevation of the last accessible/usable floor of the construction from the reference level

**Article 3.2.7.3.** The reaction to fire of walls, doors and floors separating horizontal escape routes (corridors and halls) in above-ground buildings of normal heights for tourism shall comply with the provisions of Table 79.

**Table 79: The reaction to fire of walls, doors and floors separating horizontal escape routes (corridors and halls) in above-ground buildings with normal heights for tourism**

Fire stability level	Permitted reaction to fire levels in corridors and halls				
	Walls		Floors (separating corridors and halls from the rest of the construction, including their exit paths to the land level or adjacent roads)	Doors (except those to closed staircases)	
<b>I</b> <i>h</i> ≥ 28m	<b>EI/REI 90</b>	<b>A1 or A2-s1d0</b>	<b>In accordance with Table 2, point 3</b> The minimum fire resistance requirements to be met by the floors (REI) for compliance with the established fire stability level.	<b>A1 or A2-s1d0</b>	<b>E 30 - C5 S<sub>a</sub></b>
<b>II</b>	<b>EI/REI 90</b>	<b>A1 or A2-s1d0</b>		<b>A1 or A2-s1d0</b>	<b>E15 - C5 S<sub>a</sub> or full doors of wood or metal</b>
<b>II (+)</b>	<b>EI/REI 90</b>	<b>A1 sau A2-s1d0</b>		<b>A1 sau A2-s1d0</b>	<b>E15 - C5 S<sub>a</sub> or full doors of wood or metal</b>
<b>III</b>	<b>EI/REI 60</b>	<b>A1 or A2-s1d0</b>		<b>A1 or A2-s1d0</b>	<b>C5</b>
<b>III (+)</b>	<b>EI/REI 45</b>	<b>A1, A2-s1d0</b>		<b>A1 sau A2-s1d0</b>	<b>C5</b>
<b>IV</b>	<b>EI/REI 45</b>	<b>A1, A2-s1d0 or B-s1d0</b>		<b>A1, A2-s1d0 or B-s1d0</b>	<b>C5</b>
<b>V</b>	<b>EI/REI 30</b>	<b>A1, A2-s1d0, B-s1d0, C-s1d0</b>		<b>A1, A2-s1d0, B-s1d0, C-s1d0</b>	<b>-</b>

Notes:

In the case of glazed metal walls separating corridors and halls from adjacent rooms, the reaction to fire class shall not be taken into account.

(+) Construction works equipped with automatic sprinkler/spray fire-extinguishing systems in addition to the requirements of the specific technical regulations.

'h' = elevation of the last accessible/usable floor of the construction from the reference level

**Article 3.2.7.4.** Monumental stairways may be opened to the full height of the construction for above ground of normal height for tourism, provided that enclosures are also provided to ensure that the standard conditions for the escape of users are met.

**Article 3.2.7.5.** The maximum permissible journey length on escape routes in tourist buildings (with the exception of crowded rooms, high and very high buildings) are specified in Table 80.

**Table 80: Escape lengths in buildings for above ground tourism with ordinary heights**

Reference No	Buildings for tourism	Fire stability level provided	Maximum escape length		Remarks
			in two different directions	in a direction (dead-end corridor)	
			metres	metres	
1.	Hotels, motels, booths, boarding houses, etc.	<b>I and II</b>	<b>40</b>	<b>20</b>	-
		<b>III</b>	<b>30</b>	<b>16</b>	
		<b>IV</b>	<b>15</b>	<b>10</b>	
		<b>V</b>	<b>10</b>	<b>6</b>	

Note:

*In non-crowded tourist buildings, tall buildings or very high buildings but equipped with fire detection, signalling and alarm installations with total coverage, automatic fire-fighting systems and smoke exhaust systems in horizontal common paths (corridors/hall) and staircases, standardised user escape lengths may increase by 25 %.*

**Article 3.2.7.6.** In cases where buildings for overground tourism of ordinary height also have underground levels where Annex functions are arranged (central, workshops, car parks, etc.), these shall be separated from the above-ground levels by fire resistant floors **REI 120**.

**Article 3.2.7.7.** In above ground tourism constructions of normal height with a total accommodation capacity greater than **50**, minimum two escape routes for users shall be provided.

**Article 3.2.7.8. (1)** Above ground constructions of normal height for tourism, with a total accommodation capacity greater than **50** accommodation places, access to and intervention of fire extinguishing vehicles shall be provided, at least in full on two **(2)** adjacent sides and at least on **50 %** from the perimeter of the external walls, and those with smaller capacities of **50** accommodation places shall be provided with access to and intervention of extinguishing vehicles in the event of fire, at least on one side and at least to **25 %** from the perimeter of the external walls.

**(2)** In accordance with the maximum capacity of the tourist building at the same time, account must also be taken of the provisions of **Article 2.6.7.** paragraphs **1, 2** and **3**.

### **3.2.8. Above-ground worship buildings**

**Article 3.2.8.1.** Above-ground worship buildings of normal height (cathedrals, churches, places of worship, synagogues, temple, prayer houses, etc.) and monastery assemblies except for sleeping areas and those attached thereto, shall meet the fire stability requirements laid down in **Article 2.1.3.2** and Table 2 of the Rule, and ground floor buildings with the maximum simultaneous capacity of **100** users the minimum reaction to fire class can be made of wooden building elements **D-s1d0** or **D-s2d0**.

**Article 3.2.8.2. (1)** Above-ground buildings of normal height shall conform so as to meet the conditions for correlation between the destination, the level of fire stability provided, the built area (Ac) and the number of levels as specified in **Article 3.1.2.6.**, **Article 3.1.2.7.** and Table 41 and Table 42.

**(2)** Overlying buildings of normal height shall be sited independently of, or partitioned from, the normal safety distances of neighbouring buildings with components of construction intended to separate fire compartments (fire bulkheads).

**Article 3.2.8.3.** For worship buildings falling within the category of crowded rooms, the specific performance provisions will also be complied with.

**Article 3.2.8.4. (1)** Above-ground worn buildings of normal height having a simultaneous capacity of more than **100** at least two separate and independent escape routes shall be provided by users.

**(2)** Worship buildings capable of **30** by users and beyond, they shall have escape doors with normal opening on hinges or pivots and opening in the direction of escape of users outwards.

**(3)** Intermediate floors, mezzanines and balconies not exceeding **70** persons may have escape of users through an open internal staircase.

**(4)** Basement buildings shall have separate access to the bedrock and, where the basement includes functional spaces necessary for culture, functional circulation and escape gaps may be made between the subsurface and the ground floor, provided that they are protected by fire resistant doors as a minimum **EI<sub>2</sub> 30-C5 S<sub>200</sub>**.



**Article 3.2.8.5.** The maximum permissible escape length of the route on escape routes in worship buildings (except for crowded rooms, high and very high buildings) is specified in **Table 81**.

**Table 81: Escape lengths in worship buildings of normal heights**

Reference No	Worship buildings	Fire stability level provided	Maximum escape length		Remarks
			in two different directions	in a direction (dead-end corridor)	
			metres	metres	
1.	Cathedrals, churches, mosques, prayers, pagodas, temples, etc.	<b>I and II</b>	<b>50</b>	<b>25</b>	For ordinary worship buildings falling within the category of crowded rooms, their specific performance provisions shall be complied with.
		<b>III</b>	<b>30</b>	<b>15</b>	
		<b>IV</b>	<b>25</b>	<b>12</b>	
		<b>V</b>	<b>15</b>	<b>10</b>	

Note:

In worship buildings which are not crowded rooms, high buildings or very high buildings, but are equipped with fire detection, signalling and alarm installations with total coverage, automatic fire extinguishing and smoke exhaust systems, the standardised escape lengths of users may be increased by 25 %.

**Article 3.2.8.6.** Open fire (candles, candelas, etc.) in any building of worship may be used with the provision of specific fire defence measures and in places properly established and equipped.

**Article 3.2.8.7.** Utility installations relating to above-ground worn buildings with normal heights (sanitary, electrical, heating, ventilation, etc.) shall be designed and carried out according to the provisions of the specialised technical regulations.

**Article 3.2.8.8.** Above-ground buildings of normal heights shall be provided with access to and intervention of extinguishing vehicles in the event of fire, at least on one side and at least on 25 % within the perimeter of the external walls, with the exception of those provided for with agglomerated salads or forming part of a high or very high building, respecting the specific provisions.

(2) In accordance with the maximum concurrent capacity of the building of worship, account must also be taken of the provisions of **Article 2.6.7.** paragraphs 1, 2 and 3.

### **3.2.9. Above-ground sports buildings**

**Article 3.2.9.1. (1)** Above-ground sport buildings of normal heights shall conform so as to meet the requirements for correlation between the destination, the fire stability level provided, the area built up (**Ac**) and number of tiers, as provided for **Article 3.1.2.6.**, **Article 3.1.2.7.** and Table 41 and Table 42.

(2) For sports buildings falling under the category of crowded rooms, high or very high buildings, the specific performance provisions shall also be complied with.

**Article 3.2.9.2.** Where overground sports buildings of ordinary heights also have underground levels where Annex functions are arranged, they shall be separated from the above-ground levels by fire resistant floors as a minimum **REI 120**. Basements and semibasements with functions similar to those arranged at above-ground levels are excluded.

**Article 3.2.9.3.** The burning behaviour of walls, doors and separation floors of enclosed staircases in above-ground sports buildings of normal heights shall comply with the requirements of Table 82.

**Table 82: Fire behaviour of walls, doors and separation floors of enclosed staircases in above-ground sports buildings of ordinary heights**

Fire stability level	Permitted reaction to fire levels in closed stairways				
	Walls		Floors (separating the staircases from the rest of the construction)		Doors
<b>I</b> <i>h</i> ≥ 28m	<b>EI/REI 180</b>	<b>A1 or A2-s1d0</b>	<b>REI 120</b>	<b>A1 or A2-s1d0</b>	<b>E 60 - C5 S<sub>200</sub></b>
<b>II</b>	<b>EI/REI 180</b>	<b>A1 or A2-s1d0</b>	<b>REI 120</b>	<b>A1 or A2-s1d0</b>	<b>E 45 - C5 S<sub>200</sub></b>
<b>II (+)</b>	<b>EI/REI 120</b>	<b>A1 or A2-s1d0</b>	<b>REI 90</b>	<b>A1 or A2-s1d0</b>	<b>E 45 - C5 S<sub>200</sub></b>
<b>III</b>	<b>EI/REI 90</b>	<b>A1 or A2-s1d0</b>	<b>REI 60</b>	<b>A1 or A2-s1d0</b>	<b>E 30 - C5 S<sub>a</sub></b>
<b>III (+)</b>	<b>EI/REI 60</b>	<b>A1 or A2-s1d0</b>	<b>REI 45</b>	<b>A1 or A2-s1d0</b>	<b>E 30 - C5 S<sub>a</sub></b>
<b>IV</b>	<b>EI/REI 45</b>	<b>A1, A2-s1d0 or B-s1d0</b>	<b>REI 30</b>	<b>A1, A2-s1d0 or B-s1d0</b>	<b>E 15 - C5 S<sub>a</sub></b>
<b>V</b>	<b>EI/REI 30</b>	<b>A1, A2-s1d0, B-s1d0, C-s1d0</b>	<b>REI 15</b>	<b>A1, A2-s1d0, B-s1d0, C-s1d0</b>	<b>C5</b>

Notes:

(+) Construction works equipped with automatic sprinkler/spray fire-extinguishing systems in addition to the requirements of the specific technical regulations.

'h' = elevation of the last accessible/usable floor of the construction from the reference level

**Article 3.2.9.4.** The fire behaviour of the horizontal escape walls, doors and floors (corridors and hall) in overground sports buildings of normal heights shall correspond to the provisions of Table 83.

**Table 83: The reaction to fire of walls, doors and floors separating horizontal escape routes (corridors and halls) in sport buildings of ordinary heights**

Fire stability level	Permitted reaction to fire levels in corridors and halls				
	Walls		Floors (separating corridors and halls from the rest of the construction, including their exit paths to the land level or adjacent roads)		Doors (except those to closed staircases)
<b>I</b> <i>h</i> ≥ 28m	<b>EI/REI 90</b>	<b>A1 or A2-s1d0</b>	<b>In accordance with Table 2, point 3</b> The minimum fire resistance requirements to be met by the floors (REI) for compliance with the established fire stability level.	<b>A1 or A2-s1d0</b>	<b>E 30 – C5 S<sub>200</sub></b>
<b>II</b>	<b>EI/REI 60</b>	<b>A1 or A2-s1d0</b>		<b>A1 or A2-s1d0</b>	<b>E15 – C5 S<sub>a</sub> or full doors of wood or metal</b>
<b>II (+)</b>	<b>EI/REI 60</b>	<b>A1 or A2-s1d0</b>		<b>A1 or A2-s1d0</b>	<b>E15 – C5 S<sub>a</sub> or full doors of wood or metal</b>
<b>III</b>	<b>EI/REI 45</b>	<b>A1 or A2-s1d0</b>		<b>A1 or A2-s1d0</b>	<b>C5</b>
<b>III (+)</b>	<b>EI/REI 45</b>	<b>A1 or A2-s1d0</b>		<b>A1 or A2-s1d0,</b>	<b>C5</b>
<b>IV</b>	<b>EI/REI 30</b>	<b>A1, A2-s1d0, B-s1d0</b>		<b>A1, A2-s1d0, B-s1d0</b>	<b>C5</b>

Fire stability level	Permitted reaction to fire levels in corridors and halls				
	Walls		Floors (separating corridors and halls from the rest of the construction, including their exit paths to the land level or adjacent roads)	Doors (except those to closed staircases)	
V	EI/REI 15	A1, A2-s1d0, B-s1d0, C-s1d0		A1, A2-s1d0, B-s1d0, C-s1d0	-

Notes:

‘-’ = no fire determined performance

In the case of glazed metal walls separating corridors and halls from adjacent rooms, the reaction to fire class shall not be taken into account.

(+) Construction works equipped with automatic sprinkler/spray fire-extinguishing systems in addition to the requirements of the specific technical regulations.

‘h’ = elevation of the last accessible/usable floor of the construction from the reference level

**Article 3.2.9.5. (1)** Above-ground closed sports buildings with regular heights and greater capacity of **100** users, a minimum of two escape routes shall be provided.

**(2)** The seats shall be solidarized by the platform or graduation on which they are arranged or on seat packages. Benches, seats, etc. must not exceed the criteria established for the assessment of ignition of upholstered furniture.

**(3)** The distance of free movement between rows of seats shall be at least **35 cm**.

**(4)** Guidance signs and safety lighting shall be provided on the escape routes of users, according to the provisions of the relevant technical regulations.

**Article 3.2.9.6.** *The maximum permissible escape length of the journey through escape routes in sport buildings (excluding crowded rooms, high and very high buildings) is specified in Table 84.*

**Table 84: Escape lengths in closed overground sports buildings with ordinary heights**

Reference No	Sports buildings	Fire stability level provided	Maximum escape length		Remarks
			in two different directions	in a direction (dead-end corridor)	
			metres	metres	
1.	Ordinary closed buildings for sport	<b>I and II</b>	<b>100</b>	<b>50</b>	For ordinary sports buildings falling within the category of crowded rooms, their specific performance provisions shall be complied with.
		<b>III</b>	<b>75</b>	<b>30</b>	
		<b>IV</b>	<b>50</b>	<b>25</b>	
		<b>V</b>	<b>25</b>	<b>15</b>	

Note:

In buildings which are not crowded rooms, high buildings or very high buildings but are equipped with full-cover fire-detection, signalling and alarm installations, automatic fire-fighting systems and smoke escape systems, standardised user escape lengths from common horizontal paths, hops and corridors, and staircases may increase by 25 %.

**Article 3.2.9.7.** Above-ground sports buildings of normal heights shall have access to and intervention of fire extinguishing vehicles, at least in full on two **(2)** adjacent sides and at least on **50 %** of the perimeter of the external walls

**(2)** In accordance with the maximum concurrent capacity of the sport building, account must also be taken of the provisions of **Article 2.6.7.** paragraphs **(1)**, **(2)** and **(3)**.

### 3.2.10. Above-ground, mountainous or Danube Delta civil buildings, remotely located

**Article 3.2.10.1.** Above-ground civil constructions with ordinary mountainous or Danube Delta heights, located in isolation, outside the built-up areas of the localities (cabs, refuges, hotels, motels, boarding houses, sanatoria, etc.) shall comply in such a way as to meet the conditions for correlation between the destination, the level of fire stability provided, the area built up (**Ac**) and number of levels, as set out in **Article 3.1.2.6.**, Table 41 **Article** and 3.1.2.7. and Table 42 .

**Article 3.2.10.2.** In isolated above-ground civil buildings with normal mountainous or Danube Delta heights, it shall be ensured that the light propagation of fires is limited to and from the surroundings of the enclosure by respecting normal safety distances and distances of at least **5 times** the height of the highest building relative to the neighbourhoods (buildings, installations, woodland, reed, etc.) outside the enclosure.

**Article 3.2.10.3. (1)** The technical areas annexed to mountain or Danube Delta buildings, located in isolation (thermal power plants, generating sets, pumping stations, etc., including storage of materials or combustible substances), should be located independently.

**(2)** The enclosed technical areas of mountain or Danube Delta buildings, located in isolation, shall be separated according to the density of the thermal load (**q**), according to the provisions of **Article 2.3.1.2** and **Table 5** but with walls or more **EI/REI 120** and, where applicable, with a minimum floor **REI 90**.

**Article 3.2.10.4.** The reaction to fire of walls, doors and floors separating enclosed staircases in isolated above-ground civil buildings shall comply with the provisions of Table 85.

**Table 85: The reaction to fire of walls, doors and floors separating enclosed staircases in ordinary mountainous civil buildings or in the Danube Delta, isolated**

Fire stability level	Permitted reaction to fire levels in closed stairways				
	Walls		Floors (separating the staircases from the rest of the construction)		Doors
<b>I</b> <i>h</i> ≥ 28m	<b>EI/REI 180</b>	<b>A1 or A2-s1d0</b>	<b>REI 120</b>	<b>A1 or A2-s1d0</b>	<b>E 60 - C5 S<sub>200</sub></b>
<b>II</b>	<b>EI/REI 180</b>	<b>A1 or A2-s1d0</b>	<b>REI 120</b>	<b>A1 or A2-s1d0</b>	<b>E 45 - C5 S<sub>200</sub></b>
<b>II (+)</b>	<b>EI/REI 120</b>	<b>A1 or A2-s1d0</b>	<b>REI 90</b>	<b>A1 or A2-s1d0</b>	<b>E 45 - C5 S<sub>200</sub></b>
<b>III</b>	<b>EI/REI 90</b>	<b>A1 or A2-s1d0</b>	<b>REI 60</b>	<b>A1 or A2-s1d0</b>	<b>E 30 - C5 Sa</b>
<b>III (+)</b>	<b>EI/REI 60</b>	<b>A1 or A2-s1d0</b>	<b>REI 45</b>	<b>A1 or A2-s1d0</b>	<b>E 30 - C5 Sa</b>
<b>IV</b>	<b>EI/REI 45</b>	<b>A1, A2-s1d0 or B-s1d0</b>	<b>REI 30</b>	<b>A1, A2-s1d0 or B-s1d0</b>	<b>E 15 - C5</b>
<b>V*</b>	<b>EI/REI 15*</b>	<b>A1, A2-s1d0, B-s1d0, C-s1d0</b>	<b>REI 15*</b>	<b>A1, A2-s1d0, B-s1d0, C-s1d0</b>	<b>C5*</b>

**Note:** \* = except ordinary buildings with a single above-ground mountain level or in the Danube Delta  
 (+) Construction works equipped with automatic sprinkler/spray fire-extinguishing systems in addition to the requirements of the specific technical regulations.

‘**h**’= elevation of the last accessible/usable floor of the construction from the reference level

**Article 3.2.10.5.** The reaction to fire of walls, doors and floors separating horizontal escape routes (corridors and hops) in civil buildings of ordinary, mountainous heights or from Danube Delta, located in isolation, shall correspond to the provisions of the Table 86.

**Table 86: Fire behaviour of walls, doors and horizontal escape separation boards (corridors and halls) in ordinary mountainous civil buildings or in the Danube Delta, located in isolation**

Fire stability level	Permitted reaction to fire levels in corridors and halls				
	Walls		Floors (separating corridors and halls from the rest of the construction, including their exit paths to the land level or adjacent roads)	Doors (except those to closed staircases)	
<b>I</b> <i>h</i> ≥ 28m	<b>EI/REI 90</b>	<b>A1 or A2-s1d0</b>	<b>In accordance with Table 2, point 3</b> The minimum fire resistance requirements to be met by the floors (REI) for compliance with the established fire stability level.	<b>A1 or A2-s1d0</b>	<b>E 15 - C5 S<sub>200</sub></b>
<b>II</b>	<b>EI/REI 60</b>	<b>A1 or A2-s1d0</b>		<b>A1 or A2-s1d0</b>	<b>E 15 - C5 Sa</b>
<b>II (+)</b>	<b>EI/REI 60</b>	<b>A1 or A2-s1d0</b>		<b>A1 or A2-s1d0</b>	<b>E 15 - C5 Sa</b>
<b>III</b>	<b>EI/REI 45</b>	<b>A1 or A2-s1d0</b>		<b>A1 or A2-s1d0</b>	<b>C5</b>
<b>III (+)</b>	<b>EI/REI 45</b>	<b>A1 or A2-s1d0</b>		<b>A1 or A2-s1d0,</b>	<b>C5</b>
<b>IV</b>	<b>EI/REI 30</b>	<b>A1, A2-s1d0, B-s1d0, C-s1d0</b>		<b>A1, A2-s1d0, B-s1d0, C-s1d0</b>	<b>C5</b>
<b>V*</b>	<b>EI/REI 15*</b> (-*)	<b>A1, A2-s1d0, B-s1d0, C-s1d0, D-s1d0</b>	<b>(*)</b>	<b>A1, A2-s1d0, B-s1d0, C-s1d0, D-s1d0</b>	<b>C5*</b>

Notes:

- a) \* = except for ordinary buildings with a single above-ground mountain level or in the Danube Delta (including lake constructions) containing local materials
- (+) Construction works equipped with automatic sprinkler/spray fire-extinguishing systems in addition to the requirements of the specific technical regulations.
- 'h' = elevation of the last accessible/usable floor of the construction from the reference level
- ;
- b) In the case of glazed metal walls separating corridors and halls from adjacent rooms, the reaction to fire class shall not be taken into account.
- c) For single-level constructions made of local materials it is not necessary to establish the performance-to-fire performance of building elements.

**Article 3.2.10.6.** Buildings shall have accommodation rooms separated from other functions (restaurants, kitchens, offices, etc.), through minimum fire resistant walls. **EI/REI 60** and, where applicable, minimum fire resistant floors **REI 60**. For health resorts, the provisions specific to health buildings shall also be complied with.

**Article 3.2.10.7.** Above-ground, mountain or Danube Delta civil constructions with maximum simultaneous capacity of no more than **50** accommodation places, may have the level of **V** of fire stability and maximum **3** above-ground levels, if fitted with fire detection, signalling and alarm installation with full coverage and minimum **2** separate and independent escape routes and subject to compliance with the measures in brackets specified in Table 2: Minimum conditions for classifying the construction or fire compartment into civil buildings fire stability levels for fire stability level **V**. Protection with AFDD devices is mandatory according to the recommendations of SR EN 62606 and the specifications of the profile standard 'Standards for the design, execution and operation of electrical installations related to buildings, reference No **I7**.

**Article 3.2.10.8.** Horizontal routes for functional circulation and escape of users in the event of fire in ordinary mountain buildings or in the Danube Delta, located in isolation, with the level of fire stability **V** having at least two above-ground levels shall be separated from the rest of the construction by minimum fire resistant elements **EI/REI 15** for walls, and **REI 15** for floors and

stairways that ensure the escape of more than one level to users shall be closed in staircases separated from the rest of the building by minimum fire-resistant walls **EI/REI 15**.

**Article 3.2.10.9.** The maximum permissible escape length of the route from escape routes to civil buildings of ordinary mountainous or Danube Delta, located in isolation (excluding crowded rooms, high and very high buildings), are specified in **Table 87**.

**Table 87: Escape lengths in ordinary mountainous or Danube Delta civil buildings remotely located**

Reference No	Administrative buildings	Fire stability level provided	Maximum escape length		Remarks
			in two different directions	in a direction (dead-end corridor)	
			metres	metres	
1.	Hotels, motels, booths, boarding houses, etc., remotely located	<b>I and II</b>	<b>40</b>	<b>20</b>	-
		<b>III</b>	<b>30</b>	<b>16</b>	
		<b>IV</b>	<b>15</b>	<b>10</b>	
		<b>V</b>	<b>10</b>	<b>6</b>	

**Article 3.2.10.10.** Local heating using stoves with heat storage is permitted in buildings with normal mountainous or Danube Delta heights, which have a maximum of 3 above-ground levels, provided that local protective measures are ensured. The use of non-heat-storage stoves is not permitted.

**Article 3.2.10.11.** Above-ground constructions with typical mountainous or Danube Delta sited insulated buildings with higher capacities of **50** accommodation places shall be provided, at least on one side, for access to, and intervention by, the intervention vehicles in the event of fire and emergency craft.

### 3.2.11. Car parks

**Article 3.2.11.1. (1)** The construction of car parks may be open or closed and placed above ground or underground compared to the reference level.

**(2)** When designing and constructing higher-than-ground and underground car parks **10** passenger cars, the provisions of the Rule shall be complied with.

**(3)** Underground parks for more than **10** passenger cars shall comply with the fire safety requirements laid down in the 'Fire safety standard for underground car parks', indicative **NP 127**.

**(4)** The distance between outdoor parks on the ground (which are not built) and the façade of any above-ground building or overland exits from underground buildings must be at least **6 m**.

**(5)** The above-ground car parks fitted on terraces of some buildings in lower doors are minimum **6 m** the facade of the higher construction.

**Article 3.2.11.2.** Car parks (above-ground or underground) are considered to be civil buildings with high fire risk. The other parking areas will have the fire risks determined according to the destination and the density of the heat load (**q**), according to the provisions of the legislation.

**Article 3.2.11.3. (1)** Location of above-ground car parks for more than **10** passenger cars may be constructed independently or partitioned from constructions of a different intended use to which they are attached or are incorporated as follows:

**a)** arranged independently, at normal safety distances from neighbouring above-ground or underground constructions or installations, as provided for in Table 4;

- b)** independently arranged at standard safety distances lower than the requirements of Table 4 to neighbouring above-ground or underground constructions or installations fitted with fire bulkheads subdivision to them as a minimum **EI-M/REI 240**;
- c)** allotted to other above-ground constructions, to which fire bulkheads are subdivided **EI-M/REI 240**;
- d)** embedded in overground constructions with a different purpose, separated by minimum fire-resistant walls **EI/REI 240** and floors **REI 180** when they are high, very high buildings or with crowded rooms and with minimum fire resistant walls respectively **EI/REI 180** and floors **REI 120** when the buildings in which they are incorporated are of normal heights.

(2) Communication gaps in walls at **paragraph 1** must be provided with protected buffer rooms ventilated under excess pressure, with walls/floors **EI 120/REI 120** and fire resistant and smoke tight doors **EI<sub>2</sub> 90-C5 S<sub>200</sub>**.

(3) Communication of above-ground car parks for more than **10** passenger cars, having vertical or horizontal internal circulation, shall be provided through protected buffers ventilated under excess pressure provided with fire resistant and smoke tight doors **EI<sub>2</sub> 60-C5 S<sub>200</sub>**.

(4) By placing and complying overground car parks for more than **10** cars, access and intervention routes shall be provided for firefighting and user rescue vehicles.

(5) In above-ground car parks, the safety distances shall be increased by **50 %** to neighbouring constructions.

**Article 3.2.11.4. (1)** Above-ground car parks shall have the level of fire stability ensured in such a way as to meet the requirements for fire compliance, according to the regulatory provisions.

(2) Above-ground car parks for more than **10** passenger cars and maximum underground cars **10** cars shall correspond to the level of **I** or **II** fire stability.

(3) Above-ground car parks for more than **5** cars, but maximum **10** passenger cars must be at least the level **III** fire stability.

(4) Above-ground car parks for a maximum of **5** cars, can be at the level of **IV** or **V** fire stability.

(5) Built-up areas (**Ac**) above-ground car parks are not limited to buildings with the level of **I** fire stability. In above-ground car parks with level **II** fire stability, built-up areas (**Ac**) are limited to **7 500 m<sup>2</sup>** for constructions with more than **2** tiers, **15 000 m<sup>2</sup>** for constructions with **2** levels and not limited to the ground floor.

**Article 3.2.11.5. (1)** Enclosed above-ground parks shall be separated inside with minimum fire resistant walls **EI/REI 60** in areas not exceeding **6 000 m<sup>2</sup>** when fitted with automatic fire-fighting systems and not exceeding **3 000 m<sup>2</sup>** when not equipped with such facilities.

(2) Functional circulation and escape voids from the partitions specified in **paragraph 1**, shall be protected with closing elements that are resistant to fire and smoke tight to a minimum **EI<sub>1</sub> 60-C5S<sub>200</sub>**

(3) Irrespective of the number of separations referred to in **paragraph 1** made inside the car park under the conditions of **paragraphs 1** and **2**, they constitute a single floor.

**Article 3.2.11.6. (1)** Car parks for a maximum of **10** cars, including, are separated from the building in which they are embedded or attached, and from staircases by walls **REI 120** and floors **REI 120**.

(2) Communication of enclosed car parks for maximum **10** motor cars, including other buildings or spaces for other purposes, as well as for internal, vertical or horizontal movements, shall be provided by means of protected buffer rooms ventilated under excess pressure, with fire resistant walls as a minimum **EI/REI 120** and minimum floors **REI 120** fitted with fire resistant and smoke tight doors as a minimum **EI<sub>2</sub> 60-C5S<sub>200</sub>**.

(3) Communication of open car parks for maximum **10** motor cars (including), with other buildings or spaces for other purposes, as well as for internal, vertical or horizontal circulation, are made by fire resistant and smoke tight doors. **EI<sub>2</sub> 90-C5S<sub>200</sub>**.

(4) Above-ground car parks attached to dwelling buildings, with a maximum capacity 5 cars, separated by walls **REI 60** and minimum floors **REI 60**.

(5) Communication of above-ground car parks attached to dwelling buildings with maximum capacity 5 cars, by fire resistant and smokeproof doors **EI<sub>2</sub> 60-C5S<sub>200</sub>**.

**Article 3.2.11.7. (1)** Car parks for more than **10** cars, separate from internal escape staircases enclosed by minimum fire resistant walls **EI/REI 240** and floors **REI 180** when incorporated into high, very tall buildings or with crowded rooms and with minimum fire resistant walls respectively **EI/REI 180** and floors **REI 120** when the buildings in which they are incorporated are of normal heights.

(2) Communication of enclosed above-ground car parks for more than **10** cars and maximum underground car parks **10** motor cars with internal escape stairways enclosed are provided by buffers ventilated over pressure, with minimum fire resistant walls **EI/REI 120** fitted with fire resistant and smoke tight doors as a minimum **EI<sub>2</sub> 60-C5 S<sub>200</sub>**. In high buildings communication of above-ground car parks enclosed with escape stairways shall be carried out through buffers ventilated in excess pressure on minimum fire-resistant walls **EI/REI 180** fitted with fire resistant and smoke tight doors as a minimum **EI<sub>2</sub> 60-C5 S<sub>200</sub>**. In very high buildings as well as buildings with crowded rooms the communication of above-ground parking areas enclosed with escape stairways shall be carried out through protected buffer rooms ventilated under excess pressure, with fire resistant doors and smoke tight as a minimum **EI<sub>2</sub> 90-C5 S<sub>200</sub>**.

(3) Communication of above-ground car parks open for more than **10** cars with closed internal escape stairways are provided by buffers ventilated in excess pressure with minimum fire resistant walls **EI/REI 180** protected, fitted with fire resistant and smoke tight doors **EI<sub>2</sub> 90-C5 S<sub>200</sub>**. In high or very high buildings as well as those with crowded rooms, overground parks embedded in these buildings are not permitted. In high or very high buildings, overground parks attached to these buildings are not permitted.

**Article 3.2.11.8. (1)** The number of users at the most busy parking level shall be taken into account for the dimensioning of the flats of the staircase ramps.

(2) Doors provided on the escape routes of the users of the parks shall be of a normal type, on hinges or pivotal.

(3) Escape doors for access to vertical or horizontal escape movements (those provided at stairways, buffers ventilated under overpressure access to stairways, corridors, halls, protected openings, tunnels) shall always open in the outward escape direction.

(4) Facilities for other activities shall not be permitted in and depressed by car park users.

(5) The ramps of enclosed stairway associated with underground doors shall be separated from the ramps of stairways in which the fire resistant bulkhead car park is embedded **EL/REI 180** on parks in above-ground, very high or crowded buildings, and **EL/REI 120** car parks in above-ground buildings not covered by the previous ones. In the partition wall of underground and above-ground ramps, the functional circulation of users can be ensured by an empty on the ground floor or intermediate trellis between the ground floor and the first underground parking level, protected by fire resistant door **EL 90-C**. It is advisable to ensure that the underground section of the car park is removed directly to the outside at the level of the terrain or road surfaces, separately from the length of the above ground section of the car park.

(6) It is forbidden to prevent one or two isolated steps on escape movements to stairways or exits outdoors.

(7) Escape staircases from underground enclosures shall be provided with an independent smoke exhaust system in the event of fire.



**Article 3.2.11.9.** When establishing car parking spaces in above-ground and underground car parks for maximum **10** cars, the following shall be considered:

- a) car parking shall only be provided in the spaces designated and marked for it, without hindering the functional circulation and intervention in the event of fire;
- b) the parking of three motorcycles, scooters or ATVs shall be considered equivalent to a car parking space;
- c) compliance with the rules and specific technical regulations, considering parking as a whole, regardless of the number of compartments and levels;
- d) parking spaces located outside the above-ground car park shall not be taken into account when determining the reception capacity of the car park.

**Article 3.2.11.10. (1)** The number of accesses for cars in above-ground car parks shall be determined according to the type of car park, i.e.:

- a) Parking type **P1**: from **11** to **100** passenger cars;
- b) Parking type **P2** : between **101** and **300** passenger cars;
- c) Parking type **P3** : between **301** and **1 000** passenger cars;
- d) Parking type **P4** : over **1000** passenger cars.

**(2)** On above-ground car parks of the type **P1** or **P2** there shall be a minimum of two-wire access track and standard car parks shall be provided **P1** for a maximum of 30 passenger cars may only be fitted with an access lift (lift).

**(3)** On above-ground car parks of the type **P3** or **P4** a minimum of two accesses shall be provided, each with two wires.

**(4)** Within enclosed above-ground car parks, it is permissible to provide for the functional annexes to the car park, as well as areas for related authorised activities, similar to the provisions of the ‘Fire Safety Standard for underground car parks’, reference number **NP 127**.

**(5)** Car parking spaces in the floor shall be marked and numbered visibly on the floor, with signposting signs.

**Article 3.2.11.11. (1)** Car access and traffic ramps in above-ground car parks shall be free to a minimum height **2.15** m (measured perpendicular to the ramp).

**(2)** The maximum height of passenger cars that can enter the park shall be specified externally at each access ramp.

**Article 3.2.11.12.** Car parks will have possibilities to evacuate users in the event of fire, with standardised distances set out in Table 88.

**Table 88: Escape lengths in car parks**

Reference No	Construction (building) civil	Fire stability level provided	Maximum escape length		Remarks
			in two different directions	in a direction (dead-end corridor)	
			metres	metres	
1.	Parking for cars	<b>I and II</b>	<b>40 (50)</b>	<b>25 (30)</b>	-
		<b>III</b>	<b>30</b>	<b>20</b>	
		<b>IV and V</b>	<b>16</b>	<b>12</b>	

Notes:

- 1) A dead-end corridor with a length less than the maximum length of discharge in one direction (dead-end corridor) measured from an outlet with access to second stairways, buffers ventilated under excess pressure, or exits located in different directions, is considered to be the permitted escape path if the total distance to a staircase, ventilated buffer room overpressure or outwards does not exceed the maximum length of escape in two directions and the distance to be travelled in the same direction shall not exceed the length of the dead-end corridor.

- 2) *Stairways may not be provided with several successive buffer traps for the purpose of entering the normal distance of the escape horses.*
- 3) *The values in brackets apply to heavily ventilated parks.*

**Article 3.2.11.13. (1)** Ensuring the escape of users of underground parking areas shall be carried out according to the specific, indicative legislation **NP 127**.

**(2)** The number of users simultaneously in the above-ground car park and per parking level shall be indicated in the technical design documentation.

**(3)** To determine the number of users, a simultaneity of 15% of the number of parking spaces and two people in each car is considered.

**Article 3.2.11.14. (1)** Escape staircases for users of the above-ground or underground car park for a maximum of **10** passenger cars may be provided inside the construction (stairway enclosures in staircases), or outside it (open stairways), constructed and protected according to the provisions of the legislation.

**(2)** Gaps of access to staircases enclosed in the park shall be protected by protected buffers ventilated in excess pressure with doors **EI<sub>2</sub> 60-C5 MS**, if the Rule does not set more stringent conditions.

**(3)** Escape staircases external to the car park shall be positioned in such a way that they are protected from any flames in the car park (against full walls) **EI 30** exceeding the scale by at least **3.00 m** or at a minimum distance **3.00 m** in relation to the outer wall of the car park.

**(4)** Access from car parks to open external escape stairways shall be achieved through a minimum fire resistant door **EI<sub>2</sub> 30-C5**, if the normative does not set more stringent conditions.

**Article 3.2.11.15. (1)** Spaces in above-ground car parks for related activities referred to in the Fire Safety Standard for underground car parks, indicative **NP 127** treat accordingly.

**(2)** Rooms for utility installations are separated from car parks by walls **REI 180** and floors **EER 120** communication glass shall be protected with fire resistant and smokeproof doors **EI<sub>2</sub> 90-C5S<sub>200</sub>**.

**(3)** Garbage rooms and household attachments (tenants' boxes) shall be divided from the park with fire resistant walls **EI 120** and communication voids shall be protected with fire resistant and smokeproof doors **EI<sub>2</sub> 90-C5S<sub>200</sub>**.

**(4)** Surveillance areas, pay cameras and car park operating offices are constructed with profile structures of the reaction to fire class **A1** or **A2-s1d0** and filling panels of glazing elements (of glass) simply or insulating, or of products classified as reaction to fire **A1** or **A2-s1d0**.

**(5)** Walls of the well of lifts for persons or goods in above-ground car parks with more than **10** cars, must be **A1** or **A2-s1d0** minimum fire resistant **EER 180** and the access gaps in it shall be protected with protected buffer rooms ventilated in excess pressure with fire-resistant and smokeproof doors **EI<sub>2</sub> 60-C5S<sub>200</sub>** if the Rules does not set more stringent conditions.

**(6)** Walls of the well of lifts for passenger or cargo and the walls of staircases enclosed in car parks with more than **2** cars and maximum **10** cars, including, must be **A1** or **A2-s1d0** minimum fire resistant **EER 120**, and the access gaps in them shall be protected with protected buffers ventilated in excess pressure with fire-resistant and smoke tight doors **EI<sub>2</sub> 60-C5S<sub>200</sub>** if the normative does not set more stringent conditions.

**Article 3.2.11.16. (1)** To limit light fire propagation between closed overground parking levels and underground closed with a maximum of **10** cars inner ramps for the circulation of passenger cars shall meet the following conditions:

- a) be bounded with minimum side walls; **EI 60** or where side walls are not provided to protect those wells with open sprinkler curtains, if the park is equipped with sprinkler fire-fighting systems, and diaphragms **EI 15** of minimum **50 cm** height positioned below the floors between parking levels;

**b)** car access gaps on internal ramps at each parking level shall be protected by open sprinkler curtains, without the requirement to provide diaphragms, in all cases where the car park is equipped with sprinkler fire-extinguishing systems.

**(2)** Open sprinkler curtains shall be dimensioned and carried out according to the provisions of the specialised technical regulations, ensuring:

**a)** the standard spray intensity;

**b)** theoretical operating time of **60 minutes**.

**Article 3.2.11.17. (1)** Parts of overground parking intended solely for the use of passenger cars and constituting closed tunnels for their traffic of more than **50.00 m** comply with the following:

**a)** the width of the tunnel shall be dimensioned to allow occupants to exit cars;

**b)** the maximum distance to an exhaust outlet of users shall not exceed **40.00 m**;

**c)** when the car park is equipped with a smoke discharge system by mechanical ventilation, a volume of **900 m<sup>3</sup>/hour** per fraction (s) of **5.00 m** from tunnel length, value that can be reduced to **600 m<sup>3</sup>/hour** per fraction of **5.00 m** from the length of the tunnel, if the car park is equipped with an automatic sprinkler fire-extinguishing system;

**d)** safety lighting is provided;

**e)** if the car park is equipped with automatic signalling and sprinkler fire-fighting systems, they shall also protect the tunnel intended for the use of passenger cars.

**(2)** The discharge of smoke may be carried out by own installations or with the exhaust installations associated with the car park, provided that the respective flow rate is also taken into account in the calculation.

**Article 3.2.11.18. (1)** Lift platforms and passenger car lifts shall be designed and carried out according to the provisions of the specific technical regulations, with due regard also to the following:

**a)** fit in wells separated from the rest of the building with minimum fire resistant walls **EI 120**;

**b)** station doors will be fire-resistant **EI 90** (or by providing access bands separated by doors **EI<sub>2</sub> 90-C5S<sub>200</sub>**);

**c)** station or pallier doors shall be provided with a threshold of **2.5 cm** or the floor coverings shall have slopes so as to avoid leakage of liquids into the well of the lift platform or lift;

**d)** the operation of the fire signalling installation in the park shall automatically control the lifting platform or lift to the reference level.

**e)** inscriptions relating to the obligation to stop the engine after the car has been positioned on the lift platform or in the lift; on above-ground parking areas of the type **P1, P2, P3** and **P4**, it is mandatory to equip sprinkler curtains open for the protection of gaps of access to wells of elevating platforms.

**(2)** Provision shall be made for inscriptions relating to the obligation to stop the engine after the car has been positioned on the lift platform or lift.

**(3)** Lift platforms and passenger car lifts shall be equipped with devices which in the event of fire automatically bring them to the reference level.

**Article 3.2.11.19.** At accessible above-ground car parks **only specially employed staff** for parking (where the public does not have access to car placement in parking spaces with lifts or elevating platforms for access to the above parking levels, the following shall be ensured:

**a)** elevating platforms and lifts for car access to above-ground car parks shall be placed, dimensioned and carried out according to the provisions of the specific technical regulations and of this legislation.

**b)** lift platforms and passenger car lifts shall be equipped with devices which in the event of fire automatically bring them to the reference level.

- c) it is mandatory to power lift floating platelets and lifts for passenger cars from two electric power sources or with thermal or combined motor or combined motor fuel
- d) lift platforms and car access lifts shall be fitted in wells separated from the rest of the building with fire-resistant walls **EI 120** station doors will also be fire-resistant **EI 60** (Or by providing access bands separated by doors **EI**)<sub>2</sub> 60-C5S<sub>200</sub>
- e) station or pallier doors shall be provided with a threshold of **2.5 cm** or the floor coverings shall have slopes so as to avoid leakage of liquids into the well of the lift platform or lift;
- f) the operation of the fire signalling installation in the park shall automatically control the lifting platform or lift to the reference level.
- g) intervention and rescue staircases shall be provided, at least one at **500 00 m<sup>2</sup>** of parking, regardless of the length of escape provided;
- h) in above-ground car parks of the type **P1, P2, P3** and **P4** it is mandatory to equip sprinkler curtains with open sprinkler curtains to protect gaps of access to wells of elevating platforms, if automatic sprinkler extinguishing system is provided in the park.

**Article 3.2.11.20.** On above-ground car parks **where the public and staff employed do not have access**, where the layout of cars in parking spaces is ensured with automated distribution systems other than lifts or elevating platforms for access to above ground parking levels, the following shall be ensured:

- a) for above-ground car parks open to cars, the provisions of **Article 2.1.3.5. (1) point (a)** shall be complied with; above-ground open car parks with area (Ac) greater than **3 000 m<sup>2</sup>** and more than **3** above-ground levels will comply with the level **I** or **II** of fire safety equipment in agreement with **Table 2**;
- b) closed overground car parks will comply with the level **I** or **II** of fire safety equipment in agreement with **Table 2**;
- c) intervention and rescue staircases shall be provided, at least one at **3 000 00 m** of parking, regardless of the length of escape provided.

**Article 3.2.11.21. (1)** In above-ground car parks closed for more than **10** motor cars shall evacuate smoke and hot gases in the event of fire shall be carried out according to the Fire Safety Standard for underground car parks, reference number **NP 127**.

**(2)** Closed car parks with a capacity greater than **5** parking spaces, but maximum **10** places shall have exhaust of smoke and hot gases produced in the event of fire by natural and organised draught, providing a free aerodynamic area of **1 %** from the useful floor area of the car park, or by mechanical ventilation.

**(3)** In open car parks above ground, smoke and hot gas outlet voids in the external walls shall only be taken into account for a depth not exceeding **30 m**, a situation where the conditions for the exhaust of smoke and hot gases are considered to have been assured. If smoke discharge voids in the external walls do not meet the above mentioned requirement, it is necessary to evacuate smoke and hot gases from above-ground open parks according to the provisions of Rule **NP 127**.

**Article 3.2.11.22.** In above-ground car parks with more than **8** levels shall be provided at least with one intervention lift in the event of fire (fire brigade) for each of the separations referred to in **Article 3.2.11.5 (1)**, easily accessible from the terrain, partitioned and with priority call for firefighters.

**Article 3.2.11.23. (1)** For intervention in the event of fire, at closed or open above-ground parking areas, at least one road access route appropriate to heavy traffic shall be provided to enable the use and operation of fire-fighting vehicles.

**Article 3.2.11.24. (1)** The parks shall be equipped with fire protection installations according to the specific technical regulations and of this Rule.

(2) Car parks with more than **10** cars shall be fitted with emergency exhaust lighting, constructed and constructed according to the provisions of the relevant technical regulations and of this Rule.

(3) Road traffic in above-ground car parks, including car ramps, shall be provided with a safe lighting installation, supplied and carried out according to the applicable technical regulations, so as to ensure the minimum level of illumination required for safe traffic. Emergency skylights shall be fitted both at the top and at the bottom of traffic spaces, as appropriate, in the floor. In the utility areas of the above-ground car park, safety lighting shall be carried out according to the provisions of the applicable technical regulations.

(4) Emergency lighting for the escape of users from the building shall consist of luminous points at the top and bottom of the escape routes, with minimum operation **60 minutes** for above-ground open car parks, and **180 minutes** for above-ground car parks. In the case of overground parking areas open in high, very high buildings or with crowded rooms of categories S1 and S2, or in the following functions: commercial premises, worship, culture, tourist accommodation, education, railway stations and aircrafts, social care centres, health with hospitalisation, safety lighting for the escape of users shall have minimum operating time **180 minutes**.

(5) It is recommended that the luminous points at the top as well as those at the bottom should be fitted to the fullest extent. **15.00 m** distance between each other for each other. Along the escape routes, the distance between the skylights for the escape must be within the conspicuity distances prescribed by **SR EN 1838**.

(6) Each luminous point is recommended to have a minimum luminous flux **45 lumens** over a period of **60 minutes** (or **180 minutes** in the case of enclosed above-ground car parks) and minimum mandatory **1 lx** at any point of escape routes at floor level.

(7) Illuminating points at the bottom may be embedded in the floor provided that the required mechanical strength is observed or located close to the floor.

(8) Illuminating points at the bottom which do not bend in the floor shall be provided not more than **0.50 m** above the floor provided that the skylights are mechanically protected.

**Article 3.2.11.25.** In above-ground car parks, two basic and back-up power sources are mandatory (according to the provisions of the legislation) **I7**), the following vital consumers:

- a) fire detection and signalling facilities;
- b) water fire-fighting systems;
- c) smoke escape systems by mechanical ventilation;
- d) means intended to alert users;
- e) lifts for disabled persons;
- f) firefighter lifts (intervention in the event of fire), where mandatory;
- g) lift platforms and lifts for passenger cars;
- h) fire resistant curtains.

**Article 3.2.11.26.** Enclosed above-ground car parks will have emergency services set up and organised according to the specific regulation.

**Article 3.2.11.27. (1)** In above-ground car parks for more than **10** cars, access and intervention routes shall be provided for firefighting and user rescue vehicles.

(2) Access for intervention in the event of fire shall be provided on at least one road allowing the movement of intervention vehicles.

(3) The access routes and functional internal movements of the car parks shall be kept permanently in use, so that where necessary they can be used by emergency response services.

(4) Above-ground car parks shall allow access to the emergency services vehicles in the following way:

- above-ground car parks type **P1**: an accessible façade served by a minimum of one route so as to allow access to emergency services vehicles to a minimum **25 %** of the perimeter of the external walls

- above-ground car parks type **P2**: one accessible façade fully served by a route and a second partially accessible from the served side so as to allow access to emergency service vehicles to a minimum **35 %** of the perimeter of the external walls
- above-ground car parks type **P3**: a minimum of two accessible façades served by full traffic routes, so as to give access to emergency services vehicles to a minimum **50 %** of the perimeter of the external walls
- above-ground car parks type **P4**: three facades that are accessible, sensibly distributed and served by traffic routes, so as to give minimum access to emergency services vehicle **70 %** of the perimeter of the external walls

**Article 3.2.11.28.** A minimum of one portable extinguisher with extinguishing performance shall be provided in car parks **21A** and **113B** on each **10** parking spaces as well as a transportable extinguisher with fire extinguishing performance types A and B of minimum **50 kg** each **500 m<sup>2</sup>**.

## SECTION III

### 3.3. Outdoor constructions and facilities for civilian use

#### 3.3.1. General provisions

**Article 3.3.1.1.** Outdoor facilities for civilian use, such as meetings, concerts, cinemas, performances, sports competitions, etc., shall ensure compliance with the fire safety measures laid down in the regulations and regulations specific to them.

**Article 3.3.1.2.** Outdoor facilities shall be equipped with means of first intervention, ensuring a portable extinguisher with the minimum extinguishing performance **21A** and **113B** on each **250 m<sup>2</sup>** and a transportable extinguisher with outbreak extinguishing performance type A and B with nominal load of **50 kg** maximum **1,000 m<sup>2</sup>**.

#### 3.3.2. Stadiums, sports arenas

**Article 3.3.2.1.** Outdoor sports facilities such as stadium or sports arena with seating positions shall comply with the fire safety measures laid down in the regulations and regulations specific to them.

**Article 3.3.2.2.** Courts and spaces for outdoor sports facilities shall have fire risks specified, in accordance with the provisions of **Article 2.1.2.2.**

**Article 3.3.2.3. (1)** The fire stability level of sports facilities shall be determined and specified in accordance with the provisions of **Article 2.1.3.2.** and Table 2 of the legislation.

**(2)** It is recommended to ensure the fire stability level I or II of the building.

**(3)** Areas intended for public use shall have a minimum structural strength of R 15 and shall be made of materials of reaction to fire class A1 or A2-s1, d0. The steps (flooring) shall be made of materials of reaction to fire class A1 or A2-s1.

**Article 3.3.2.4. (1)** Outdoor sports facilities shall be located in such a way that they do not allow fires to spread to neighbours for the standard period of time or in the event of collapse to affect neighbouring objects, while respecting the minimum safety distances.

**(2)** Outdoor sports facilities with higher simultaneous capacities of **400** users, normal safety distances will be increased by **100 %** and the construction products used will ensure the containment of smoke, hot gases or other harmful products and the spread of flames and smoke.

**Article 3.3.2.5.** By complying with outdoor sports facilities with functions of sports stadiums or sports arenas, user public spaces will be arranged at a minimum distance from **1,20 m** from the playing field, and the directions of evacuation of users on common circulations will be provided to areas opposite the playing field.

**Article 3.3.2.6.** Outdoor sports facilities for more than **200** users will be ensured as a minimum **2** suitably arranged and dimensioned escape routes through which they reach the level of the surrounding terrain or adjacent road traffic along the normal distances.

**Article 3.3.2.7.** The number of entries in the tribunes is determined by the number of spectators and escape routes, as well as the need for controllers. If the access and evacuation of the tribunes is via vomitoriums, in order not to generate a bang in case of emergency evacuation, it is recommended to size them by 50% more than the standard evacuation calculation.

**Article 3.3.2.8.** User access and escape routes shall consist of functional movements, suitably sized, visibly marked and free from any obstacle, so that the evacuation of users can take place safely. Special (emergency) escape routes may only be provided when functional traffic does not satisfy the normal discharge conditions.

**Article 3.3.2.9.** The maximum distance between a place in the gallery and the nearest exit (evacuation of the gallery representing the departure of all spectators' seats from the gallery and passing them from the 'gallery access points' to the enclosure outside the gallery) shall be: **45,00 m** (for fire stability level **I** or **II**, for other classifications in the stability level, the values set out in the specific normative shall be used), as follows:

- for standing or bench seats, this distance is the line joining the site with the nearest exit;
- for seating positions, this distance is the sum of the length of the yield and that of the lateral path from that place to the nearest exit.

**Article 3.3.2.10. (1)** The sizing of access and escape routes in the galleries shall comply with the following:

- access routes around sub-sectors will not be less than **1.20 m**.
- shall be taken as the minimum width of passage **1.20 m** (i.e. the width ensuring the evacuation of a number of **100** persons within one minute under reasonable conditions, either an Exit Module - E.M.). Two persons may pass through an exit module at the same time.- the planned maximum exit time in the event of an emergency of **270** seconds (relative to an average speed of **0.35 m/sec**, evacuation of the gallery representing the departure of all spectators' seats from the gallery and passing them from the 'gallery access points' to the enclosure outside the gallery). This time is included in the permissible mean escape time of the stadium (representing the passage of the outer enclosure of all spectators), which is **8 - 10** minutes.

**(2)** The calculation of the exhaust flow of an outlet shall be made by dividing its width by the width of the output module, and then multiplied by the number of spectators resulting from the maximum discharge time of the gallery (**450** by spectators in the case of **270** seconds, relative to an average speed of **0.35 m/s**), normally the sum of individual outflow capacities should be a measure of the stadium spectator capacity (gallery).

**Article 3.3.2.11. (1)** The width of the functional and evacuation routes of users from the galleries shall be determined in accordance with the provisions of this Regulation and the specific regulations, depending on the arrangement of the places and the number of users to be evacuated, but at least **1.20 m** for evacuation of a maximum **200** users and minimum **1.60 m** for more than **200** users.

(2) The width of exhaust stairway ramps shall be determined by the number of exhaust pass-through units (flows) from the most congested level.

(3) The width of the escape ladders shall be min. **1.20 m** for max. **200** individuals and min. **1.40 m** for more than **200** individuals.

(4) Escape ladders of stadiums and outdoor sports areas may be open.

(5) The width of circulations between sectors (parallel and perpendicular to graduations), shall be at least **1.20 m**.

(6) For access, circulation and evacuation of users from the steps, the stairs will have equal widths.

(7) Perpendicular movements for more than **15** steps having slope (angle of inclination to the horizontal) greater than **25°**, provision shall be made for user support points.

**Article 3.3.2.12.** In open stadiums and outdoor sports areas, the maximum number of seats permitted on a row of seats shall be standardised according to the level of fire stability provided and the way in which users are evacuated in a row, in accordance with the provisions of Table 89.

**Table 89: Maximum number of seats permitted in a row of seats**

<i>Evacuation mode of users in a row of seats</i>	<i>Fire stability level of the building</i>		
	<i>I and II</i>	<i>III</i>	<i>IV and V</i>
	<i>Number of seats in a row</i>		
<i>On one end of the row</i>	<b>25</b>	<b>15</b>	<b>10*</b>
<i>On both ends of the row</i>	<b>50</b>	<b>25</b>	<b>20</b>

Note:

\* = in stadiums, arenas and open areas with fire stability level **IV** or **V**, it is mandatory to ensure that rows of seats are evacuated at both ends.

**Article 3.3.2.13.(1)** The clear distance between rows of seats shall be at least **35 cm**.

(2) Where traffic barriers are provided, they shall be so designed and located as not to impede the safe movement and evacuation of users in the event of fire.

**Article 3.3.2.14. (1)** Outdoor sports facilities will be provided with an appropriate signalling system to ensure safe evacuation, avoiding confusion and panic.

(2) Outdoor sports facilities shall be provided with orientation signs and shall be equipped with electrical installations for safety lighting (for evacuation, panic lighting, traffic lighting, lighting of indoor hydrants and fire pump stations, etc.). The type and electrical supply of emergency lighting shall be ensured in accordance with the provisions of the ‘Standard for the design, execution and operation of electrical installations related to buildings’, reference number **I 7.**”.

**Article 3.3.2.15.** Outdoor sports facilities shall have access and intervention facilities for fire-fighting vehicles on at least 2 accessible facades served by full circulation routes, so as to allow access for emergency services vehicles on at least **50%** of the perimeter of the exterior walls.

### **3.3.3. Outdoor performances facilities and tents**

**Article 3.3.3.1. (1)** Uncovered outdoor performance facilities are considered to be of stability level **IV** or **V** and shall be set back from neighbouring buildings at the standard safety distances according to Table 4, measured from the boundary of the facility. For outdoor facilities with higher simultaneous capacities of **400** users, increase the safety distance by **100%**.

(2) By complying with the arrangements, the spaces for the public users will be arranged at distances of at least 3 m from the stages and game podiums, and the evacuation directions of the users on the common circulations will be ensured towards areas opposite the stage or game podium.



(3) The spectator steps shall have non-combustible strength structures of minimum **R 15**, and platforms (podiums) made of class **A1** or **A2-s1,d0** reaction to fire materials.

(4) The structural elements of stands, tribunes, podiums, etc. shall be made of materials with minimum reaction to fire classes **A2 d0** or **D1**.

(5) The use of floral decorations of synthetic materials must be limited; otherwise, they must be made at least of materials with the classes **Cs1÷s3,d0** or **d1**.

(6) It is forbidden to mark off areas along escape routes with chains, ropes, etc. at a height of less than **1 m**. Marking and signalling objects - flags, ribbons, pennants, etc. - shall be provided on the means of marking off areas.

**Article 3.3.3.2. (1)** Uncovered open-air facilities for more than **200** users shall be provided with a minimum of **2** properly laid out, designed and dimensioned escape routes, through which they can reach the level of the surrounding ground or adjacent roadways.

(2) The maximum permissible escape length of the route on the escape routes from the furthest place to access to terrain level or road traffic shall not exceed **200 m** when evacuation is provided in two directions and maximum **100 m** when evacuation is provided in a direction.

(3) The width of exhaust circulations shall be determined by calculation, in accordance with the provisions of the standard.

**Article 3.3.3.3. (1)** Outdoor facilities shall be constructed within the area boundaries established by local councils with the approval of emergency inspectorates and, where applicable, other authorities, in accordance with legal provisions.

(2) In all temporary arrangements in open spaces, when installing utilities such as electricity, water, gas, the air route shall be made at a height of at least **3.5** metres, so that access to the means of intervention is not uncomfortable.

(3) Parking areas must be organised at a safe distance from the facility.

**Article 3.3.3.4. (1)** The ground-height tents shall meet the requirements of the specific legislation.

(2) The tents in which a level (storey) other than the upper storeys and steps provided for in the standard must meet the following conditions:

- to be considered a tent, the membrane must constitute at least **75%** of the building envelope.

- may be arranged only for the following functions:

a) civilian: catering, events, fairs, circuses, sports activities or exhibitions;

b) production and/or storage.

- be fitted with a minimum strength structure **R30** (including level) **and** maximum area of **1,500 m<sup>2</sup>**;

- be placed at a distance equal to or greater than **1.5 H** from overhead power lines with a rated voltage equal to or greater than **1,1 kV**.

- the tent membrane must provide a **minimum** reaction to fire **class B-s2d0**;

- structural lashing cables shall be made of materials classified in the reaction to fire class **A1** or **A2-s1d0**

- shall be provided with a minimum of two escape routes;

- tents shall be considered as fire integrity level **II** constructions with a partially protected metal structure and the length of escape routes measured from any point inside the tent to the nearest exit to the outside, taking into account items of furniture or any other obstruction encountered on the escape routes, shall comply with the performance provisions specific to each destination, without being compulsory to stiffen the tables and chairs on the floor or between them in this way:

a) for those with civil functions: catering, fairs, circuses, sports activities, events, exhibitions; maximum **20** m in a direction and maximum **40** m in two directions

b) production and/or storage.

low or medium risk - maximum **20** m in one direction and maximum 40 m in two directions

high risk - maximum **20** m in one direction and maximum **35** m in two directions on the ground floor and maximum **25** m in two directions upstairs.

very high risk - maximum **20** m in one direction and maximum **30** m in two directions on the ground floor and maximum **25** m in two directions upstairs.

- the minimum clear width of any outbound exit, depending on the maximum number of users, shall be in accordance with the profile standard and the minimum clear height shall be at least **2.10** m;

- the other provisions of the profiling rules (food preparation/heating attachments/spaces, as well as those using open fire), escape routes, decorations and finishes, crews, utility installations, operating conditions not contrary to the above shall be complied with.

**Article 3.3.3.5. (1)** In temporary facilities in inflatable structures (structures whose walls or envelopes are supported by air introduced directly or through inflatable fittings) the following shall be taken into account:

- temporary facilities in inflatable structures, for more than **30** users, are only carried out outdoors;

- in structures intended for temporary outdoor facilities, spaces and installations must not be created for: stages with sets or floors made of combustible materials and/or libraries;

- structures shall be located on surfaces which do not present a fire risk;

- where structures in temporary arrangements house more than **300** people, they must be located close to a water source providing a flow of at least **18** cubic metres per hour and not more than **200** metres away; water flow shall be ensured for at least one hour; if the above conditions cannot be fulfilled, the organiser shall be required to ensure equivalent capacity by means of appropriate intervention;

- a safety perimeter of a minimum width of 1 metre shall be provided around the structures of the temporary arrangements, marked with ropes, strips, barriers; the area shall be signalled and marked accordingly; access shall also be denied to the anchorage of structures and to the area of fans;

- the sloping location of structures within temporary developments shall be avoided as far as possible.

- the distance between structures within the same facility must be at least: **4** metres, if the two structures present the same type of fire risk, or **8** metres, if the two structures present different fire risks (distances are measured horizontally from the foot of the structures); two access routes are provided for each structure, preferably on opposite sides; parking vehicles along these routes shall be prohibited;

- the following appliances shall be prohibited within inflatable structures: open flame apparatus, incandescent or capable of discharging incandescent elements, combustible gas appliances and direct heat air generators instead.

- the other provisions of the profiling rules (food preparation/heating attachments/spaces, as well as those using open fire), escape routes, decorations and finishes, crews, utility installations, operating conditions not contrary to the above shall be complied with.

**Article 3.3.3.6. (1)** In any facility, regardless of the type of event organised, marking and signposting shall be ensured:

a) access, evacuation and intervention routes;

b) smoking sites;

- c) assembly places;
- d) parking spaces;
- e) the initial means of intervention.

(2) Guidance signs shall be provided on escape routes and safety lighting shall be provided in accordance with the relevant technical regulations.

**Article 3.3.3.7. (1)** The first intervention shall be provided with portable extinguishers appropriate to the local fire risk, which shall be located visibly, easily accessible, typically close to the access/escape routes.

(2) Minimum provision of technical fire-fighting equipment for temporary indoor installations:

- one portable extinguisher at each **200 m<sup>2</sup>**, but not less than two per level (the maximum distance travelled to reach an extinguisher must not exceed **15 metres**.)

- one portable fire extinguisher to cover each localised hazard (or groups of hazards of the same nature):

- a) for electrical equipment (switchboards, electronic or computer equipment, etc.) - an extinguisher with **CO<sub>2</sub>** for minimum outbreak **55B**;

- b) for rooms where lacquers, paints, polystyrene, fats or oils are stored - one powder fire extinguisher at least compliant with fire standards **21A** and **113B**;

- c) warehouses higher than **3 m** or for the storage of pallets, cartons, plastics, waste, garbage - a water spray extinguisher, for minimum outbreak **21A, 113B**;

- in kitchens it is recommended that every cooking appliance be equipped with a fire blanket.

- in mobile extinguisher of minimum **50 kg/l** for each structure within the temporary accommodation, with a surface larger than **500 m<sup>2</sup>**.

(3) Minimum provision of fire-fighting equipment for temporary outdoor installations:

- a portable powder fire extinguisher to every leisure installation or item of leisure equipment;

- a portable extinguisher for electrical equipment (switchboards, electronic or computer equipment, etc.) - an extinguisher with **CO<sub>2</sub>** for minimum outbreak **55B**;

- in kitchens it is recommended that every cooking appliance be equipped with a fire blanket;

- a mobile extinguisher of minimum **50 kg/l** for each structure within the temporary accommodation, with a surface larger than **500 m<sup>2</sup>**;

- two portable fire extinguishers for each stage, each for minimum outbreak **34A, 144B**.

**Article 3.3.3.8.** Uncovered outdoor facilities shall have access and intervention conditions for fire-fighting vehicles on at least 2 sides.

### **3.3.4. Campsites**

**Article 3.3.4.1.** Campsites (facilities for tents, caravans, provisional boxes, etc.), with or without utility structures, shall comply with the provisions of the legislation and the specific regulations.

**Article 3.3.4.2.** Utility constructions and annexes to campsites (commerce, clubs, discotheques, restaurants, leisure, social groups, centres and technical areas, etc.) shall comply with the specific performance provisions laid down in the legislation and the specialised technical regulations.

**Article 3.3.4.3.** Campsites should be located at minimum distances from **50 m** to neighbouring constructions, including international or national roads and to a minimum **100 m** relative to running railway lines.

**Article 3.3.4.4. (1)** By organising the campsite premises, camping platforms with a maximum area of 1,000 m<sup>2</sup> shall be created, delimited by properly marked roadways, allowing the intervention of fire-fighting equipment.

**(2)** To limit the spread of fires between camping platforms (each with a maximum of **1,000 m<sup>2</sup>**), at least the normal safety distance between constructions with the level of **V** fire stability.

**Article 3.3.4.5.** It is recommended that campsites with a total area of more than **3,000 m<sup>2</sup>** be provided with means of alarming users and with the possibility of alerting emergency units in the event of fire.

**Article 3.3.4.6. (1)** It is recommended that in campsites with the area of **5,000 m<sup>2</sup>** and more, fire-fighting systems with networks of external fire hydrants shall be provided or mobile or fixed water tanks and extinguishing pumps shall be provided. Fire-extinguishing rate shall be at least **5 l/s** for a period of operation of **60** minutes.

**(2)** Campsites and their utility buildings shall be equipped and endowed with technical means of fire protection, in accordance with the provisions of the regulations and technical regulations.

**Article 3.3.4.7.** Campsites will be provided with access to and intervention of fire extinguishing vehicles at least on one side.

**Article 3.3.4.8.** Emergency services are set up and organised at campsites in accordance with specific regulations.

## **CHAPTER 4**

### ***4. PERFORMANCE SPECIFIC TO HIGH, VERY HIGH OR CROWDED CIVIL BUILDINGS ABOVE GROUND LEVEL***

#### **SECTION I**

##### **4.1. High above-ground civil buildings**

###### ***4.1.1. GENERAL BUILDING PERFORMANCE CONDITIONS (FIRE RISK, FIRE STABILITY LEVEL)***

**Article 4.1.1.1. (1)** High above-ground civil buildings, including those parts of them with heights lower than the limit for classification as elevated buildings, shall be provided with fire stability level I.

**(2)** The fire stability level of the building shall be determined according to Art. 2.1.3.2 and Table 2.

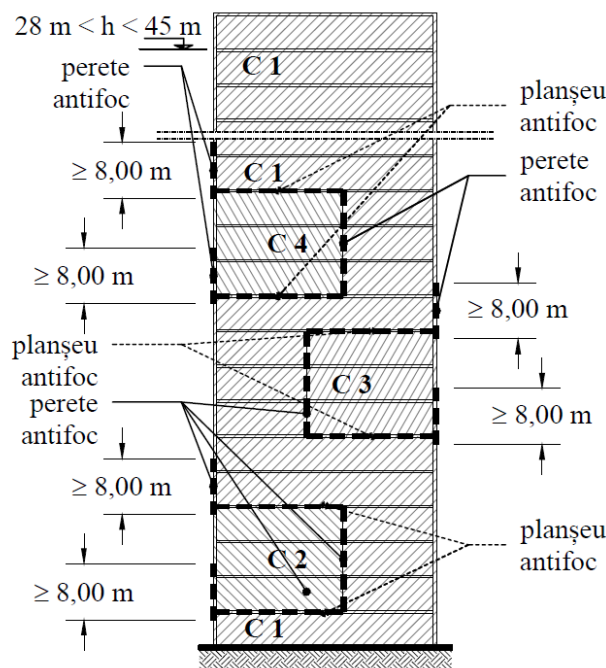
###### ***4.1.2. LOCATION AND COMPLIANCE OF BUILDINGS***

**Article 4.1.2.1. (1)** Merging with each other or with other high civil engineering structures within the same fire compartment shall be prohibited.

**(2)** The minimum fire safety distances that must be provided between high above-ground civil buildings and other buildings are set out in Art. 2.2.1.2. and Table 4.

**(3)** High above-ground civil buildings may be subdivided throughout their height with fire bulkheads within the built area (**Ba**) not exceeding **3,500 m<sup>2</sup>** in any number of fire compartments. In a fire compartment of the raised building with the built area (**Ba**) not exceeding **3,500 m<sup>2</sup>** may be provided up to three volumetric portions thereof (as shown in Figure 69), with the total area developed (**Da**) of each volume portion not exceeding **3,500 m<sup>2</sup>** (without possibility of increment), portions consisting of one to three successively constructed levels delimited by fire floors and, where appropriate, fire bulkheads by the fire compartment into which they are inserted.

**(4)** Within a fire compartment not equipped with an automatic sprinkler-type water fire-extinguishing system, with a built-up area (**Ba**) of not more than **3,500 m<sup>2</sup>**, a single volumetric portion may be provided (as shown in Figure 8 Variant b), with a total developed area (**Da**) of not more than **3,500 m<sup>2</sup>** (with no possibility of increase), consisting of one to three successive built-up levels bounded by fireproof floors and, where appropriate, fire walls, provided that all compartments are equipped with a fully enclosed fire detection, signalling and fire alarm system and are not equipped with an automatic sprinkler system. Where compartments are not equipped with an automatic sprinkler-type water fire-extinguishing system and a fully enclosed fire detection, signalling and alarm system, within a fire compartment with a maximum built-up area (**Ba**) of **3,500 m<sup>2</sup>**, a single volumetric portion may be provided (as shown in Figure 8 Variant a)), with a total developed area (**Da**) of not more than **2,500 m<sup>2</sup>** (without the possibility of increase), consisting of one to three successive built-up levels bounded by fire stopping ceilings and, where appropriate, fire walls.



**Legend:**

**C1, C2, C3, C4** - separate **fire compartments**, fire stability level I

Fire compartment areas:

C1 Compartment\* (high building with any operation except dwelling) – Built area  $\leq 3,500 \text{ m}^2$

C2 Compartment (high volumetric building compartment) - Developed area  $\leq 3,500 \text{ m}^2$

C3 Compartment (high volumetric building compartment) - Developed area  $\leq 3,500 \text{ m}^2$

C4 Compartment (high volumetric building compartment) - Developed area  $\leq 3,500 \text{ m}^2$

Note\*: Where the C1 Compartment is additionally equipped with a sprinkler automatic fire extinguishing system, its built area is  $\leq 5,250 \text{ m}^2$

28 m < h < 45 M	28 m < h < 45 M
perete antifoc	fire wall
planșeu antifoc	fire floor

**Figure 69 Fire partition and fire compartment areas in high rise civil above-ground buildings and fire compartments**

**(4)** The built-up areas of buildings or fire compartments over their entire height, which are standardised at **3,500 m<sup>2</sup>**, may be increased by **50%** when equipped with water sprinkler systems in addition to the provisions of the relevant standard.

**Article 4.1.2.2. (1)** Fire walls separating fire compartments shall be **EI-M 180/REI 180** reaction to fire class **A1, A2-s1d0** and where applicable, the floors separating the fire compartments shall be **REI (fire-resistant floorboards)**, reaction class to fire **A1, A2-s1d0** with fire resistance determined according to the density of the heat load (**q**) in adjacent rooms in accordance with the provisions of **Article 2.3.1.2.** and **Table 5** but minimum **120** minutes (**REI 120**).

**(2)** Functional communication can be provided by gaps in fire resisting walls EI-M 180/REI 180 separating fire compartments (fire walls), by protected, overpressure ventilated buffer rooms equipped with fire resistant and smoke tight doors minimum **EI<sub>1</sub> 60-C5S<sub>200</sub>**.

### **4.1.3. LIMITING THE SPREAD OF FIRES**

**Article 4.1.3.1.** In high civilian buildings it is not recommended to place rooms with high fire risks and, where they are functionally justified, they shall be provided in separate areas and only with the provision of appropriate protective measures, i.e. partitioning from the rest of the building with vertical and horizontal fire resistant elements which are constructed and dimensioned in accordance with the fire risk and the density of the heat load (**q**), equipped with automatic signalling and fire-fighting systems, etc.

**Article 4.1.3.2.** Rooms with very high fire risks shall not be permitted in high above-ground buildings, with the exception of those separated according to **Article 4.1.4.8.** and Table 90.

**Article 4.1.3.3. (1)** In the context of elevated civil engineering works, it is ensured that the rooms are separated from the rest of the construction in accordance with the provisions on common performance as well as those specified in this chapter and, where the standard does not have internal partition walls designed to limit the propagation of fire and/or through sectoral walls in accordance with the provisions of **Article 2.1.3.2.** and Table 2, depending on their height regime.

**Article 4.1.3.4. (1)** When separating groups of open-plan office rooms from other rooms, with the surface area normalised according to **paragraph 2**, with low fire risk and the same use (own or complementary / offices and functional circulation delimited by partitions, panels or functional partitions of reaction to fire class **A1, A2-s1,d0**), minimum partition walls to limit the spread of fire to adjacent spaces (except those to escape routes complying with specific provisions and those to rooms with a higher risk due to the density of the thermal load in adjacent rooms), which must be of reaction to fire class **A1, A2-s1,d0** minimum **EI/REI 120** fitted with fire-resistant and smoke-tight doors **EI<sub>2</sub> 60-C5S<sub>200</sub>**.

**(2)** Groups of open open-space office rooms delineated within the pool by opaque panels or glazed panels, fixed or mobile (reaction to fire class **A1, A2-s1, d0**, except for non-substantial components, glazing (glass) elements and glazing fittings) used as functional separation and/or sound insulation or functional internal walls or partitions (reaction to fire class **A1, A2-s1, d0**) shall be admitted with an unlimited built-up area in the administrative constructions of high buildings, provided that the built-up area of the groupings of office rooms open to it is not more than **75 %** that of the built-up area of the division level concerned for high-level administrative constructions.

**(3)** The groupings of open-space office rooms referred to in the preceding paragraphs shall have at least two separate and independent escape routes so arranged and constructed that they can be easily accessible to users for high administrative constructions at the level of **I** fire safety managers with administrative operation (offices). The evacuation routes of users shall comply with the composition conditions laid down in the regulations and the standard discharge lengths.

**(4)** The groupings of open office rooms will also comply with the requirements set out in **Article 2.4.3.2. paragraph 4** and in **Article 2.5.14.1.**

**Article 4.1.3.5. (1)** Premises for sale with a heat load density  $q$  of less than **840 MJ/m<sup>2</sup>** shall be separated from ancillary rooms which are not accessible to purchasers (social or functional annexes, offices, etc.) by fire-resistant walls of at least **EI/REI 120** and, where appropriate, **REI 120** fire-resistant floorboards, and the functional circulation and escape openings in these walls shall be protected by fire-resistant and smoke-tight enclosures of at least **EI<sub>2</sub>60-C5S<sub>200</sub>**. Enclosed rooms which are not accessible to purchasers and sales premises shall be separated in the same way. Open space groupings consisting of groupings of high, medium or low fire risk spaces with a commercial function in high-rise buildings shall not be allowed.

**(2)** Premises for sale with a heat load density  $q$  greater than or equal to **840 MJ/m<sup>2</sup>** (high or very high fire risk) are allowed only if separated according to Table 90 (boundary with walls, floors and doors or buffers ventilated in excess pressure, exceptions being excluded). Sales areas with density of heat charge above **2,940 MJ/m<sup>2</sup>** are not allowed.

**(3)** For sales premises with a heat load density  $q$  of less than **840 MJ/m<sup>2</sup>** in tall buildings it is permissible to replace fire resisting walls between sales spaces to horizontal common circulation (corridors and hallways) provided with independent mechanical smoke and hot gas exhaust systems with continuous **DH 90** screens located at the edge of the resistance elements to horizontal common circulation, having a height equal to that of the smoke tank, but not less than 1 m (smoke from the smoke tank must not extend to adjacent smoke areas in the circulation).

**(5)** Fire resisting walls between high and very high fire risk sales spaces and common vertical escape circulation (corridors and hallways) in high-rise civil commercial buildings shall comply with Table 90, but with minimum **EI/REI 180** and, where appropriate, with minimum **REI 120** fire resisting floorboards, and functional and escape circulation gaps in these walls shall be protected with fire resisting and smoke tight closure elements minimum **EI<sub>2</sub>90-C5S<sub>200</sub>**.

**Article 4.1.3.6. (1)** When separating groups of open-plan rooms which are not used by persons who cannot evacuate themselves (defined according to the terminology) (with the exception of administrative spaces and staff changing rooms, included in the health function) from other rooms, with the maximum standard surface area, with a low fire risk and the same use (own or complementary / functional spaces and circulation delimited by partitions, panels or functional partitions of reaction to fire class **A1, A2-s1,d0**), at least sector separating partitions shall be provided to limit the spread of fire to adjacent spaces (except those to escape routes complying with the specific provisions and those to rooms with a higher risk due to the density of the thermal load in adjacent rooms), which shall be of reaction to fire class **A1, A2-s1,d0** minimum **EI/REI 120** fitted with fire resisting and smoke-tight doors **EI<sub>2</sub> 60-C5S<sub>200</sub>** in high rise civil buildings.

**(2)** Groupings of rooms with low fire risk and the same destination, including collateral destinations, including horizontal functional communications (such as changing rooms + toilet facilities; desks + lock chamber access) as well as those specific to the health function (MRI room + command room + lock chamber access; tomograph computer camera + control room + smart access solutions, etc.) partitioned together with opaque panels or glazed panels, fixed or movable for use as functional separation and/or sound insulation or functional internal walls or partitions, shall be permitted in health buildings up to a maximum of **600 m<sup>2</sup>** provided that the built-in area of the open space is not more than **50%** that of the built-up area of the building/fire compartment level in question;

**(3)** Partition walls provided between the groups of rooms referred to in **paragraph 2** and between them and other spaces of the building (arranged at the boundary of the common escape routes - corridors, protected clearances, overpressure ventilated buffer rooms, enclosed stairways, etc.). as well as to spaces of different fire risk - according to the heat load densities ( $q$ ) of adjacent spaces and/or the highest heat load densities ( $q$ ) of the spaces they separate and/or those of different fire risk from the function), shall have reaction to fire class **A1** or **A2s1d0** and the minimum fire integrity classification of the fire partition fire walls intended to limit the spread of fire (fire protection walls against that limit the spread within fire compartments (**REI/EI**), according to the classification of the building/fire compartment in fire stability level **I** specified in Table 2, **item No. 5** (if the heat load density in adjacent spaces does not generate higher performance).

(4) Premises of the same type used by persons who cannot evacuate themselves located in high-rise health buildings [hospital or hospital-like buildings - hospitals, maternity wards, polyclinics, medical stations, dispensaries, multi-purpose medical and health centres, clinics and outpatient medical units similar to polyclinics, medical diagnostic and treatment centres, nursing homes or homes for the elderly and disabled, hospices for the mentally retarded, sanatoriums, etc.]) constituted in groups of open rooms are not allowed, with the exceptions specified. Low-risk premises with the same destination included in the health function which are not used by persons who cannot evacuate themselves, they may be formed in open space groupings.

(5) Sleeping or hospitalization rooms (wards, reserves, medical offices, etc.), with the exception of those requiring permanent supervision (ATI, etc.) cannot be formed in open space type groupings, they must be delimited from each other by a minimum (if the function or heat load density of adjacent spaces does not generate higher performance) of non-load-bearing interior partitions with the role of limiting the spread of fire **EI/REI 60** according to the classification of the building/fire compartment in level **I** of stability.

(6) Operating chambers together with their collateral destinations (washers, hand stores of specific medical instrumentation, etc.); and premises requiring permanent surveillance (ATI - Anaesthesia and intensive care) and advisable at (UPU- Emergency unit, etc.) may form each in the open space grouping. They also require the provision of fire resistant doors (sliding) **EI<sub>2</sub> 60-C5S<sub>200</sub>**.

(7) The groupings of open rooms referred to in the preceding paragraphs shall have at least two separate and independent escape routes so arranged and constructed that they can be easily accessible to users. The evacuation routes of users shall comply with the composition conditions laid down in the regulations and the standard discharge lengths.

#### **4.1.4. CONSTRUCTIONAL ARRANGEMENTS OF BUILDING ELEMENTS**

**Article 4.1.4.1. (1)** In high buildings, walls, floors and roofs shall be made of construction products of the reaction to fire class **A1** or **A2-s1d0**.

(2) Construction products used for external finishing, including thermal insulation or cladding of perimeter closures (external walls of any kind, excluding curtain walls and joinery panels of metal profiles) it shall be the reaction class to fire **A1** or **A2-s1d0**.

(3) Roofs, including terrace roofs, shall be made of materials of reaction to fire class **A1** or **A2-s1d0** (thermal insulation mounted on **A1** or **A2-s1d0** substrate), with the exception of waterproofing and cladding, which may be of reaction to fire class **C-s1d0** or better.

(4) The total thermal load density (q) resulting from building materials and elements, finishes, furniture and other housed materials in rooms is recommended not to exceed **840 MJ/m<sup>2</sup>**.

**Article 4.1.4.2. (1)** Perimeter closures of raised buildings shall be designed and carried out in such a way as to ensure that the spread of fire from one level to the next is limited, as required by the provisions of **Article 2.3.6.1.2.** and **Article 2.3.6.1.3.** in order to delay the propagation of fires between construction levels outside perimeter closure (on facades), and for the delay of fire propagation through the interior of the construction, the gaps between the floor and the curtain wall shall be sealed by systems having the same fire resistance in accordance with the general provisions, but at least **EI 90**.

(2) To limit the spread of fire from one level to another outside the construction (on the facade), curtain walls used in raised buildings shall meet the requirements of sub-chapter **2.4.7.1.1.** relating to high buildings.

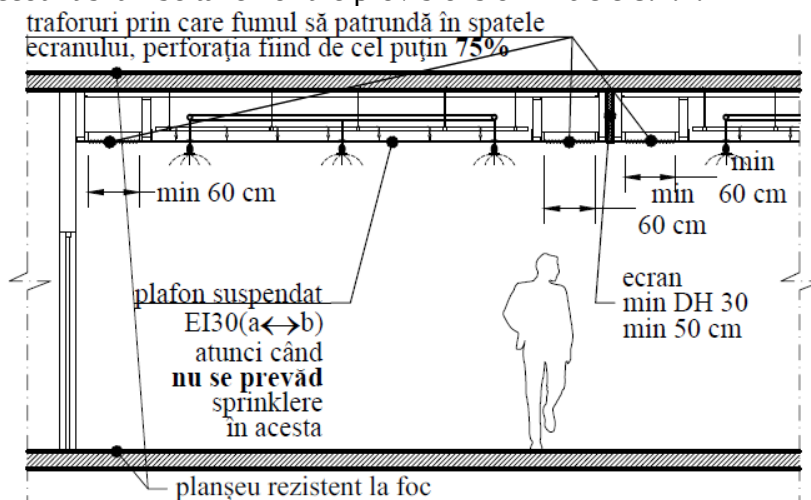
(3) In high buildings, at least to a height of **28 m** from the surrounding terrain or the road, outside the curtain walls, the fire response formations may enter the building shall be marked separately.

**Article 4.1.4.3. (1)** Ceilings with a continuous or discontinuous/modular surface, of perforated, lamellar, honeycomb or grid type (both solid and non-solid) in high-rise buildings shall be made of materials classified in reaction to fire class **A1** or **A2-s1d0**. In addition, full (self-



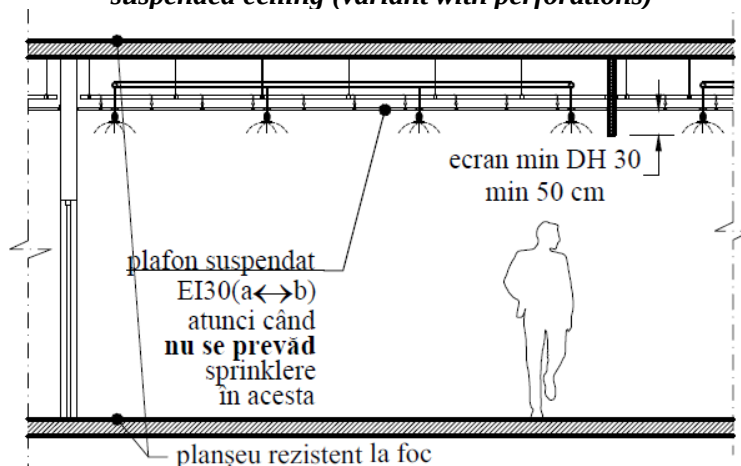
supporting or suspended) ceilings (with continuous surface) will be fire-resistant **EI 30 (a ← b)**. Ceilings with a discontinuous/modular surface of the perforated, lamellar, honeycomb or grill type shall have fire-resistant suspension elements and assemblies **R 30**.

(2) In the case of suspended full ceilings (with continuous closed surface), the continuity of the space between the suspended ceiling and the load-bearing floor shall be interrupted by continuous diaphragms not less than **DH 30**, arranged not more than **30 m** apart in two perpendicular directions, where the space between the suspended ceiling and the load-bearing floor **is not equipped** with an automatic sprinkler system. In this case the ceilings (self-supporting or suspended) solid (with continuous surface) will be fire resistant **EI 30 (a ↔ b)**, according to Figure 70. In all cases, account shall be taken of the provisions of **Article 8.1.2**.



traforuri prin care fumul să pătrundă în spatele ecranului, perforația fiind de cel puțin 75%	perforations through which smoke can penetrate behind the screen, the perforation being at least 75%.
min 60 cm	min. 60 cm
plafon suspendat EI30(a↔b) atunci când <b>nu se prevăd</b> sprinklere în acesta	suspended ceiling EI30 (a ↔ b) when sprinklers are <b>not foreseen</b>
ecran min DH 30 min 50 cm	min DH screen 30 min 50 cm
planșeu rezistent la foc	fire resistant floor

**Variant a) interruption with continuous diaphragms DH 30, min 50 cm not exceeding the height of the suspended ceiling (variant with perforations)**



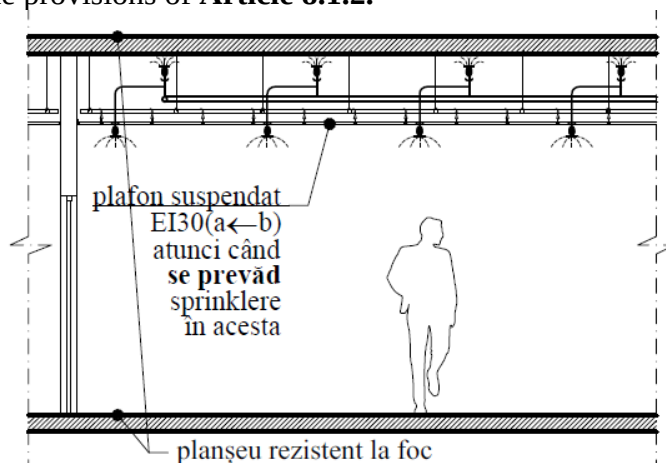
plafon suspendat EI30(a↔b) atunci când <b>nu se prevăd</b> sprinklere în acesta	suspended ceiling EI30 (a ↔ b) when sprinklers are <b>not foreseen</b>
ecran min DH 30 min 50 cm	min DH screen 30 min 50 cm

**Variant b) interruption with continuous diaphragms DH 30 exceeding the height of the suspended ceiling by at least 50 cm (variant without perforations)**

**Figure 70 - Diaphragm interrupting of ceilings with continuous or discontinuous / modular**

**surface in high-rise buildings (when the space between the suspended ceiling and the load-bearing floor is not equipped with an automatic sprinkler system according to SR EN 12845)**

(3) In the case of full ceilings (with the continuous closed surface) suspended, the continuity of the space between the suspended roof and the stress floor shall not be interrupted by continuous diaphragms when the space between the suspended roof and the strength floor **is equipped** with automatic sprinkler extinguishing system. In this case the ceilings (self-supporting or suspended) full (continuous surface) will be fire-resistant **EI 30 (a ← b)**, according to Figure 71. In all cases, account shall be taken of the provisions of **Article 8.1.2**.



plafon suspendat EI30(a ↔ b) atunci când <b>se prevăd</b> sprinklere în acesta	suspended ceiling EI30 (a ↔ b) where sprinklers <b>are provided</b> or
planșeu rezistent la foc	fire resistant floor

**Figure 71 - Ceilings with continuous or discontinuous/modular surface in high-rise buildings where diaphragm interruption is not required (when the space between the suspended ceiling and the load-bearing floor is equipped with automatic sprinkler system according to SR EN 12845)**

**Article 4.1.4.4. (1)** The interior finishes of walls, ceilings and floor coverings of rooms (with the exception of the common functional circulation and evacuation of users) in high buildings shall be the minimum reaction to fire class **B-s1d0**, i.e. minimum **B<sub>FL</sub>-s1**.

(2) In open-plan rooms and spaces (working spaces - for the administrative function), fire reaction class finishes of minimum **B-s2d0** made of foils with a maximum thickness of **0.5 cm**, glued on **A1** or **A2-s1d0** backing and minimum **B<sub>FL</sub>-s1** carpet, with a maximum thickness of **2 cm**, are also allowed, mounted directly or on an impact sound-insulating/vibration dampening layer **A1** or **A2-s1d0**, which are glued or loose-fitted to the backing **A1** or **A2-s1d0**, where open-space rooms are bounded by escape corridors with fire resisting walls to overpressure-ventilated buffer spaces at escape stairways.

(3) In open-plan rooms and spaces (working spaces - for the administrative function), fire reaction class finishes of minimum **B-s1d0** made of foils with a maximum thickness of **0.5 cm**, glued on **A1** or **A2-s1d0** backing and minimum **B<sub>FL</sub>-s1** carpet, with a maximum thickness of **2 cm**, are also allowed, mounted directly or on an impact sound insulating/vibration dampening layer **A1** or **A2-s1d0**, which shall be bonded to the backing **A1** or **A2-s1d0** when the open-space (working - for administrative function) rooms are with direct access to overpressure ventilated protected buffer rooms at the escape stairs.

(4) Raised floor coverings used in rooms shall be carried out in accordance with **Article 2.4.5.4**.

(5) Indoor heat and noise treatments and insulations used in rooms must be the reaction to fire class **A1** or **A2-s1d0**, that is to say **A1<sub>FL</sub>** or **A2<sub>FL</sub>-s1**.

**Article 4.1.4.5. (1)** Vertical garbage cans for installations shall be separated from the rest of the high-rise building by walls of reaction to fire class **A1, A2s1d0** with minimum fire resistance **EI/REI 45**. Hatches and manholes in vertical garbage cans shall be made of **A1, A2s1d0** materials with a minimum fire resistance of **EI 30** and shall not be located in escape stairwells. In this case the vertical garbage cans are sealed around and inside (where technically justified) the ducts and around the cables when passing through the floor slabs, with non-combustible materials having the same fire resistance as the pierced element.

**(2)** Where the sealing of ducts and cables in vertical garbage cans in front of floors is not possible or technically justified, the shaft walls shall be of reaction to fire class **A1, A2s1d0** with a minimum fire resistance of **EI/REI 90** and their doors or manholes shall be made of **A1, A2s1d0** materials with a minimum fire resistance of **EI 60** and shall not be located in escape stairwells.

**Article 4.1.4.6.** Vertical garbage cans shall be separated when passing through floors bounding fire compartments with elements and materials of reaction to fire class **A1, A2s1d0** which will provide the same fire resistance as the pierced floor, and where separation is not possible or technically justified, the shaft walls shall be of materials **A1, A2s1d0** minimum **EI/REI180** and their access doors (hatches) shall be of materials **A1, A2s1d0** minimum **EI90**.

**Article 4.1.4.7.** In high-rise multi-family dwellings, the walls and floors separating the dwelling units from the common functional circulation and evacuation routes of the users shall comply with the provisions of **Art. 4.1.5.2.** and **Art. 4.1.5.3.** and the specific Table 91 and Table 92 of the Rules.

**Article 4.1.4.8. (1)** Storage rooms with a heat load density above **420 MJ/m<sup>2</sup>** is separated from the rest of the tall building with fire resistant walls and fire resistant floors, fire reaction class **A1 or A2-s1d0**, respectively functional gaps as specified in Table 90. Those with a high or very high fire risk shall be provided with smoke and hot gas exhaust systems by natural-organised draught or by mechanical ventilation, in accordance with the provisions of the standard and specific technical regulations.

**Table90: Minimum conditions for separation of storage rooms with heat load density  $\geq 420$  MJ/m<sup>2</sup> in elevated civilian buildings**

<b>STORAGE ROOMS</b>				
	<b>MIDDLE RISK</b>	<b>HIGH RISK</b>	<b>VERY HIGH RISK</b>	
	$420 \text{ MJ/m}^2 \leq q < 840 \text{ MJ/m}^2$	$840 \text{ MJ/m}^2 \leq q < 1680 \text{ MJ/m}^2$	$1680 \text{ MJ/m}^2 \leq q < 2,940 \text{ MJ/m}^2$	$\geq 2,940 \text{ W/m}^2$
$\leq 36 \text{ m}^2$				
<b>Walls</b>	<b>EI/REI 120</b>	<b>EI/REI 180</b>	<b>EI/REI 180</b>	<b>Not permitted</b>
<b>Floor slabs</b>	<b>REI 120</b>	<b>REI 120</b>	<b>REI 180</b>	
<b>Fire-resistant and smoke-tight doors</b>	buffer rooms 2 x <b>EI<sub>2</sub>30-C3S<sub>200</sub></b>	protected buffers 2 x <b>EI<sub>2</sub>45-C3S<sub>200</sub></b>	protected buffers 2 x <b>EI<sub>2</sub>60-C3S<sub>200</sub></b>	
$> 36 \text{ m}^2$				
<b>Walls</b>	<b>EI/REI 180</b>	<b>EI/REI 180</b>	<b>EI/REI 240</b>	<b>Not permitted</b>
<b>Floor slabs</b>	<b>REI 120</b>	<b>REI 180</b>	<b>REI 180</b>	
<b>Fire-resistant and smoke-tight doors</b>	buffer rooms 2 x <b>EI<sub>2</sub>45-C3S<sub>200</sub></b>	protected buffers 2 x <b>EI<sub>2</sub>60-C3S<sub>200</sub></b>	protected buffers 2 x <b>EI<sub>2</sub>60-C3S<sub>200</sub></b>	
<b>Remarks</b>	<p>Rooms with very high fire risk (except those with volumetric explosion hazard/risk), with heat load density <math>1,680 \text{ MJ/m}^2 \leq q &lt; 2,940 \text{ MJ/m}^2</math>, with surface area <math>\leq 36 \text{ m}^2</math> are only allowed in a separate compartment of the tall building, adjoining, with normal height regime or only in the lower half of the tall building</p> <p>Rooms with very high fire risk (except those with volumetric explosion hazard/risk), with heat load density <math>1,680 \text{ MJ/m}^2 \leq q &lt; 2,940 \text{ MJ/m}^2</math>, with a surface area <math>&gt; 36 \text{ m}^2</math> are allowed only in a separate compartment of the high-rise building, adjoining, with normal height regime or in an area of maximum <math>400 \text{ m}^2</math>, only in the lower half of the high-rise building.</p> <p>Rooms with volumetric explosion hazard/risk are not allowed in high-rise building compartments, except as permitted by other specific regulations. For permitted activities with the risk of volumetric explosion arranged technically or functionally at all levels of construction (including the terrace of the last level of high civil engineering), it is mandatory to ensure appropriate partitioning measures to other areas and functions with elements resistant to fire and volumetric explosion, in accordance with the applicable legislation and technical regulations (e.g. thermal power stations located on buildings). In high civil engineering, handling, processing or storage of materials and substances at risk of volumetric explosion shall not be permitted, as well as the location of workshops where such materials are used, with the exception of those established by specific regulations (laboratories, pharmacies, hospitals, etc.).</p> <p>Storage rooms with a heat load density of more than <math>210 \text{ MJ/m}^2</math> and less than <math>420 \text{ MJ/m}^2</math> will have <b>EI/REI 60</b> walls and their doors shall be <b>EI<sub>2</sub>30-C3S<sub>200</sub></b>.</p> <p>Storage rooms with a floor area greater than <math>36 \text{ m}^2</math> and a heat load greater than <math>105 \text{ MJ/m}^2</math> shall be provided with exhaust systems for smoke and hot gases by natural-organised draught or by mechanical ventilation, according to the provisions of the standard and specific technical regulations. The total useful/aerodynamic area of the free area of devices with automatic smoke discharge aperture in the event of organised natural fire, shall be at least 1 % from the surface of the floor coverings. When smoke exhaust is provided by mechanical ventilation, the provisions of the Rule and/or technical regulations shall be complied with.</p>			

**Article 4.1.4.9. (1)** The partitioning elements between car parking spaces and raised buildings to which they adjoin or into which they are incorporated shall be fire reaction class **A1** or

**A2-s1d0**, fire resistant to a minimum of **EI/REI 240** for walls and a minimum of **REI 180** for floors.

(2) Functional communication gaps are permitted in these bulkheads if they are protected by overpressure ventilated protected buffer rooms equipped with fire resistant and smoke-tight doors **EI<sub>2</sub> 90-C5S<sub>200</sub>** and provided with overpressure or smoke and hot gas exhaust systems in case of fire.

**Article 4.1.4.10. (1)** Lifts intended for the functional movement of persons, goods, monte-charge type and other material vertical transport systems in raised buildings will be built in accordance with specific legislation and shall have their own lift wells separated from the rest of the construction by minimum fire-resistant walls. **EI/REI 120**, for lifts intended for the functional movement of persons that is to say **EI/REI 180** for other types of lifts or systems and, where appropriate, minimum fire-resistant floors **REI 120** reaction class to fire **A1** or **A2-s1d0**. In the walls of lift wells, only functional gaps at building levels (landing doors) are permitted.

(2) A maximum of three lift cars may be placed in a shaft for the functional movement of persons.

**Article 4.1.4.11. (1)** On the upper floors of the high-rise building, access to lifts intended for the functional movement of persons shall be provided via **EI 90** fire-resistant landing (lift) doors;

(2) On the underground levels of the high-rise building, access to lifts intended for the functional movement of persons shall be provided by means of overpressure-ventilated buffer rooms fitted with **E30-C5S<sub>200</sub>** fire and smoke-tight doors to the horizontal common circulation and **EI90** fire-resistant doors to lift doors; in this case the overpressure ventilated buffer room shall be provided with walls of reaction to fire class **A1** or **A2-s1d0**, with a minimum fire resistance **EI/REI 90**.

(3) Exceptions are low fire risk basements, which are separated in the same way as above ground levels.

**Article 4.1.4.12. (1)** On the upper levels of the high-rise building, access to goods lifts, freight lifts and other vertical material handling systems shall be provided by means of overpressure-ventilated buffer rooms with **EI<sub>2</sub>60-C5S<sub>200</sub>** fire and smoke-tight doors to the horizontal common circulation and **EI90** fire doors to the lift landing doors; the overpressure ventilated buffer room shall be provided with walls of reaction to fire class **A1** or **A2-s1d0**, fire resistance minimum **EI/REI 90**.

(2) On the underground levels of the high-rise building, access to lifts, freight lifts and other vertical material handling systems is provided by means of overpressure ventilated buffer rooms with **E90-C5S<sub>200</sub>** fire and smoke-tight doors to the horizontal common circulation and **EI90** fire doors to the lift doors; the overpressure ventilated buffer room shall be provided with walls of reaction to fire class **A1** or **A2-s1d0**, fire resistance minimum **EI/REI 90**.

(3) If at least one station starts in a space requiring doors with higher fire resistance performance characteristics (generated by operation or thermal load density), the lifts shall comply (at least on that level, as appropriate) with doors and walls at the buffer room in accordance with those conditions.

(4) It is recommended that the lift shafts of basements of high-rise buildings be separated from the lifts of the upper floors.

**Article 4.1.4.13. (1)** In high civil buildings, lifts provided for the functional movement of trolley persons or disabled persons which may also be used for their assisted evacuation in the event of fire, where they comply simultaneously with the following conditions:

**a)** are provided with their own shaft, equipped with overpressure installation, separated from the rest of the construction with walls of reaction to fire class **A1** or **A2-s1d0** fire resistant minimum **EI/REI 120** and floors of reaction to fire class **A1** or **A2-s1d0** fire resistant minimum **REI 90**;

- b) have ensured operation for a minimum **90** minutes after the outbreak of the fire;
- c) comply with the provisions of **Article 3.1.4.4 (3) points (c), (d), (e), (f) and (g)**.

(2) On the upper floors of high-rise buildings, access to lifts intended for the functional movement of wheelchair users or disabled persons who can be used and for their assisted evacuation in the event of fire shall be provided by means of overpressure-ventilated buffer rooms with fire-resistant and smoke-tight doors **EI<sub>2</sub>30-C5S<sub>200</sub>** to the horizontal common circulation and fire-resistant doors **EI90** to the lift doors; in this case the overpressure ventilated buffer room shall be provided with walls of reaction to fire class A1 or A2-s1d0, with a minimum fire resistance **EI/REI 90**.

(3) On the underground levels of high-rise buildings, access to lifts intended for the functional movement of persons with wheelchairs or disabled persons who can be used and for their assisted evacuation in the event of fire shall be provided by means of overpressure-ventilated buffer rooms with fire-resistant and smoke-tight doors **EI<sub>2</sub>60-C5S<sub>200</sub>** to the horizontal common circulation and fire-resistant doors **EI90** at lift doors; in this case the overpressure ventilated buffer room shall be provided with walls of reaction to fire class **A1** or **A2-s1d0**, with a minimum fire resistance **EI/REI 90**.

(4) If the lifts which can also be used for the assisted evacuation of persons with trolley or disabled persons have a two-access cab, all specified gaps shall meet the conditions of **paragraphs 2 and 3**.

(5) Lifts intended for the transport of wheelchair users or disabled persons which can also be used for their assisted evacuation in the event of fire in high-rise civil buildings shall have their controls in corridors or protected landings.

(6) Where access openings to lifts intended for the functional movement of persons and to lifts intended for the transport of sick persons on stretchers or trolleys or of disabled persons which can also be used for their assisted evacuation in the event of fire on the upper floors of high-rise buildings open into a ventilated buffer space under common overpressure, all doors to lifts shall be of **EI90** minimum and the overpressure ventilated buffer shall be provided with **EI<sub>2</sub>30-C5S<sub>200</sub>** fire resisting and smoke-tight doors and walls of reaction to fire class **A1** or **A2-s1d0**, fire resistant to **EI/REI 90** minimum. When opening to the underground levels of high-rise buildings in a common overpressure ventilated buffer room, all lift doors shall be minimum **EI90** and the overpressure ventilated buffer room shall be provided with fire resistant and smoke-tight doors **EI<sub>2</sub>60-C5S<sub>200</sub>** and walls reaction to fire class **A1** or **A2-s1d0**, fire resistant **EI/REI 90** minimum.

(7) Where access openings to lifts intended for the functional movement of persons, stairways for the evacuation of persons and lifts intended for the transport of persons in wheelchairs or disabled persons which can also be used for their assisted evacuation in the event of fire on the upper floors of high-rise buildings open into a ventilated buffer room under common overpressure, all lift doors shall be a minimum of **EI90**, the stairwell door shall be a minimum of **EI<sub>2</sub>90-C5S<sub>200</sub>** and the overpressure ventilated buffer shall be provided with fire and smoke-tight doors **EI<sub>2</sub>30-C5S<sub>200</sub>** and walls of reaction to fire class **A1** or **A2-s1d0**, fire resistant to a minimum of **EI/REI 90**. When opening at underground levels of high-rise buildings into a common overpressure ventilated buffer room, all lift doors shall be minimum **EI90**, the stairwell door shall be minimum **EI<sub>2</sub>90-C5S<sub>200</sub>** and the overpressure ventilated buffer room shall be provided with **EI<sub>2</sub>60-C5S<sub>200</sub>** fire and smoke-tight doors and walls of reaction to fire class **A1** or **A2-s1d0**, fire resistant minimum **EI/REI 90**.

(8) Where the functions of high-rise buildings involve the transport of sick persons in wheelchairs or on stretchers, lifts intended for the transport of sick persons in wheelchairs or on stretchers or trolleys or disabled persons which can also be used for their assisted evacuation in the event of fire shall comply with the provisions of the preceding paragraphs (**paragraphs 1 ÷ 7**).

(9) The lifts provided for the transport of people with wheelchairs or patients with wheelchairs, stretchers or people with disabilities that can be used and for their assisted evacuation in case of fire will have the controls in protected corridors or in protected clearances.

**Article 4.1.4.14.** In the event of breakdown or stoppage, emergency lifts in high-rise buildings must be equipped with an access through which trapped firefighters can rescue themselves or with the help of others (for example, the escape hatch that must be provided in the roof of the cabin must be equipped with a portable ladder). In the event of a fire, all cabins must be automatically brought to the ground floor and remain shut down until the building's fire command is cancelled. Exceptions are the lifts for intervention as well as those for evacuating people with wheelchairs or patients with wheelchairs, stretchers or disabled people that will work during the fire (corresponding to the time for which they are equipped), through backup power.

**Article 4.1.4.15. (1)** In tall buildings, it is mandatory to provide at least one fire intervention lift (for firefighters), with easy access from the entrance to the building, made in accordance with the requirements to ensure fire intervention operations and provided with a priority call for firefighters.

**(2)** The fire intervention lift shall be provided with its own well, separated from both the rest of the building and the outside, with fire-resistant walls **REI/EI 120** and, where applicable, minimum fire resistant floors **REI 120** reaction class to fire **A1** or **A2-s1, d0** and access gaps protected by access buffers provided with excess pressure ventilation and fire resistant and smoke tight doors.

**(3)** Access to emergency lifts on the upper floors of high-rise buildings shall be provided by means of overpressure-ventilated buffer rooms with fire-resistant and smoke-tight doors **EI<sub>260</sub>-C5S<sub>200</sub>** to the horizontal common circulation and fire-resistant doors **EI120** to the lift doors and the overpressure-ventilated buffer room shall be provided with walls of reaction to fire class **A1** or **A2-s1d0**, fire-resistant min **EI/REI 120**. Access to emergency lifts on the underground levels of high-rise civil buildings shall be provided by means of overpressure-ventilated buffer rooms fitted with **EI<sub>290</sub>-C5S<sub>200</sub>** fire and smoke-tight doors to the horizontal common circulation and **EI120** fire doors to the lift doors, and the overpressure-ventilated buffer room shall be fitted with walls of reaction to fire class **A1** or **A2-s1d0**, fire resistant minimum **EI/REI 120**.

**(4)** The fire-fighting lift shall comply with the provisions of **Article 3.1.4.8. paragraphs 3 ÷ 8** and the provisions of **Art. 3.1.4.8. paragraphs 11 ÷ 14**.

**(5)** The fire intervention lift shall be positioned within the buildings in such a way that it is provided with access to the outside directly from the outside or through smoke free spaces of the maximum length equivalent to that of the flooded corridor dimensions of the raised building.

**(6)** The intervention lift shall be provided with a priority call for firefighters and shall provide access for fire response to the above-ground and underground levels of the building. In underground car parks with more than **4** levels embedded in high buildings, firefighter lifts for parks shall be different from the firefighter lifts of the above-ground levels.

**(7)** The intervention lift shall be carried out in accordance with the specific technical regulations and shall be operated for time by **120** minutes after the outbreak of the fire.

**(8)** When access by firefighters is made via the same evacuation ladder (of persons) in the calculation of the evacuation flows of persons, it is considered as a downward outlet for their evacuation. It is mandatory that the clear width of ramps and stairwells (measured according to the standard provisions) usable for an escape flow of persons as well as fire brigade access is in this case at least **1.20 m**.

#### **4.1.5. ESCAPE ROUTES FOR USERS IN CASE OF FIRE**

**Article 4.1.5.1. (1)** In high buildings it is mandatory to ensure a minimum of two separate and independent evacuation routes for users.

**(2)** The evacuation routes of users shall comply with the composition conditions laid down in the regulations and the standard discharge lengths.

**Article 4.1.5.2.** The burning behaviour of walls, doors and separation floors of enclosed stairway houses in above-ground civil buildings shall comply with the provisions of Table 91.

**Table91: Fire behaviour of walls, doors and separation floors of enclosed stairway houses in above-ground civil buildings**

Fire stability level	Permitted reaction to fire levels in closed stairways				
	Walls		Floors (separating stairway houses enclosures from the rest of the construction)		Doors
<b>I</b>	<b>EI/REI 180</b>	<b>A1 or A2-s1d0</b>	<b>REI 120</b>	<b>A1 or A2-s1d0</b>	<b>2xEI<sub>2</sub>60-C5S<sub>200</sub> in protected buffer rooms</b>

Note: Lift lobbies of public buildings may communicate freely with public spaces on the level if the fire performance of the lift doors is **EI120**

**Article 4.1.5.3.** The fire performance of walls, doors and floors separating horizontal escape routes (corridors and hallways) in high-rise civil buildings shall comply with Table 92.

**Table92: Fire behaviour of walls, doors and horizontal escape route partitions (corridors and hallways) in civil high-rise buildings**

Fire stability level	Permitted reaction to fire levels in corridors and halls				
	Walls		Floors (separating corridors and halls from the rest of the construction, including their exit paths to the land level or adjacent roads)		Doors (except for stairway houses enclosures)
<b>I</b>	<b>EI/REI 90</b>	<b>A1 or A2-s1d0</b>	<b>REI 120</b>	<b>A1 or A2-s1d0</b>	<b>EI<sub>2</sub> 30 - C5S<sub>200</sub></b>

Note:

In the case of glazed metal profile walls separating corridors and hallways from adjacent rooms, the reaction to fire class is not taken into account.

**Article 4.1.5.4. (1)** At all levels of the elevated above-ground building, each of the user evacuation ladders shall be accessible through the protected buffer room ventilated over pressure, on independent routes and different directions, as well as through standardised discharge lengths.

**(2)** At least one of the escape ladders of the raised building shall have access to the terrace roof.

**Article 4.1.5.5.** When using escalators the provisions of Art. 2.5.6.3.3. of the Rules shall be observed.

**Article 4.1.5.6. (1)** The evacuation routes of users of the high ground buildings shall comply with the evacuation lengths specified in Table 93.

**(2)** The maximum permissible exhaust lengths shall be determined for the escape route travelled from the room door to the nearest entrance door to the ventilated protected buffer room over pressure of the stairway enclosure.

**(3)** If the distance travelled within the room to the door provided in the fire resisting wall (bounding the corridor from the room) is less than the maximum escape length permitted for escape in one direction only, then the length of the two separate and independent escape routes required shall be measured from the room door, and the escape route from the door of the room to the nearest door of entry to the buffer room of the nearest enclosed escape staircase is required to be less than the maximum escape length permitted for two-way escape.

**(4)** If the distance travelled within the room to the door provided in the fire resistant wall (delineation of the corridor from the room) is greater than the maximum length of escape permitted



for evacuation in one direction, then two escape routes within the head are required and the length of the two separate and independent escape routes required shall be measured from the most unfavourable point within the room, the escape route flowing from that point to the nearest entrance door to the buffer room of the nearest stairway enclosure shall be less than the maximum length of discharge permitted for evacuation in two directions.

**Table93: Escape lengths in high above-ground buildings**

Use of the high-rise building	Maximum exhaust length	
	in two different directions	in one direction (flooded corridor)
	m	m
Administrative, education, tourism, health, commerce, worship, collective housing, etc.	35	20

Notes:

a) The exhaust length in one direction (dead-end corridor) also refers to the interior of rooms and living quarters respectively.

b) For crowded rooms in raised buildings, the specific performance requirements for high buildings shall be complied with, and the construction ladders may be used for the evacuation of users, provided that they also meet the composition and dimensioning requirements for crowded rooms.

c) Crowded rooms in raised buildings situated in the doors of high buildings up to and including + 28 m shall comply with the provisions on performance specific to high buildings, and the use of high construction ladders for the evacuation of users is permitted, provided that they also meet the requirements for composition and dimensioning for crowded rooms. Crowded rooms in raised buildings arranged in functionally and constructively separated fire compartments from the rest of the raised building, at any rate within the volume of the raised buildings, which have their own stairways (provided they also meet the conditions for the composition and dimensioning of crowded rooms) for evacuation of all users of the crowded rooms, do not give rise to the fulfilment of the composition and dimensioning conditions for crowded rooms of the other escape ladders of the raised building.

**Article 4.1.5.7.** The standard number of users per evacuation flow unit ( $U_f$ ) in high rise buildings is **70 users**. The standard number of users per evacuation flow unit ( $U_f$ ) in high rise buildings for people who cannot evacuate themselves (defined according to the terminology) is **50 users**.

**Article 4.1.5.8. (1)** At the above ground levels of the raised building, access to the enclosed escape ladders shall only be permitted through protected buffer rooms ventilated under excess pressure, in accordance with the regulatory provisions.

**(2)** Protected overpressure ventilated buffer rooms shall have minimum **EI/REI 60** fire resistant walls and **REI 60** ceilings, reaction to fire class **A1 or A2-s1d0** and protected circulation gaps with fire resistant and smoke tight doors **EI<sub>2</sub>60-C5S<sub>200</sub>**.

**(3)** Doors in buffer rooms to escape stairwells shall be fitted with anti-panic bars and shall open for the purpose of evacuation regardless of the number of persons.

**(4)** Escape doors starting outside the construction and any other doors along the common escape movement route shall be fitted with anti-panic bars.

**Article 4.1.5.9. (1)** On the underground levels of high-rise buildings, users' access to enclosed escape staircases shall be provided only by means of protected, overpressure-ventilated buffer rooms with minimum **EI/REI 90** fire-resistant walls, **REI 90** floors, reaction to fire class **A1 or A2-s1d0** and **EI<sub>2</sub> 90-C5S<sub>200</sub>** fire and smoke-tight doors.

**(2)** Doors in buffer rooms shall be fitted with anti-panic bars and shall open in the direction of evacuation regardless of the number of persons.

**(3)** Escape doors starting outside the construction and any other doors along the common escape movement route shall be fitted with anti-panic bars.

**Article 4.1.5.10. (1)** Stair landings of closed staircases on underground levels of high-rise buildings shall be separated from stair landings of above-ground levels by minimum **EI/REI 120** fire resisting walls and **REI 120** floor boards, reaction to fire class **A1** or **A2-s1d0**.

**(2)** Functional communication between the underground staircase landings and the staircase landings above ground may be provided by a fire-resistant and smoke-tight door **EI<sub>2</sub> 90-C5S<sub>200</sub>**, located on the ground floor or intermediate landing between the ground floor and the first basement level, opening in the direction of escape.

**(3)** If there is no communication between the underground and the above-ground ramp, the exit gap in the ground floor hallway of the underground ramp shall be protected by a fire-resistant and smoke-tight door with a minimum **EI<sub>2</sub> 90-C5S<sub>200</sub>** opening in the direction of escape.

**Article 4.1.5.11. (1)** The interior finishes of walls, ceilings and floors of common paths for the functional circulation and evacuation of users of high buildings shall be the reaction to fire class **A1** or **A2-s1d0**, that is to say **A1<sub>orFL</sub>A2<sub>FL</sub>-s1**.

**(2)** On the common horizontal functional circulation and evacuation routes of users (corridors, hallways), finishes of reaction to fire class **B-s1d0** minimum, made of foils with a maximum thickness of **0.5 cm**, glued on **A1** or **A2-s1d0** substrate, and carpet, **B<sub>FL</sub>-s1** minimum, with a maximum thickness of **2 cm**, mounted directly or on an impact sound insulating/vibration damping layer, glued or loose laid on **A1** or **A2-s1d0** substrate, are also allowed.

**(3)** Elevated floors shall be carried out in accordance with **Article 2.4.5.4**.

**(4)** Internal heat and noise treatments and insulations used on common circulation routes shall be the reaction to fire class **A1** or **A2-s1d0**, that is to say **A1<sub>FL</sub>or A2<sub>FL</sub>- S1**.

**Article 4.1.5.12. (1)** Horizontal common corridors (corridors, hallways) which do not have direct windows to the outside through which smoke can be evacuated (located in facades, less than 30 m from any point in the facades), shall be provided with smoke and hot gas evacuation systems in case of fire with natural-organised draught or by mechanical ventilation or shall be provided with SPD differential pressure systems, as specified in the relevant standards and technical regulations.

**(2)** The evacuation of smoke and hot gases in the event of fire from enclosed stairwells and their buffer rooms shall be provided by an organised natural draught or they shall be pressurised. The evacuation of smoke and hot gases in the event of fire from enclosed underground stairway houses and their buffer rooms shall only be provided by organised natural draught, or shall be placed in excess pressure.

**(3)** The evacuation of smoke and hot gases in the event of fire from stairway houses and horizontal underground common circulations shall be ensured separately from those of the above-ground levels.

#### **4.1.6. FIRE ACCESS, RESPONSE and RESCUE CONDITIONS**

**Article 4.1.6.1. (1)** In high-rise buildings, access and escape routes for fire-fighting vehicles shall be provided on at least two (2) adjoining sides and at least **50%** of the perimeter of the exterior walls.

**(2)** In accordance with the maximum simultaneous capacity of the high-rise building, the provisions of **Article 2.6.7. paragraph 1, 2 and 3**. For a maximum simultaneous capacity of more than **3,500** persons, **Art. 2.6.5. paragraph 3**.

#### **4.1.7. EQUIPPING BUILDINGS WITH FIRE-FIGHTING INSTALLATIONS AND APPLIANCES**

**Article 4.1.7.1. (1)** Raised buildings shall be equipped with fire-fighting facilities and means, as well as fire detection, signalling and alarm installations, in accordance with the provisions of the specialised technical regulations.

(2) High buildings shall be equipped with extinguishers, providing a portable extinguisher with minimum extinguishing performance **21A** and **113B** for a built-up area of up to **250 m<sup>2</sup>**, but at least two extinguishers on each level of the building.

## **SECTION II**

### **4.2. Very high above-ground civilian buildings**

#### **4.2.1. COMMON BUILDING PERFORMANCE CONDITIONS (FIRE RISK, FIRE STABILITY LEVEL OF THE BUILDING)**

**Article 4.2.1.1. (1)** Very high above-ground civilian buildings, including those portions of them with heights below the limit for classification as very tall buildings, shall have Level I fire stability.

(2) The fire stability level of very high buildings shall be determined in accordance with the provisions of **Article 2.1.3.2.** and Table 2.

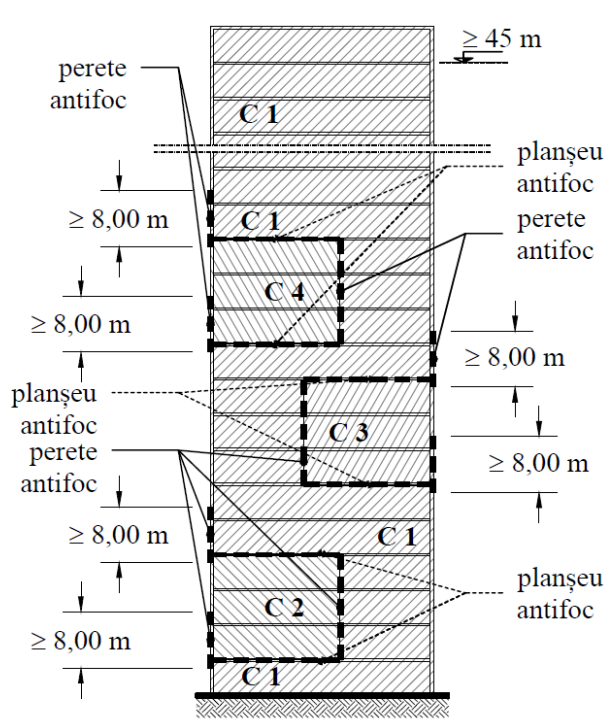
#### **4.2.2. LOCATION AND COMPLIANCE OF BUILDINGS**

**Article 4.2.2.1. (1)** Merging with each other or with other very high civil engineering structures within the same fire compartment shall be prohibited.

(2) The minimum fire safety distances to be ensured between very high above-ground civil buildings and other structures are set in accordance with the rules, in **Article 2.2.1.2.** and Table 4.

(3) Very high above-ground civilian buildings may be subdivided into their full height with fire bulkheads within the built area (**Ba**) not exceeding **3,500 m<sup>2</sup>** in any number of fire compartments. In a fire compartment of the very high building with the built area (**Ba**) not exceeding **3,500 m<sup>2</sup>** a maximum of three volumetric portions may be provided (as shown in Figure 9, variant a), with the total area developed (**Da**) of each volume portion not exceeding **3,500 m<sup>2</sup>** (without possibility of increment), portions consisting of one to three successively constructed levels delimited by fire floors and, where appropriate, fire bulkheads by the fire compartment into which they are inserted.

(4) Where compartments **no** are equipped with an automatic sprinkler water fire-extinguishing system but equipped with a fire detection, signalling and alarm system with full cover, within a fire compartment with the built area (**Ba**) not exceeding **3,500 m<sup>2</sup>** only one volumetric portion of it (as shown in Figure 8 Variant a) may be provided, with the total area developed (**Da**) not exceeding **2,500 m<sup>2</sup>** (without the possibility of increment), a portion consisting of one to three successively constructed levels delimited by fire decks and, where appropriate, fire walls.



**Legend:**  
**C1, C2, C3, C4 – separate fire compartments, level II fire stability**  
 Fire compartment areas:  
 C1\*Compartment (very high building with any operation except dwelling) - A constructed  $\leq 3,500 \text{ m}^2$   
 C2 Compartment (volumetric compartment in very high building) – Developed area  $\leq 3,500 \text{ m}^2$   
 C3 Compartment (volumetric compartment in very high building) – Developed area  $\leq 3,500 \text{ m}^2$   
 Compartment C3 (high building volumetric compartment) – Developed area  $\leq 3,500 \text{ m}^2$   
 Note\*: Where the C1 compartment is additionally equipped with automatic sprinkler fire extinguishing system  
 Its built area can be  $\leq 4,350 \text{ m}^2$

perete antifoc	fire wall
planșeu antifoc	fire floor

**Figure 72 - Fire partition and fire compartment areas in very high-rise civil above-ground fire compartments and buildings**

(4) The built-up areas related to buildings and fire compartments throughout their height, standardized at  $3,500 \text{ m}^2$ , can be increased by 25% when they are equipped with water fire extinguishing installations, sprinkler type additional to the provisions of the profile standard.

**Article 4.2.2.2. (1)** The fireproof walls that separate fire compartments will be **EI-M 180/REI 180** fire reaction class **A1** and, where applicable, the floors that separate fire compartments will be REI, with the fire resistance established according to the thermal load density (q) from the adjacent rooms according to the provisions of **Article 2.3.1.2.** and **Table 5** but minimum **180 minutes (REI 180)**.

(2) Functional communication can be provided through gaps in fire-resistant walls **EI-M 180/REI 180** separating fire compartments (fire bulkheads) through protected buffers, ventilated over pressure and equipped with fire resistant and smoke tight doors as a minimum **EI<sub>2</sub> 90-C5S<sub>200</sub>**.

**4.2.3. LIMITING THE SPREAD OF FIRES**

**Article 4.2.3.1.** In very high civilian buildings it is not recommended to place rooms with high fire risks and, where technically justified, they shall be provided in separate areas and only with appropriate protective measures (partitioning from the rest of the building with vertical and horizontal fire resistant elements, constructed and dimensioned in accordance with the fire risk and heat load density (q), equipment with automatic signalling and fire-fighting systems, etc.).

**Article 4.2.3.2.** Rooms with very high fire risks shall not be permitted in very high above-ground civilian buildings. Rooms with high fire risks shall not be permitted in very high above-ground civil buildings, with the exception of those provided for in **Article 4.12.4.8.** and Table 94.

**Article 4.2.3.3. (1)** In very high above-ground civil constructions, the separation of the rooms from the rest of the construction is ensured according to the provisions regarding the common performances as well as the specific ones specified in this chapter, and when the norm does not provide, through non-load-bearing internal dividing walls with the role of limiting the spread of fire and / or through partition walls according to the provisions of **Art. 2.1.3.2.** and Table 2, depending on their height regime.

**Article 4.2.3.4. (1)** When separating groups of open-space office rooms from other rooms with a standard floor area according to **paragraph 2**, with low fire risk and the same use (own or complementary / offices and functional circulation delimited by partitions, panels or functional partitions of reaction to fire class **A1, A2-s1,d0**), provision shall be made for at least sector separating walls to limit the spread of fire to adjacent spaces (except those to escape routes which comply with the specific provisions and those to rooms with a higher risk due to the density of the thermal load in adjacent rooms), which shall be of reaction to fire class **A1, A2-s1,d0** minimum:

- a)** **EI/REI 120** fitted with fire resistant and smoke tight doors **EI<sub>2</sub>60-C5S<sub>200</sub>** in very tall civil constructions with fire stability level **I** with height **h**, **45m ≤ h < 75m**;
- b)** **EI/REI 180** fitted with fire resistant and smoke tight doors **EI<sub>2</sub>90-C5S<sub>200</sub>** in very high civil engineering with fire stability level **I** of height **h**, **h ≥ 75m**

**(2)** Groups of open space office rooms, delineated within the grouping by opaque panels or glazed panels, fixed or mobile (reaction to fire class **A1, A2-s1, d0**, except for non-substantial components, glazing (glass) elements and glazing fittings) used as functional separation and/or sound insulation or functional internal walls or partitions (reaction to fire class **A1, A2-s1, d0**) shall be permitted within the limits of the following areas built within very high administrative buildings:

- a)** unlimited, provided that the built-up area of the groupings of office rooms open to it is not more than **75%** from that of the built-up area of that level for administrative constructions falling within the level of **I** fire safety equipment with height **h**, **45m ≤ h < 75 m** and no groupings with the conditions laid down in **paragraph 1 letter a)** do not go beyond **2,500 m<sup>2</sup>**;
- b)** unlimited, provided that the built-up area of the groupings of office rooms open is maximum **75%** from that of the built-up area of that level for administrative constructions falling within the level of **I** fire safety equipment with height **h**, **75 m ≤ h < 125 m** and a grouping with the conditions laid down in **paragraph 1 letter b)** do not go beyond **1,875 m<sup>2</sup>**;
- c)** unlimited, provided that the built-up area of the groupings of office rooms open is maximum **75%** from that of the built-up area of that level for administrative constructions falling within the level of **I** fire safety equipment with height **h**, **h ≥ 125m** and a grouping provided for with the conditions laid down in **paragraph 1 letter b)** do not go beyond **1.250 m<sup>2</sup>**.

**(3)** The groupings of open-plan office spaces referred to in the preceding paragraphs shall be provided with a minimum of two separate and independent escape routes so arranged and constructed as to be readily accessible to users for very tall administrative buildings of administrative (office) fire safety level **I**. The evacuation routes of users shall comply with the composition conditions laid down in the regulations and the standard discharge lengths.

**(4)** The groupings of open office rooms will also comply with the requirements set out in **Article 2.4.3.2. paragraph 4** and in **Article 2.5.14.1.**

**Article 4.2.3.5. (1)** Premises for sale with a heat load density  $q$  of less than **840 MJ/m<sup>2</sup>** shall be separated from ancillary rooms which are not accessible to purchasers (social or functional annexes, offices, etc.) by fire-resistant walls of at least **EI/REI 120** and, where appropriate, **REI 120** fire-resistant floorboards, and the functional circulation and escape openings in these walls shall be protected by fire-resistant and smoke-tight enclosures of at least **EI<sub>2</sub>60-C5S<sub>200</sub>**. Enclosed rooms which are not accessible to purchasers and sales premises shall be separated in the same way.

Open space groupings consisting of groupings of high, medium or low fire risk spaces with a commercial function in very tall buildings are not permitted.

(2) Premises for sale with a heat load density  $q$  greater than or equal to **840 MJ/m<sup>2</sup>** (high fire risk) shall only be permitted if the conditions in Table 94 (boundary with walls, floors and doors or buffers ventilated in excess pressure, exceptions being excluded). Sales areas with density of heat charge above **1,680 MJ/m<sup>2</sup>** are not allowed.

(3) For sales premises with a heat load density  $q$  of less than **840 MJ/m<sup>2</sup>** in very tall buildings, it is permissible to replace fire resisting walls between sales spaces to horizontal common circulation (corridors and hallways) fitted with independent mechanical smoke and hot gas exhaust systems with continuous **DH 120** screens, located at the edge of the resistance elements to horizontal common circulation, having a height equal to that of the smoke tank, but not less than **1 m** (smoke from the smoke tank must not extend to adjacent smoke areas in the circulation).

(4) Fire resisting walls between high fire risk sales spaces and common vertical escape circulation (corridors and hallways) in very tall civil buildings shall comply with Table 96, but with minimum **EI/REI 180** and, where appropriate, with minimum **REI 120** fire resisting floorboards, and functional and escape circulation gaps in these walls shall be protected with minimum **EI<sub>2</sub>90-C5S<sub>m</sub>** fire resisting closure elements.

**Article 4.2.3.6. (1)** When separating groupings of open-plan rooms which are not used by persons who cannot evacuate themselves (defined according to the terminology) (with the exception of administrative areas and staff changing rooms grouped with toilets included in the health function) from other rooms with a maximum standard surface area, with a low fire risk and the same use (own or complementary / functional areas and circulation delimited by partitions, panels or internal partitions functionally of reaction to fire class **A1, A2-s1, d0**), at least partition walls shall be provided to limit the spread of fire to adjacent spaces (except those to escape routes complying with specific provisions and those to rooms with a higher risk due to the density of the thermal load in adjacent rooms), which shall be of reaction to fire class **A1, A2-s1, d0**, as a minimum:

a) **EI/REI 120** fitted with fire resistant and smoke tight doors **EI<sub>2</sub> 60-C5S<sub>200</sub>** in very high above-ground civil constructions with fire stability level **I** of height **h, h < 75m**;

b) **EI/REI 180** fitted with fire resistant and smoke tight doors **EI<sub>2</sub> 90-C5S<sub>200</sub>** in very high above-ground civil constructions with fire stability level **I** of height **h, h ≥ 75m**;

(2) Groupings of rooms with low fire risk and the same destination, including collateral destinations, including horizontal functional communications (such as changing rooms + toilet facilities; desks + lock chamber access) as well as those specific to the health function (MRI room + command room + lock chamber access; CT room computer camera + control room + smart access solutions, etc.) partitioned together with opaque panels or glazed panels, fixed or movable, used as functional separation and/or sound insulation or functional internal walls or partitions, shall be permitted within the following areas constructed in very high health buildings:

- maximum **400 m<sup>2</sup>**, provided that the built-up area of open space type is a maximum of **50%** of the constructed area of the respective building/fire compartment level, for very tall buildings classified in fire stability level **I** with height **h, 45m ≤ h < 75 m**;

- maximum **300 m<sup>2</sup>**, provided that the built-up area of open space type is a maximum of **50%** of the constructed area of the respective building/fire compartment level for health care buildings classified in fire stability level **I** with height **h, 75m ≤ h < 125 m**;

- maximum **200 m<sup>2</sup>**, provided that the built-up area of open space type is not more than **50%** of the built-up area of the respective building/fire compartment level for health care buildings classified in fire stability level **I** with height **h, h ≥ 125 m**.

(3) Partition walls provided between groups of rooms referred to in **paragraph 2** and between them and other spaces in the building (arranged at the boundary of the common escape routes - corridors, protected clearances, overpressure ventilated buffer rooms, enclosed stairways,

etc.). as well as to spaces of different fire risk - according to the heat load densities ( $q$ ) of adjacent spaces and/or the highest heat load densities ( $q$ ) of the spaces they separate and/or those of different fire risk from the function), shall have a reaction to fire classification **A1** or **A2s1d0** and the minimum fire resistance classification of partition walls intended to limit the spread of fire (fire protection walls that limit the spread within fire compartments (**REI/EI**)) as specified in Table 2 **Order No 5** (if the heat load density in adjacent spaces does not generate higher performance).

(4) Premises of the same type used by persons who cannot evacuate themselves located in very tall health care buildings [hospital or hospital-like buildings - hospitals, maternity wards, polyclinics, medical stations, dispensaries, multi-purpose medical and health centres, clinics and outpatient medical units similar to polyclinics, medical diagnostic and treatment centres, nursing homes or homes for the elderly and disabled, hospices for the mentally retarded, sanatoriums, etc.]] constituted in groups of open rooms are not allowed, with the exceptions specified. Low-risk premises with the same destination included in the health function which are not used by persons who cannot evacuate themselves, they may be formed in open space groupings.

(5) Sleeping or hospitalisation rooms (rooms, reserves, medical practices, etc.), with the exception of those requiring permanent surveillance (ATI), (UPU, etc.) may not be formed into open-space groupings and must be separated by a minimum (if the function or density of heat load in adjacent spaces does not produce higher performance) internal non-partition walls limiting the spread of fire **EI60** for buildings for height  $h < 125$  m and **EI 90** for those of height  $h \geq 125$  m.

(6) Operating chambers together with their collateral destinations (washers, hand stores of specific medical instrumentation, etc.) and premises requiring permanent surveillance (ATI) and advisable at (UPU, etc.) may form each in the open space grouping. They also require the provision of fire resistant doors (sliding) **EI<sub>2</sub> 60-C5S<sub>200</sub>**.

(7) The groupings of open rooms referred to in the preceding paragraphs shall have at least two separate and independent escape routes so arranged and constructed that they can be easily accessible to users. The evacuation routes of users shall comply with the composition conditions laid down in the regulations and the standard discharge lengths. It is advisable that for very high buildings intended for persons who cannot escape on their own (defined according to terminology) and very high construction works, equipment or apparatus of particular importance in height  $h \geq 125$  m there shall be a minimum of three escape routes (two distinct and independent) so arranged and constructed that they can be easily accessible to users. The third escape path is not required to fulfil the normal escape path length.

#### **4.2.4. CONSTRUCTIONAL ARRANGEMENTS OF BUILDING ELEMENTS**

**Article 4.2.4.1. (1)** In very high buildings, walls, floors and roofs are made of construction products the reaction to fire class **A1** or **A2-s1d0**.

(2) Construction products used for external finishing, including thermal insulation or cladding of perimeter closures (external walls of any kind except curtain walls and metal profile joinery), shall be the reaction to fire class **A1** or **A2-s1d0**.

(3) Roofs, including terraces, are made of materials of the reaction to fire class **A1** or **A2-s1d0** (thermoinsulation mounted on the support **A1** or **A2-s1d0**), with the exception of the respective hydro-insulation of refrigerators, which may be of the reaction to fire class or more **C-s1, d0**).

(4) The total thermal load density ( $q$ ) resulting from building materials and elements, finishes, furniture and other housed materials in rooms is recommended not to exceed **630 MJ/m<sup>2</sup>**.

**Article 4.2.4.2. (1)** The perimeter closures of very high buildings shall be designed and carried out in such a way as to ensure that the spread of fire from one level to another is limited under conditions **Article 2.3.6.1.2.** and **Article 2.3.6.1.3** to delay the propagation of fires between construction levels outside perimeter closure (on facades), and for the delay of fire propagation through the interior of the construction, the gaps between the floor and the curtain wall shall be sealed by systems having the same fire resistance as the floor, but at least **EI 120**

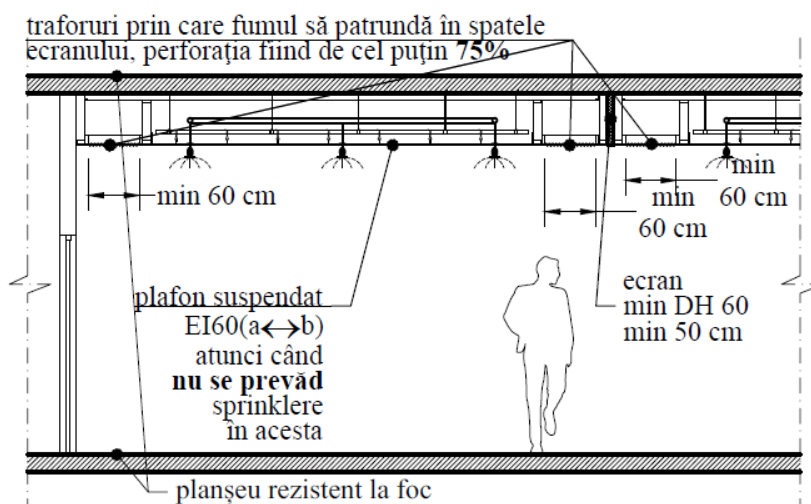
(2) In order to limit the spread of fire from one level to another outside the construction (on the facade), curtain walls used in very high buildings shall meet the requirements of **sub-chapter 2.4.7.1.** on very high buildings.

(3) In very tall buildings, at least up to a height of **42 m** above the surrounding ground or the carriageway outside the curtain walls, the places where fire-fighting units can enter the building shall be clearly marked.

(4) In very tall buildings with a height **h**,  $h \geq 75 \text{ m}$ , at least up to a height of **72 m** above the surrounding ground or carriageway on the outside of curtain walls, the places where fire-fighting units can enter the building shall be clearly marked.

**Article 4.2.4.3. (1)** Continuous or discontinuous/modular surface ceilings of the perforated, lamellar, comb or grill type (both full and non-full) in very high buildings are made of materials in the reaction to fire class **A1** or **A2-s1d0**. In addition, full (self-supporting or suspended) ceilings (with continuous surface) will be fire-resistant **EI 60 (a ↔ b)**. Ceilings with a discontinuous/modular surface of the perforated, lamellar, honeycomb or grill type shall have fire-resistant suspension elements and assemblies **R 60**.

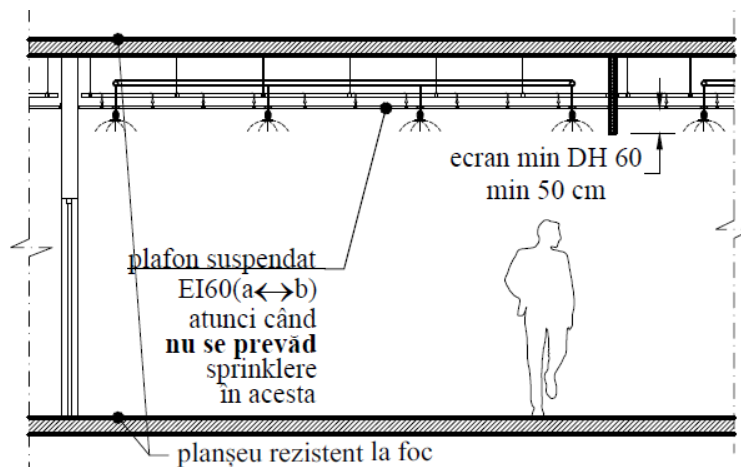
(2) In the case of suspended full ceilings (with continuous closed surface), the continuity of the space between the suspended ceiling and the load-bearing floor shall be interrupted by continuous diaphragms minimum **DH 60**, arranged at a maximum distance of **30 m** in two perpendicular directions, when the space between the suspended ceiling and the load-bearing floor **is not equipped** with an automatic sprinkler system. In this case the ceilings (self-supporting or suspended) full (with continuous surface) will be fire-resistant **EI 60 (a ↔ b)**, according to Figure 73. In all cases, account shall be taken of the provisions of **Article 8.1.2.**



traforuri prin care fumul să pătrundă în spatele ecranului, perforația fiind de cel puțin 75%	perforations through which smoke can penetrate behind the screen, the bottom perforation being at least 75%.
min 60 cm	min. 60 cm
plafon suspendat	suspended ceiling
EI60(a ↔ b) atunci când <b>nu se prevăd</b> sprinklere in acesta	EI60 (a ↔ b) when <b>no sprinklers</b> are foreseen in it
ecran min DH 60 min 50 cm	screen of min DH 60 min 50 cm
planșeu rezistent la foc	fire resistant floor

**Variant a) interruption with continuous diaphragms DH 60, min 50 cm not exceeding the height of the suspended ceiling (variant with perforations)**



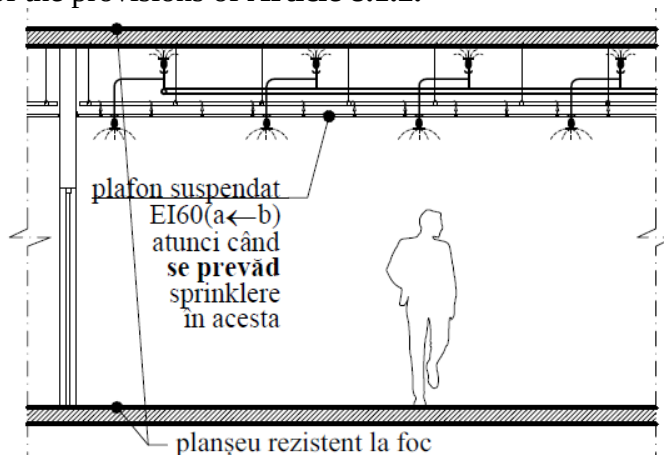


plafon suspendat	suspended ceiling
EI60(a↔b) atunci când <b>nu se prevăd</b> sprinklere in acesta	EI60 (a↔b) when <b>no sprinklers</b> are foreseen in it
ecran min DH 60 min 50 cm	screen of min DH 60 min 50 cm
planșeu rezistent la foc	fire resistant floor

**Variant b) interruption with continuous diaphragms DH 60 exceeding the height of the suspended ceiling by at least 50 cm (variant without perforations)**

**Figure 73 - Diaphragm interruption of ceilings with continuous or discontinuous/modular surface in very high buildings (when the space between the suspended ceiling and the load-bearing floor is not equipped with an automatic sprinkler system according to SR EN 12845)**

(3) In the case of suspended full ceilings (with continuous closed surface), the continuity of the space between the suspended ceiling and the load-bearing floor shall not be interrupted by continuous diaphragms when the space between the suspended ceiling and the load-bearing floor is equipped with an automatic sprinkler system. In this case, the (freestanding or suspended) solid (continuous surface) ceilings will be fire resistant **EI 60 (a ← b)**, as shown in Figure 74. In all cases, account shall be taken of the provisions of **Article 8.1.2**.



plafon suspendat	suspended ceiling
EI60(a↔b) atunci când <b>se prevăd</b> sprinklere in acesta	EI60 (a↔b) when <b>no sprinklers</b> are foreseen in it
planșeu rezistent la foc	fire resistant floor

**Figure 74 - Ceilings with continuous or discontinuous/modular surface in very high buildings where diaphragm interruption is not required (when the space between the suspended ceiling and the load-bearing floor is equipped with automatic sprinkler system according to SR EN 12845)**

**Article 4.2.4.4. (1)** Interior finishes of walls, ceilings and floors of rooms (except for common functional circulation and user escape routes) in high-rise buildings shall be of reaction to fire class **B-s1d0**, respectively minimum **B<sub>FL</sub>-s1**.

**(2)** In open-plan rooms and spaces (working spaces - for the administrative function), fire reaction class finishes of minimum **B-s2d0** made of foils with a maximum thickness of **0.5 cm**, glued on **A1** or **A2-s1d0** backing and minimum **BFL-s1** carpets, with a maximum thickness of **2 cm**, are also allowed, mounted directly or on a sound-absorbing/impact-absorbing layer **A1** or **A2-s1d0**, which are glued or loose-fitted to the backing **A1** or **A2-s1d0**, where open-plan rooms are bounded by escape corridors to overpressure-ventilated buffer rooms at escape staircases.

**(3)** In open rooms and spaces (working - for administrative function), for activities requiring frequent communication, fire reaction class finishes of minimum **B-s1d0** made of foils with a maximum thickness of **0,5 cm** glued on **A1** or **A2-s1d0** backing and minimum **B<sub>FL</sub>-s1** carpet, with a maximum thickness of **2 cm**, are also allowed, mounted directly or on an impact sound absorbing/vibration damping layer **A1** or **A2-s1d0**, which are bonded to the backing **A1** or **A2-s1d0** when the open (working - for administrative function) rooms for activities requiring frequent communication are with direct access to protected, overpressure ventilated buffer rooms at escape stairways.

**(4)** Raised floors used in rooms shall be made according to **Art. 2.4.5.4**.

**(5)** Indoor thermal and noise treatments and insulations used in rooms shall be the reaction to fire class **A1** or **A2-s1d0**, respectively **A1<sub>FL</sub>** or **A2<sub>FL</sub>- S1**.

**Article 4.2.4.5. (1)** Vertical garbage cans for installations are separated from the rest of the very tall building by fire class **A1, A2s1d0** walls with minimum fire resistance **EI/REI 60 for heights up to h<125m and EI/REI 90 for heights h≥125m**. Entrance hatches and doors in the walls of vertical garbage cans must be made of materials **A1, A2s1d0** of a minimum fire resistance **EI 45 for heights of up to h<125 m and EI/60 for heights with h ≥ 125** and shall not be placed in the escape stairways. In this case the vertical garbage cans are sealed around and inside (where technically justified) the ducts and around the cables when passing through the floor slabs, with non-combustible materials having the same fire resistance as the pierced element.

**(2)** Where it is not technically possible or technically justified to seal pipes and cables in vertical guides for installations in front of floors, the bulkheads shall be the reaction to fire class **A1, A2s1d0** of a minimum fire resistance **EI/REI 120 for heights up to h<125 m and EI/REI 180 for heights with h ≥ 125m**, and their doors or apertures will be made from materials **A1, A2s1d0** with a minimum fire resistance of **EI 90** and shall not be located in the escape stairways.

**Article 4.2.4.6.** Vertical garbage cans shall be separated when passing through floors delineating fire compartments with elements and materials reaction class to fire **A1, A2s1d0** which will provide the same fire resistance as the floor through, and when separation is not technically possible or justified, the garbage cans walls shall be made of **A1, A2s1d0 materials** of minimum **EI/REI180 for heights of up to h<125 m and EI/REI 240 for heights of h ≥ 125m** and their guest doors (hatches) will be made of **A1, A2s1d0 materials** of minimum **EI120**.

**Article 4.2.4.7.** In high-rise multi-dwelling buildings, the walls and floors separating the dwelling units from the common functional circulation and evacuation routes of the users shall comply with the provisions of **Art. 4.2.5.2.** and **Art. 4.2.5.3.** and Table 95 and Table 96, specific in the Rules.

**Article 4.2.4.8.** Storage rooms with density of heat load above **420 MJ/m<sup>2</sup>** (middle-risk or heat load density **420 MJ/m<sup>2</sup> ≤ q < 840 MJ/m<sup>2</sup>**) and rooms with a heat load density greater than or equal to **840 MJ/m<sup>2</sup>** (classified as high risk or density of heat load **840 MJ/m<sup>2</sup> ≤ q < 1,680 MJ/m<sup>2</sup>**) are separated from the rest of the very tall building by fire-resistant walls and fire-resistant floors, fire reaction class **A1 or A2-s1d0**, respectively functional gaps as specified in Table 94 and are provided with exhaust systems for smoke and hot gases by means of natural-organised draught or

mechanical ventilation according to the provisions of the standard and specific technical regulations.

**Table94: Minimum separation requirements for storage rooms with a heat load density  $\geq 420 \text{ MJ/m}^2$  in very tall above-ground civil buildings**

Stability level		STORAGE ROOMS			
		$\leq 36 \text{ m}^2$		$> 36 \text{ m}^2$	
		MIDDLE RISK	HIGH RISK	MIDDLE RISK	HIGH RISK
		$420 \text{ MJ/m}^2 \leq q < 840 \text{ MJ/m}^2$	$840 \text{ MJ/m}^2 \leq q < 1680 \text{ MJ/m}^2$	$420 \text{ MJ/m}^2 \leq q < 840 \text{ MJ/m}^2$	$840 \text{ MJ/m}^2 \leq q < 1680 \text{ MJ/m}^2$
<b>I</b> $h \geq 125 \text{ m}$	<b>Walls</b>	<b>EI/REI 120</b>	<b>EI/REI 180</b>	<b>EI/REI 180</b>	<b>EI/REI 240</b>
	<b>Floor slabs</b>	<b>REI 120</b>	<b>REI 180</b>	<b>REI 180</b>	<b>REI 180</b>
	Fire-resistant and smoke-tight doors	EI <sub>2</sub> 90-C3S <sub>200</sub> Or buffer rooms 2 x EI <sub>2</sub> 45-C3S <sub>200</sub>	protected buffer rooms, 2 x EI <sub>2</sub> 60-C3S <sub>200</sub>	EI <sub>2</sub> 120-C3S <sub>200</sub> Or buffer rooms 2 x EI <sub>2</sub> 60-C3S <sub>200</sub>	protected buffer rooms, 2 x EI <sub>2</sub> 90-C3S <sub>200</sub>
<b>I</b> $h \geq 125 \text{ m}$	Rooms with high fire risk (except those with very high risk and those with volumetric explosion hazard/risk, which are not allowed), with heat load density $840 \text{ MJ/m}^2 \leq q < 1,680 \text{ MJ/m}^2$ , with surface area $> 36 \text{ m}^2$ are allowed only in a separate compartment of the very tall building, adjacent, with normal height regime (can have EI/REI 180 walls and REI 120 floors) or in an area of maximum $400 \text{ m}^2$ only in the lower quarter of the very tall building. Storage rooms with heat load density greater than $210 \text{ MJ/m}^2$ and smaller than $420 \text{ MJ/m}^2$ , $\leq 36 \text{ m}^2$ will have EI/REI 90 walls and their doors will be EI <sub>2</sub> 45-C3S <sub>200</sub> and those $> 36 \text{ m}^2$ will have EI/REI 120 walls and their doors will be EI <sub>2</sub> 60-C3S <sub>200</sub> .				
<b>I</b> $75\text{m} \leq h < 125 \text{ m}$	<b>Walls</b>	<b>EI/REI 120</b>	<b>EI/REI 180</b>	<b>EI/REI 180</b>	<b>EI/REI 180</b>
	<b>Floors</b>	<b>REI 120</b>	<b>REI 180</b>	<b>REI 120</b>	<b>REI 180</b>
	Fire-resistant and smoke-tight doors	EI <sub>2</sub> 60-C3S <sub>200</sub> Or buffer rooms 2 x EI <sub>2</sub> 30-C3S <sub>200</sub>	protected buffer rooms, 2 x EI <sub>2</sub> 45-C3S <sub>200</sub>	EI <sub>2</sub> 90-C3S <sub>200</sub> Or buffer rooms 2 x EI <sub>2</sub> 45-C3S <sub>200</sub>	protected buffer rooms, 2 x EI <sub>2</sub> 60-C3S <sub>200</sub>
<b>I</b> $75\text{m} \leq h < 125 \text{ m}$	Rooms with high fire risk (except those with very high risk and those with volumetric explosion hazard/risk, which are not allowed), with heat load density $840 \text{ MJ/m}^2 \leq q < 1,680 \text{ MJ/m}^2$ , with surface $> 36 \text{ m}^2$ are only allowed in a separate compartment of the very tall building, adjoining, with normal height regime (can have EI/REI 180 walls and REI 180 floors) or in an area of maximum $400 \text{ m}^2$ only in the lower third of the very tall building. Storage rooms with heat load density greater than $210 \text{ MJ/m}^2$ and smaller than $420 \text{ MJ/m}^2 \leq 36 \text{ m}^2$ will have EI/REI 90 walls and their doors will be EI <sub>2</sub> 45-C3S <sub>200</sub> and those $> 36 \text{ m}^2$ will have EI/REI 120 walls and their doors will be EI <sub>2</sub> 60-C3S <sub>200</sub> .				
<b>I</b> $45\text{m} \leq h < 75\text{m}$	<b>Walls</b>	<b>EI/REI 90</b>	<b>EI/REI 120</b>	<b>EI/REI 120</b>	<b>EI/REI 180</b>
	<b>Floors</b>	<b>REI 120</b>	<b>REI 120</b>	<b>REI 120</b>	<b>REI 180</b>
	Fire-resistant and smoke-tight doors	EI <sub>2</sub> 45-C3S <sub>200</sub> Or buffer rooms 2 x EI <sub>2</sub> 20-C3S <sub>200</sub>	protected buffer rooms, 2 x EI <sub>2</sub> 30-C3S <sub>200</sub>	EI <sub>2</sub> 60-C3S <sub>200</sub> Or buffer rooms 2 x EI <sub>2</sub> 30-C3S <sub>200</sub>	protected buffer rooms, 2 x EI <sub>2</sub> 45-C3S <sub>200</sub>
<b>I</b> $45\text{m} \leq h < 75\text{m}$	Rooms with high fire risk (except those with very high risk and those with volumetric explosion hazard/risk, which are not allowed), with heat load density $840 \text{ MJ/m}^2 \leq q < 1,680 \text{ MJ/m}^2$ surface area $> 36 \text{ m}^2$ may be admitted only in the separate compartment of the very high, matured building of normal height or in an area not exceeding $400 \text{ m}^2$ only in the lower half of the very tall building. Storage rooms with heat load density greater than $210 \text{ MJ/m}^2$ and smaller than $420 \text{ MJ/m}^2 \leq 36 \text{ m}^2$ will have EI/REI 60 walls and the doors in them will be EI <sub>2</sub> 30-C3S <sub>200</sub> and those $> 36 \text{ m}^2$ will have EI/REI 90 walls and the doors in them will be EI <sub>2</sub> 45-C3S <sub>200</sub> .				
<b>Obse</b>	Rooms with a very high fire risk or volumetric explosion risk are not allowed in very high building				

Stability level	STORAGE ROOMS			
	≤ 36 m <sup>2</sup>		> 36 m <sup>2</sup>	
	MIDDLE RISK	HIGH RISK	MIDDLE RISK	HIGH RISK
	420 MJ/m <sup>2</sup> ≤ q < 840 MJ/m <sup>2</sup>	840 MJ/m <sup>2</sup> ≤ q < 1680 MJ/m <sup>2</sup>	420 MJ/m <sup>2</sup> ≤ q < 840 MJ/m <sup>2</sup>	840 MJ/m <sup>2</sup> ≤ q < 1680 MJ/m <sup>2</sup>
rvation	<p>compartments, except as permitted by other specific regulations. For permitted activities with the risk of volumetric explosion arranged technically or functionally at all levels of construction (including the terrace of the last level of very high civil engineering), it is mandatory to ensure appropriate partitioning measures to other areas and functions with elements resistant to fire and volumetric explosion, in accordance with the applicable legislation and technical regulations. (e.g. thermal power plants located on buildings). In high civil engineering, handling, processing or storage of materials and substances at risk of volumetric explosion shall not be permitted, as well as the location of workshops where such materials are used, with the exception of those established by specific regulations (laboratories, pharmacies, hospitals, etc.). Rooms with heat load density above <b>1,680 MJ/m<sup>2</sup></b> are not allowed.</p> <p>Storage rooms with a floor area greater than <b>36 m<sup>2</sup></b> and a heat load greater than <b>105MJ/m<sup>2</sup></b> shall be provided with exhaust systems for smoke and hot gases by natural-organised draught or by mechanical ventilation, according to the provisions of the standard and specific technical regulations. The total useful/aerodynamic area of the free area of devices with automatic smoke discharge aperture in the event of organised natural fire, shall be at least <b>1 %</b> from the surface of the floor coverings. When smoke exhaust is provided by mechanical ventilation, the provisions of the Rule and/or technical regulations shall be complied with.</p>			

**Article 4.2.4.9. (1)** The partitioning elements between car parking spaces and very high buildings to which they attach or incorporate shall be the reaction to fire class **A1** or **A2-s1d0** with minimum fire resistance **EI/REI 240** wall and minimum **REI 180** for floors.

**(2)** In such bulkheads, functional communication gaps shall be permitted if they are protected by protected buffers, ventilated under excess pressure, equipped with fire resistant and smoke tight doors **EI<sub>2</sub> 120-C5S<sub>200</sub>**.

**Article 4.2.4.10. (1)** Lifts intended for the functional movement of persons, goods, goods lifts and other vertical material transport systems in very tall buildings shall be constructed in accordance with specific legislation and shall have their own lift shafts separated from the rest of the construction by fire-resistant walls of at least **EI/REI 180** for lifts intended for the functional movement of persons and **EI/REI 240** for other types of lifts or systems and, where appropriate, fire-resistant floors of at least **REI 180**, reaction to fire class **A1** or **A2-s1d0**. In the walls of lift wells, only functional gaps at building levels (landing doors) are permitted.

**(2)** A maximum of two lift cars intended for the functional movement of persons may be placed in a shaft.

**Article 4.2.4.11. (1)** On the upper floors of very high buildings, access to lifts intended for the functional movement of persons shall be provided by **EI 120** fire-resistant landing grips.

**(2)** On the underground levels of very high buildings, access to lifts intended for the functional movement of persons shall be provided by means of overpressure-ventilated buffer rooms with fire and smoke resistant doors **EI<sub>2</sub>45-C5S<sub>200</sub>** to the horizontal common circulation and fire resistant doors **EI120** to the lift doors; in this case the overpressure ventilated buffer room shall be provided with walls of reaction to fire class **A1** or **A2-s1d0**, with a minimum fire resistance **EI/REI 120**.

**(3)** Exceptions are low fire risk basements, which are separated in the same way as above ground levels.

**Article 4.2.4.12. (1)** On the upper floors of very tall buildings, access to monte-charge freight lifts and other vertical material handling systems shall be provided by means of overpressure ventilated buffer rooms with **EI<sub>2</sub>60-C5S<sub>200</sub>** fire and smoke-tight doors to horizontal common circulation and **EI120** fire doors to lift landing doors; the overpressure ventilated buffer room shall

be provided with walls of reaction to fire class **A1** or **A2-s1d0**, fire resistance minimum **EI/REI 120**.

(2) On the underground levels of very high buildings, access to monte-charge freight lifts and other vertical material handling systems is provided by means of overpressure ventilated buffer rooms with **EI<sub>2</sub>90-C5S<sub>200</sub>** fire and smoke-tight doors to common horizontal circulation and **EI120** fire doors to lift doors; the overpressure ventilated buffer room shall be provided with walls of reaction to fire class **A1** or **A2-s1d0**, fire resistance minimum **EI/REI 120**.

(3) If at least one station opens into a space requiring doors with higher fire resistance performance characteristics (generated by function or heat load density), the lift access gaps shall comply (at least on that level, depending on the situation) with doors and walls to the buffer room in accordance with those conditions.

(4) It is recommended that the lift shafts in the basements of very tall buildings be separated from the lifts of the upper floors.

**Article 4.2.4.13. (1)** In very high civilian buildings, lifts provided for the functional movement of trolley persons or disabled persons which may also be used for their assisted evacuation in the event of fire, where they comply simultaneously with the following conditions:

- a) are provided with their own shaft, equipped with overpressure installation, separated from the rest of the construction with walls of reaction to fire class **A1** or **A2-s1d0** fire resistant minimum **EI/REI 180** and floors of reaction to fire class **A1** or **A2-s1d0** fire resistant minimum **REI 180**;
- b) have ensured operation for a minimum **120** minutes after the outbreak of the fire;
- c) comply with the provisions of **Article 3.1.4.4 paragraph 3 letters c), d), e), f) and g)**.

(2) On the upper floors of very tall buildings, access to lifts intended for the functional movement of wheelchair users or persons with disabilities who can be used and for their assisted evacuation in the event of fire shall be provided by means of overpressure ventilated buffer rooms, provided with fire and smoke-tight doors **EI<sub>2</sub>60-C5S<sub>200</sub>** to horizontal **common circulation for heights up to 75 m** and fire and smoke-tight doors **EI<sub>2</sub>90-C5S<sub>200</sub>** to horizontal **common circulation for heights of h≥75m** and fire resistant doors **EI120** for the lift doors; in this case the overpressure ventilated buffer room shall be provided with walls of reaction to fire class **A1** or **A2-s1d0**, with a minimum fire resistance **EI/REI 120**.

(3) On the underground levels of very tall buildings, access to lifts intended for the functional movement of wheelchair users or persons with disabilities who can be used and for their assisted evacuation in the event of fire shall be provided by means of ventilated overpressure buffer rooms, provided with fire and smoke-tight doors **EI<sub>2</sub>90-C5S<sub>200</sub>** to horizontal **common circulation for heights up to 75 m** and fire and smoke-tight doors **EI<sub>2</sub>120-C5S<sub>200</sub>** to horizontal **common circulation for heights of h≥75m** and fire resistant doors **EI120** for the lift doors; in this case the overpressure ventilated buffer room shall be provided with walls of reaction to fire class **A1** or **A2-s1d0**, with a minimum fire resistance **EI/REI 120**.

(4) If the lifts which can also be used for the assisted evacuation of persons with trolley or disabled persons have a two-access cab, all specified gaps shall meet the conditions of **paragraph 2** and **paragraph 3**.

(5) Lifts provided for the transport of trolley persons or disabled persons which can also be used for their assisted evacuation in the event of fire from very high civilian buildings shall have controls in corridors or safe clearance.

(6) Where access openings to lifts intended for the functional movement of persons and to lifts intended for the transport of wheelchair, stretcher or wheelchair users or disabled persons which can also be used for their assisted evacuation in the event of fire, on the upper floors of very tall buildings open into a ventilated buffer room under common overpressure, all doors to lifts shall be at least **EI120** and the overpressure ventilated buffer zone shall be provided with fire resistant

and smoke-tight doors **EI<sub>2</sub>60-C5S<sub>200</sub>** for heights up to 75 m and with fire resistant and smoke-tight doors **EI<sub>2</sub>90-C5S<sub>200</sub>** to horizontal common circulation for heights of  $h \geq 75$  m and walls of reaction to fire class **A1** or **A2-s1d0**, fire resistant minimum **EI/REI 120**. When opening at underground levels of very tall buildings in a ventilated buffer room in a common overpressure, all doors to lifts shall be minimum **EI120** and fire resistant and smoke-tight doors **EI<sub>2</sub>90-C5S<sub>200</sub>** shall be provided in the overpressure ventilated buffer room for heights up to 75 m and with fire resistant and smoke-tight doors **EI<sub>2</sub>120-C5S<sub>200</sub>** to horizontal **common circulation for heights of  $h \geq 75$  m** and walls of reaction to fire class **A1** or **A2-s1d0**, fire resistant minimum **EI/REI 120**.

(7) Where the access openings to lifts intended for the functional movement of persons, to stairways for the escape of persons and to lifts intended for the transport of wheelchair, wheelchair-bound or disabled persons which can also be used for their assisted evacuation in the event of fire at the upper levels of very tall buildings open into a ventilated buffer room under common overpressure, all lift doors shall be a minimum of **EI120**, the stairwell door shall be at least **EI<sub>2</sub>120-C5S<sub>200</sub>** and fire and smoke-tight doors **EI<sub>2</sub>60-C5S<sub>200</sub>** shall be provided in the overpressure ventilated buffer zone for heights up to 75 m and with fire and smoke-tight doors **EI<sub>2</sub>90-C5S<sub>200</sub>** to the horizontal common circulation for heights up to 75 m and walls of reaction to fire class **A1** or **A2-s1d0**, fire resistant minimum **EI/REI 120**. When opening at the underground levels of very tall buildings in a common overpressure ventilated buffer room, all lift doors shall be a minimum **EI120**, the stairwell door shall be minimum **EI<sub>2</sub>120-C5S<sub>200</sub>** and fire and smoke-tight doors **EI<sub>2</sub>90-C5S<sub>200</sub>** shall be provided in the overpressure ventilated buffer zone for heights up to 75 m and with fire and smoke-tight doors **EI<sub>2</sub>120-C5S<sub>200</sub>** to horizontal **common circulation for heights of  $h \geq 75$  m** and walls of reaction to fire class **A1** or **A2-s1d0**, fire resistant minimum **EI/REI 120**.

(8) Where the functions of high-rise buildings involve the transport of sick persons on stretchers, lifts intended for the transport of sick persons on wheelchairs, stretchers or trolleys or disabled persons which can also be used for their assisted evacuation in the event of fire shall comply with the provisions of the preceding paragraphs (**paragraphs 1 ÷ 7**).

(9) Lifts intended for the transport of patients with a roller bed, stretcher or trolley or disabled persons which may also be used for their assisted evacuation in the event of fire shall have controls in protected corridors or protected release.

**Article 4.2.4.14.** In the event of failure or stoppage, emergency lifts in high-rise buildings, as well as in buildings where such lifts are provided, must be equipped with an access through which stranded firefighters can rescue themselves or with the help of others (e.g. the rescue hatch to be provided in the roof of the car must be equipped with a portable ladder). In the event of a fire, all cabins must be automatically brought to the ground floor and remain shut down until the building's fire command is cancelled. Exception are emergency lifts and lifts for disabled persons which will operate during the fire by means of emergency supply.

**Article 4.2.4.15. (1)** In very tall buildings it is mandatory to provide 2 (two) fire lifts with easy access from the entrance level of the building, designed to meet the requirements of fire fighting operations and provided with priority call for firefighters.

(2) Fire rescue lifts shall be provided with their own wells, separated from each other and both from the rest of the building and from the outside, with fire-resistant walls **REI 180** and, where applicable, minimum fire resistant floors **REI 180** reaction class to fire **A1** or **A2-s1,d0** and access gaps protected by access buffers provided with excess pressure ventilation and fire resistant and smoke tight doors.

(3) Access to emergency lifts on the upper levels of very tall buildings is provided by the construction of overpressure ventilated buffer rooms, provided with fire and smoke-tight doors **EI<sub>2</sub>60-C5S<sub>200</sub>** in buildings up to 75 m high and **EI<sub>2</sub>90-C5S<sub>200</sub>** in buildings over 75 m high to horizontal common circulation and fire doors **EI120** at lift doors and the overpressure ventilated buffer room shall be provided with fire reaction class **A1** or **A2-s1d0** walls, fire resistant minimum **EI/REI 120**. Access to emergency lifts at the underground levels of high rise civil buildings is provided by the construction of overpressure ventilated buffer rooms, provided with fire and smoke-

tight doors **EI<sub>2</sub>90-C5S<sub>200</sub>** in buildings up to **75 m** high and **EI<sub>2</sub>120-C5S<sub>200</sub>** in buildings over **75 m** high to horizontal common circulation and fire doors **EI120** at lift doors and the overpressure ventilated buffer room shall be provided with fire reaction class **A1** or **A2-s1d0** walls, fire resistant to min **EI/REI 120**.

(4) The lifts for intervention in case of fire must comply with the provisions of **Art. 3.1.4.8. paragraphs 3 ÷ 8** and the provisions of **Art. 3.1.4.8. paragraphs 11 ÷ 14**.

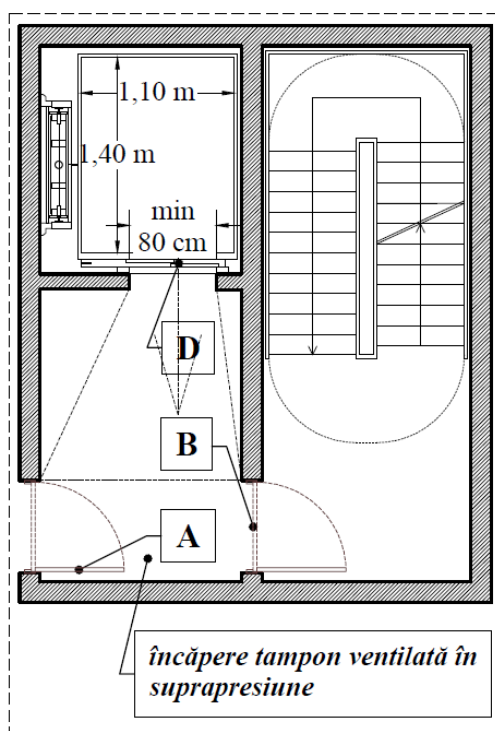
(5) Fire response lifts shall each be positioned within buildings in such a way that they are provided with access to the outside directly from the outside or through smoke shielded spaces of maximum length equivalent to that of the folded corridor dimensions of the very high building.

(6) Intervention lifts shall be provided with a priority call for firefighters and shall provide access for fire response to the above-ground and underground levels of the building. In underground car parks with more than **4** levels incorporated in very tall buildings, the fire lifts for the car parks must be different from the fire lifts for the above ground levels.

(7) The intervention lifts shall be carried out in accordance with the provisions of the specific technical regulations and shall each be operated for time by **120** minutes after the fire outbreak.

(8) When access by firefighters is made via the same evacuation ladder (of persons) in the calculation of the evacuation flows of persons, it is considered as a downward outlet for their evacuation. It is mandatory that the clear width of ramps and stairwells (measured according to the standard provisions) usable for an escape flow of persons as well as fire brigade access is in this case at least **1.20 m**.

(9) In buildings with a height of **75 m** or more, it is mandatory that at least one emergency lift be provided with access from the stairwell buffer room intended solely for firefighters, as shown in Figure 75.



**LEGEND:**

For height **less than 75 m** (advisable) on the above-ground side will meet the following conditions:

- D** - doors **EI 120**
- A** - doors **EI<sub>2</sub>60-C5S<sub>200</sub>**
- B** - doors **EI<sub>2</sub>120-C5S<sub>200</sub>**

For height **less than 75 m** (advisable) on the underground side will meet the following conditions:

- D** - doors **EI 120**
- A** - doors **EI<sub>2</sub>90-C5S<sub>200</sub>**
- B** - doors **EI<sub>2</sub>120-C5S<sub>200</sub>**

For height **greater than or equal to 75 m** (**mandatory**) on the above-ground side, the following conditions shall be met:

- D** - doors **EI120**
- A** - doors **EI<sub>2</sub>90-C5S<sub>200</sub>**
- B** - doors **EI<sub>2</sub>120-C5S<sub>200</sub>**

For height **greater than or equal to 75 m** (**mandatory**) in the underground part the following conditions shall be met:

- D** - doors **EI 120**
- A** - doors **EI<sub>2</sub>120-C5S<sub>200</sub>**
- B** - doors **EI<sub>2</sub>120-C5S<sub>200</sub>**

încăpere tampon ventilată în suprapresiune	ventilated buffer room under excess pressure
--	--

**Figure 75 Lift dedicated to the intervention (mandatory for buildings with a height greater than or equal to 75 m) provided with dedicated access from the buffer room related to the stairwell intended only for the intervention of firefighters**

#### 4.2.5. ESCAPE ROUTES FOR USERS IN CASE OF FIRE

**Article 4.2.5.1. (1)** In very high buildings it is mandatory to ensure a minimum of two separate and independent evacuation routes for users.

**(2)** The evacuation routes of users shall comply with the composition conditions laid down in the regulations and the standard discharge lengths.

**Article 4.2.5.2.** The burning behaviour of walls, doors and separation floors of stairway houses enclosures in very high civil buildings shall comply with the provisions of Table 95.

**Table95: Fire behaviour of walls, doors and separation floors of closed stairway houses in very high elevated civil buildings**

Fire stability level	Permitted reaction to fire levels in closed stairways				
	Walls		Floors (separating stairway houses enclosures from the rest of the construction)		Doors
<b>I</b>	<b>EI/REI 180</b>	<b>A1 or A2-s1d0</b>	<b>REI 120</b>	<b>A1 or A2-s1d0</b>	<b>2xEI<sub>2</sub>90-C5S<sub>200</sub></b> in protected buffer rooms

**Article 4.2.5.3.** The fire behaviour of the walls, doors and separation boards of the horizontal escape routes (corridors and hallways) in very high above-ground civil buildings must correspond to the provisions of Table 96.

**Table96: Fire behaviour of walls, doors and horizontal escape route partitions (corridors and hallways) in high-rise civil buildings**

Fire stability level	Permitted reaction to fire levels in corridors and halls				
	Walls		Floors (separating corridors and halls from the rest of the construction, including their exit paths to the land level or adjacent roads)		Doors (except for stairway houses enclosures)
<b>I</b>	<b>EI/REI 120</b>	<b>A1 or A2-s1d0</b>	<b>REI 120</b>	<b>A1 or A2-s1d0</b>	<b>EI<sub>2</sub> 45 - C5S<sub>200</sub></b>

**Notes:**

*In the case of glazed metal walls separating corridors and halls from adjacent rooms, the reaction to fire class shall not be taken into account.*

*Lift lobbies of public buildings can communicate freely with public spaces on the level if the fire performance of the lift doors is **EI120** (**EI180** for buildings over 75 m).*

**Article 4.2.5.4. (1)** At all levels of the very tall building, each of the users' escape stairways shall be accessible via a protected overpressure ventilated buffer room on independent travel paths and in different directions along the standard escape length.

**(2)** At least 2 of the evacuation ladders of the very high building will have access to the terrace.

**Article 4.2.5.5.** When using escalators the provisions of **Art.2.5.6.3.3.** of the Rules shall be observed.

**Article 4.2.5.6. (1)** The evacuation routes of users of very high buildings shall respect the evacuation lengths specified in Table 97.



(2) The maximum permissible exhaust lengths shall be determined for the escape route travelled from the room door to the nearest entrance door to the ventilated protected buffer room over pressure of the stairway enclosure.

(3) If the distance travelled within the room to the door provided in the fire resisting wall (bounding the corridor from the room) is less than the maximum escape length permitted for escape in one direction only, then the length of the two separate and independent escape routes required shall be measured from the room door, and the escape route from the door of the room to the nearest door of entry to the buffer room of the nearest enclosed escape staircase is required to be less than the maximum escape length permitted for two-way escape.

(4) If the distance travelled within the room to the door provided in the fire resistant wall (delineation of the corridor from the room) is greater than the maximum length of escape permitted for evacuation in one direction, then two escape routes within the head are required and the length of the two separate and independent escape routes required shall be measured from the most unfavourable point within the room, the escape route flowing from that point to the nearest entrance door to the buffer room of the nearest stairway enclosure shall be less than the maximum length of discharge permitted for evacuation in two directions.

(5) The permissible normal discharge length shall be provided inside the rooms.

**Table 97: Exhaust lengths in very high above-ground buildings**

Destination of the very high building	Maximum exhaust length	
	in two different directions	in a direction (dead-end corridor)
	m.	m.
Administrative, education, tourism, health, commerce, worship, collective housing, etc.	25	15

Notes:

a) The exhaust length in one direction (dead-end corridor) also refers to the interior of rooms and living quarters respectively.

b) For crowded rooms in very high buildings, the specific performance requirements for very high buildings shall be complied with, and the construction ladders may be used for the evacuation of users, provided that they also meet the composition and dimensioning requirements for crowded rooms.

c) Crowded rooms in very tall buildings located in portions of very tall buildings up to and including + 42 m shall comply with the performance provisions specific to very tall buildings, and the use of staircases in very tall buildings for the evacuation of users shall be permitted if they also meet the design and dimensioning conditions for crowded rooms. Crowded rooms within high-rise buildings arranged in fire compartments functionally and constructively separated from the rest of the high-rise building, located up to and including + 42 m within the volume of the high-rise building, which have their own staircases (if they also fulfil the conditions for the design and dimensioning of staircases for crowded rooms) for the evacuation of all users of the crowded rooms, do not trigger the fulfilment of the conditions for the design and dimensioning for crowded rooms of the other evacuation staircases of the high-rise building.

**Article 4.2.5.7.** The standard number of users per evacuation flow unit ( $U_f$ ) in very high rise buildings is **70 users**. The standard number of users per evacuation flow unit ( $U_f$ ) in very high rise buildings for people who cannot evacuate themselves (defined according to the terminology) is **40 users**.

**Article 4.2.5.8. (1)** On the above-ground levels of very tall buildings, access to enclosed escape stairways is permitted only through protected, overpressure-ventilated buffer rooms as specified in the regulations.

(2) Protected buffer rooms will have minimum **EI/REI 90** fire resistant walls and **REI 90** floors, reaction to fire class **A1** or **A2-s1d0**, and circulation gaps with **EI<sub>2</sub> 90-C5S<sub>200</sub>** fire resistant and smoke tight doors and will be pressurised.

(3) Buffer room doors leading to escape stairwells shall be provided with panic bars and shall open in the direction of escape regardless of the number of persons.

(4) Escape doors starting outside the construction shall be fitted with anti-panic bars.

**Article 4.2.5.9. (1)** On the underground levels of very tall buildings, access to enclosed escape staircases shall be provided only through protected, overpressure-ventilated buffer rooms constructed with minimum **EI/REI 120** fire resisting walls, **REI 90** floors, reaction to fire class **A1** or **A2-s1d0** and **EI<sub>2</sub> 90-C5S<sub>200</sub>** fire and smoke-tight doors.

(2) Doors in buffer rooms shall be fitted with anti-panic bars.

(3) Escape doors starting outside the construction are provided with anti-panic bars.

**Article 4.2.5.10. (1)** The stair landings of closed staircases on underground levels are separated from the stair landings of above-ground levels by fire-resistant walls **EI/REI 180** and floors **REI 180**, reaction to fire class **A1** or **A2-s1d0**.

(2) Functional communication between the underground staircase landings and the staircase landings above ground may be provided by a fire-resistant and smoke-tight door **EI<sub>2</sub> 120-C5S<sub>200</sub>**, located on the ground floor or intermediate landing between the ground floor and the first basement level, opening in the direction of escape.

(3) If there is no communication between the underground and the above-ground ramp, the exit gap of the underground ramp into the ground floor hallway shall be protected by a fire-resistant and smoke-tight door **EI<sub>2</sub> 120-C5S<sub>200</sub>**, opening in the direction of escape.

**Article 4.2.5.11. (1)** The interior finishes of walls, ceilings and floors of common functional circulation and escape routes of users of high-rise buildings shall be of reaction to fire class **A1** or **A2-s1d0** or **A1<sub>FL</sub>** or **A2<sub>FL</sub>-s1** respectively.

(2) On the common horizontal functional circulation and escape routes of users (corridors, hallways), finishes of reaction to fire class **B-s1d0** minimum, made of foils with a maximum thickness of **0.5 cm**, glued on **A1** or **A2-s1d0** backing, and carpet, **B<sub>FL</sub>-s1** minimum, with a maximum thickness of **2 cm**, mounted directly or on an impact sound insulating layer, glued on **A1** or **A2-s1d0** backing, are also allowed.

(3) Elevated floors shall be carried out in accordance with **Article 2.4.5.4**.

(4) Interior thermal and sound insulation and treatments used on common circulation routes shall be of reaction to fire class **A1** or **A2-s1d0** or **A1<sub>FL</sub>** or **A2<sub>FL</sub>-s1** respectively.

**Article 4.2.5.12. (1)** Horizontal common corridors (corridors, hallways, vestibules) shall be provided with mechanically ventilated smoke and hot gas exhaust systems or shall be pressurised in accordance with the provisions of the standard and technical regulations.

(2) Exhaust of smoke and hot gases in case of fire from enclosed stairwells and their buffer rooms shall be pressurised. The evacuation of smoke and hot gases in case of fire from enclosed underground stairwells and their buffer rooms shall be ensured only by means of an organised natural draught, or they shall be pressurised.

(3) The evacuation of smoke and hot gases in the event of fire from stairway houses and horizontal underground common circulations shall be ensured separately from those of the above-ground levels.

## **4.2.6. FIRE ACCESS, INTERVENTION AND RESCUE CONDITIONS**

**Article 4.2.6.1.** In very tall buildings, access and escape routes for emergency vehicles shall be provided on at least two (2) adjacent sides and at least 50% of the perimeter of the exterior walls.

(2) In accordance with the simultaneous maximum capacity of the very tall building, the provisions of **Art. 2.6.7. paragraphs 1, 2 and 3**. For a maximum simultaneous capacity of more than **2,500** persons, **Article 2.6.7. paragraph 3** shall not be taken into account.

## **4.2.7. EQUIPPING BUILDINGS WITH FIRE-FIGHTING INSTALLATIONS AND APPLIANCES**

**Article 4.2.7.1. (1)** Very tall buildings shall be equipped with fire-fighting installations and means, as well as fire detection, signalling and alarm installations, in accordance with the provisions of the relevant technical regulations.

**(2)** Very tall civil buildings shall be equipped with fire extinguishers, providing a portable fire extinguisher with minimum extinguishing performance **21A** and **113B** for an unfolded area of maximum 200 m<sup>2</sup>, but a minimum of two extinguishers per building level.

## **SECTION III**

### **4.3. Civil buildings with crowded rooms**

#### **4.3.1. COMMON BUILDING PERFORMANCE CONDITIONS (Fire risk, Fire stability level of the building)**

**Article 4.3.1.1. (1)** Fire safety measures for crowded rooms shall be determined according to the purpose, the category of the crowded room, the maximum simultaneous user capacity, the condition of the users, the number of levels and the fire stability level of the building.

**(2)** The fire stability level of buildings with crowded rooms shall be determined in accordance with **Art. 2.1.3.2** and Table 2.

**(3)** For multi-purpose rooms, fire safety measures shall be provided according to the most unfavourable classification category of the room.

**Article 4.3.1.2. (1)** Depending on the purpose, crowded rooms are classified as category S1 or category S2 as specified in Table 98.

**(2)** Crowded rooms whose purpose is not mentioned in Table 98, are classified by assimilation.

**Table98: Categories of crowded rooms**

<b><i>Crowded room category</i></b>	<b><i>Destination of the crowded room</i></b>
<b><i>S1</i></b>	<i>Theatres, concert halls, circuses, trade exhibitions and museums with combustible exhibits, discos, clubs, etc.</i>
<b><i>S2</i></b>	<i>Meeting rooms, conferences, concerts, sports, waiting, worship, shops and shopping centres, cinema screenings, reading, museums with non-combustible exhibits, exhibitions, auditoriums, canteens, restaurants, cloakrooms, etc.</i>

#### **4.3.2. - BUILDINGS LOCATION CONFORMATION**

**Article 4.3.2.1. (1)** Buildings with crowded rooms that ensured the level **I**, **II** or **III** fire stability, shall be such as to meet the standard correlation requirements, as follows:

**a)** Between the location mode, the category of the overground crowded room and the maximum simultaneous user capacity allowed, as specified in Table 99.

**Table99: Correlation between the location mode, the category of the overground crowded room and the maximum simultaneous user capacity allowed**

Location of the crowded room	Crowded room category	Maximum simultaneous user capacity depending on the level of fire stability of the building		
		I	II	III
Independent or fire compartment	S1	Unlimited	5,000	2,000
	S2		Unlimited	2,500
Attached to one side of a building with another purpose or combining several crowded rooms in a building with no other purpose	S1	5,000	3,000	1,500
	S2	6,000	4,000	2,000
Incorporated in the building with another purpose	S1	3,000	2,000	1,000
	S2	5,000	3,000	1,500

b) Between the crowded room category (the portion where the public has access) and the maximum number of above-ground levels permitted in which crowded rooms may be arranged, as specified in Table 100.

**Table 100: Correlation between the category of crowded room (the portion where the public has access) and the number of levels above ground where they are allowed to be built**

Crowded room category	Maximum number of floors above ground on which crowded rooms may be arranged		
	I	II	III
S1	Unlimited	5	2
S2	Unlimited	6	3

c) Between the crowded room category (the portion where the public has access) and the permitted number of underground levels in which crowded rooms may be arranged, as specified in Table 101.

**Table 101: Correlation between the category of crowded room (the portion where the public has access) and the maximum number of underground levels where they are allowed to be built**

Crowded room category	Maximum number of underground levels where crowded rooms can be arranged		
	I	II	III
S1	2	1	-
S2	2	1	-

**Article 4.3.2.2. (1)** In self-contained, ground floor, temporary buildings (constructions) of fire stability level IV or V, crowded rooms may only be provided for:

- a) mobile circuses, shopping areas, occasional meeting rooms, skippers, hockey grounds, swimming pools and similar;
- b) clubs, discotheques and cinemas operating seasonally, not exceeding 300 by users;
- c) exhibitions of local importance that do not host valuable or heritage exhibits (as stated by the investor or beneficiary).

(2) In temporary buildings (constructions) with crowded rooms, a minimum of two escape routes shall be provided for users and the lengths of the normal escape routes from the furthest site to an exit outside.

**Article 4.3.2.3. (1)** The building portions of crowded rooms incorporated into constructions for other purposes shall be separated with minimum fire resistant building elements **EI/REI180** wall and minimum **EER 90** for floors. Similarly, portions of buildings relating to several clustered crowded rooms are separated from each other, regardless of their use.

(2) In clubs and discotheques, the activity areas can communicate freely with the reception areas of crowded rooms.

(3) Lockers, offices, amphitheatres and meeting rooms in administrative, education, health, sport, culture, tourism, worship, etc. buildings may have escape routes shared with those of the building in which they are located.

(4) Crowded rooms in a building with another purpose may communicate with the common portions of the building where they are located through functional circulation and exhaust openings protected by fire resistant and smoke-tight doors minimum EI<sub>2</sub> 30-C5S<sub>200</sub>.

**Article 4.3.2.4. (1)** The portions of the building related to the rooms of buildings with other uses can be constituted in distinct fire compartments, functionally independent, delimited from the rest of the building according to the normative provisions, the partition can be carried out within the limits of the fire compartments established for each type or distinct function according to the normative provisions, ensuring separation of different types and/or functions with vertical and horizontal building elements with fire resistances determined according to the heat load density (q) in adjacent spaces, but not less than **REI 180** or **EI-M 180** for walls and **REI 120** for floors and gap protection as specified in the regulations. For each separate fire compartment, access and escape routes for users shall be provided, as well as road access routes suitably dimensioned for the movement and location of fire-fighting and rescue vehicles, on at least two sides.

(2) Where portions of a building relating to crowded rooms constitute separate, functionally independent fire compartments within civil constructions of normal height, the passive protection measures specific to buildings with crowded rooms shall apply only to the compartments comprising crowded rooms, with the exception of the provision for each compartment of at least two separate escape routes for users and the minimum fire resistance requirements to be met by the main building elements used to bring the whole construction up to the fire stability level specified in **Art. 4.3.2.1.** so that the whole construction meets the conditions of correlation between the location, the category of the above-ground multi-purpose crowded room and the maximum simultaneous user capacity allowed.

(3) When the building portions of crowded rooms are constituted in separate functionally independent fire compartments in high or very high buildings, the performance conditions specific to these types of buildings will also be met, ensuring that the most stringent conditions of durability laid down in the legislation for those types of buildings are met.

### **4.3.3. LIMITING THE SPREAD OF FIRES**

**Article 4.3.3.1. (1)** Within the fire or functional compartments of crowded rooms of any destination, rooms of high fire risk or holding switchgear or objects of particular importance shall be separated from the rest of the building by walls and floors whose resistance to fire shall be established according to the density of the heat load (q), in accordance with the provisions of **Article 2.3.1.2.** and **Table 5** and the importance of goods in adjacent rooms.

(2) Functionally necessary technical cabins (control, sound, lights) may have gaps protected with minimum fire resistant glazing to the agglomerated room **EI 60** or fire resistant shutters **EI 60** or sprinkler curtains with minimum operation **60** minutes, walls **EI 120** and floors **EER 120** in all cases where these booths are separated from the rest of the building in the same way as the crowded room.

(3) Separation elements inside the building and fire or functional compartments of the building with crowded rooms shall also meet the conditions determined by the heat load density (q) and the provisions of Table 102.

**Table102: Separation elements inside the building and fire or functional compartments of buildings with crowded rooms**

<b>Cu</b>	<b>Purpose of the element</b>	<b>Fire stability</b>	<b>Minimum conditions</b>	<b>Remarks</b>
-----------	-------------------------------	-----------------------	---------------------------	----------------

rre nt No		level of the building	for resistance (minutes) and reaction to fire		
			walls	floors	
1.	Intermediate floor levels arranged inside crowded rooms (loggias, balconies, mezzanines, platforms, etc.)	I, II, III	-	REI* A1, A2, s1, d0	* The conditions of the level of fire stability provided for the construction according to Table 2 shall be complied with
2.	Elements separating rooms accessible to the public in multi-purpose halls, theatres, cinemas, exhibitions, shops, shopping centres and complexes, etc., from the rest of the building (excluding basement floors)	I	EI 120 A1,A2- s1,d0	REI 90 A1, A2, s1, d0	For their common functional circulation and escape routes, the fire performance requirements for walls, doors and floors separating horizontal and vertical functional circulation and escape routes shall be complied with, unless the building in which the crowded room is arranged imposes more restrictive requirements.
		II		REI 60 A1, A2, s1, d0	
		III	EI 60 A1, A2, s1, d0	REI 45 A1, A2, s1, d0	
3.	Floors above the basement or attic, in rooms accessible to the public and their common functional circulation and escape routes, and in workshops	I, II	-	REI 180 A1, A2, s1, d0	In catering halls, may be REI 60, except for floors over car parks and storage of combustible materials
		III	-	REI 120 A1, A2, s1, d0	
4.	Separation elements between the stores of combustible materials and/or substances associated with the crowded room and the rest of the construction	I, II, III	minimum EI180 A1, A2, s1, d0	minimum REI 120 A1, A2, s1, d0	Functional communication gaps are protected with minimum elements EI <sub>2</sub> 90-C3S <sub>200</sub>

Note:

‘-’ = no fire performance

**Article 4.3.3.2.** Walls and floors separating enclosed spaces for the parking of cars from buildings or parts of buildings with crowded rooms, whatever their purpose, must have a minimum fire resistance of **EI/REI 240** for walls and **REI 180** for floors. Only functional circulation and exhaust openings, protected with buffer rooms, ventilated under overpressure and provided with fire-resistant and smoke-tight doors **EI<sub>2</sub> 90-C5S<sub>200</sub>** are permitted in these parking partitions.

#### 4.3.4. CONSTRUCTIVE ASSEMBLIES

##### 4.3.4.1. General provisions

**Article 4.3.4.1.1. (1)** The interior decorative elements and finishes, as well as the thermal and acoustic treatments and insulations of the crowded rooms must be of reaction to fire class **B-s1d0 and B<sub>FL</sub>-s1** minimum respectively, composed according to the provisions of the Rules.

**(2)** The continuity of the gaps between the thermal or acoustic finishes or treatments and their supporting elements (walls, parapets or floors) must be interrupted by diaphragms (which may be made of the same materials), in cells of a maximum size of **3 x 3 m**, so as to avoid the formation of currents conducive to the development of fires.

**Article 4.3.4.1.2. 1.** In crowded rooms and their ancillary spaces to which the public has access, ceilings (self-supporting or suspended) which are solid (with a continuous non-removable surface) shall be **EI 30 (a ↔ b)**. Ceilings with a discontinuous/modular surface of the perforated, lamellar, honeycomb or grill type shall have fire-resistant suspension elements and assemblies **R 30**.

**(2)** The continuity of the space between the suspended ceiling and the load-bearing floor shall be interrupted by continuous diaphragms of not less than **DH 30**, arranged not more than **30 m** apart in two perpendicular directions, where the space between the suspended ceiling and the load-bearing floor is not equipped with an automatic sprinkler system. In all cases, account shall be taken of the provisions of **Article 8.1.2**.

**Article 4.3.4.1.3. (1)** Crowded rooms with any purpose, as well as the storage rooms related to them with a useful area greater than **36 m<sup>2</sup>** and a thermal load greater than **105MJ/m<sup>2</sup>** shall be provided with exhaust systems for smoke and hot gases by natural-organized draught or by mechanical ventilation, according to the provisions of the standard and specific technical regulations. The total useful/aerodynamic area of the free area of devices with automatic smoke discharge aperture in the event of organised natural fire, shall be at least **1 %** from the surface of the floor coverings. When smoke exhaust is provided by mechanical ventilation, the provisions of the Rule and/or technical regulations shall be complied with.

**(2)** The total useful/aerodynamic surface of the free area of devices with automatic aperture for the evacuation of smoke and hot gases in the event of fire by organised natural draught, shall be at least **1 %** from the area of the crowded room.

**(3)** When smoke evacuation is provided by mechanical ventilation, the provisions of the relevant technical regulations and regulations shall be complied with.

**Article 4.3.4.1.4. (1)** Self-opening devices (vents) for the evacuation of smoke and hot gases in the event of fire shall be provided in the upper third of the hall (room) and shall be distributed as evenly as possible over the protected area. They may communicate directly with the outside or through smoke vents with a cross-section equivalent to that of the exhaust vents.

**(2)** Garbage cans provided for smoke manifold pipes in the event of fire will be made of materials **A1, A2s1d0** and shall have minimum fire resistant walls **EI 30** inside the room, **EI/REI 90** when passing through other destinations, and smoke extraction tubing guides as a minimum **EI/REI 180**. In all cases where piping garbage cans pass through other destinations, their access doors (hatches) will be of material **A1, A2s1d0** with fire resistance of not less than half of the fire resistance of walls, but minimum **EI45**.

**(3)** Automatic smoke evacuation devices shall also be operated by manual controls, easily accessible from the room and from the emergency service room.

**(4)** The rooms from which smoke is evacuated in the event of fire shall be provided with air inlets arranged at their bottom (near the floor), in accordance with the provisions of the legislation.

**(5)** Garbage cans provided for installations (excluding those provided for in **paragraph 2**) will fulfil the conditions of **Article 2.4.11.2 paragraphs 2, 1, 4 and 5**.

#### **4.3.4.2. Specific provisions**

**Article 4.3.4.2.1. (1)** Theatres with more than **600** seats and a stage will have the stage and its appurtenances (pockets, storerooms, workshops, performers' rooms, etc.) separated from the auditorium by minimum **EI/REI 240** fire-resistant walls and minimum **REI 120** fire-resistant floors, and the functional communication portal gap between auditorium and stage will be protected by **EI90** safety curtains. In arena theatres only the annexes are separated.

**(2)** Compared to other spaces to which the public has access (foyers, hallways, corridors, vestibules, etc.), the separation of the stage and its annexes is made with fire-resistant walls minimum **EI/REI 180** and fire-resistant floors minimum **REI 90**.

**(3)** Where stages are up to **50 m<sup>2</sup>** in size, performers' rooms may have doors communicating directly with the hall or stage.

**(4)** In the **EI/REI 240** fire resisting walls separating the theatre from the stage, two functional circulation openings (one on each side of the portal), protected with **EI<sub>2</sub>90-C5S<sub>200</sub>** fire and smoke-tight doors or protected, overpressure ventilated buffer rooms with **EI<sub>2</sub> 45-C5S<sub>200</sub>** fire and smoke-tight doors, may be provided outside the portal gap.

**(5)** In halls with a safety curtained doorway to the stage, the functional access routes between the stage and the rooms for reflectors, boxes, stage management, etc. communicating freely with the room shall be protected by protected, overpressure-ventilated buffer rooms with minimum **EI/REI 120** fire-resistant walls and minimum **REI 120** fire-resistant floors with **EI<sub>2</sub> 90-C5S<sub>200</sub>** fire-resistant and smoke-tight doors.

**Article 4.3.4.2.2. (1)** Walls and floors separating the stage and stage pockets from their appurtenances shall have a minimum fire resistance of **EI/REI 90** for walls and **REI 90** for floors.

**(2)** Operating gaps in the walls separating the scene and pockets of the scene from their attachments (workshops, cabins, offices, etc.), including those in walls separating the functional traffic routes and associated evacuations, shall be protected by fire resistant and smoke tight doors **EI<sub>2</sub> 45-C5S<sub>200</sub>**.

**(3)** The floors of artists' rooms and combustible material stores located under the stage must have a minimum fire resistance of **REI 90** for booths and a minimum of **REI 180** for stores.

**(4)** The walls separating the combustible material storerooms and the annexed workshops at high fire risk from the rest of the theatre building shall be fire resistant to a minimum of **EI/REI 240** and without gaps other than those strictly necessary for functional circulation, protected by fire resistant and smoke tight doors to a minimum of **EI<sub>2</sub> 90-C5S<sub>200</sub>**.

**(5)** The roof of the stage and the structures for the resistance of the catwalks and stage gratings can be made of **A1** or **A2-s1d0** materials, fire resistant **R 15**.

**(6)** Access openings from the building to the stage catwalks are protected with fire resistant and smoke tight doors minimum **EI<sub>2</sub> 90-C5S<sub>200</sub>**.

**(7)** The gratings of the gangways can be made of materials of reaction to fire class **A1, A2-s1d0** or **B-s1d0**.

**(8)** Floors separating the scene or pockets of the scene from other rooms above them shall be at least fire-resistant **REI 120**.

**Article 4.3.4.2.3. (1)** The projection of nitrocellulose-based films must be made from specially equipped booths when more than one non-flammable film projection machine (safety film) or digital projection machine is used, and regardless of the number of machines when projecting nitrocellulose-based films.

**(2)** The walls and floors of the projection cab based on nitrocellulose film with more than one projector of films and bearings of the projection cab shall be fire-resistant as a minimum **EI/REI 90** for walls, and **REI 60** for floors.

**(3)** The projection booth for nitrocellulose film with more than one projection device must not communicate directly with the room in which the audience is located except through projection and observation windows, sealed smoke-tight with glazing and protected by **EI 30** shutters, which, when closed in case of fire, automatically switch on the lighting in the room.



(4) If incandescent lamps or gas-discharge lamps of less than **2000 W** are used for the projection of safety films, the projection booth may communicate with the room in which the audience is located through fire-resistant and smoke-tight doors **EI<sub>2</sub> 30-C5 S<sub>a</sub>**, and the projection booth must not be protected by **EI 30** shutters unless they exceed **0.16 m<sup>2</sup>**.

(5) Communication of the safety film projection booth and its annexes with the functional circulation and escape routes of the public shall be ensured only through protected buffer rooms.

(6) The doors of the projection booth, of the reel rooms and electrical switchgear rooms as well as those of the buffer room through which they communicate with the rest of the building, shall be fire resistant and smoke tight minimum **EI<sub>2</sub> 45-C5 S<sub>a</sub>**.

(7) Digital projection booths with more than one film projection apparatus shall be separated from the rest of the building by minimum fire-resistant walls **EI/REI 60** and minimum fire-resistant floors **REI 60** and the doors for communication with the rest of the building will be fire-resistant and smoke tight **EI<sub>2</sub> 30-C5 S<sub>a</sub>**.

**Article 4.3.4.2.4.** No rooms for other purposes are planned or provided above the stages of the theatres.

**Article 4.3.4.2.5.** Theatres with more than **600** seats and a stage will be provided with:

a) safety curtains between the stage and the room, fire resistant to a minimum of **EI 90**. Safety curtains must be capable of being lowered by automatic and manual controls, locally or remotely, within **40** seconds.

b) an emergency service room of its own, which shall have easy and safe access from the outside in the event of fire and access to the stage and rooms where fire manoeuvres or interventions are required, where such services are mandatory;

c) fire access and intervention possibilities to the upper parts of the stage, to the stage level and to the stage basement via closed interior stairs or open exterior stairs, and the access openings shall be protected with fire resistant and smoke-tight doors minimum **EI<sub>2</sub> 45-C5S<sub>200</sub>**.

**Article 4.3.4.2.6. (1)** Stages with safety curtains, stage pockets with an area of more than **100 m<sup>2</sup>** and orchestra pits with more than **50** seats must have two exits separate from the theatre hall, and on stages without safety curtains, one of the exits may be through the theatre hall. In arena rooms, public evacuation routes are also evacuation routes for actors.

(2) The escape routes from balconies and lobbies in theatres, from audience service rooms, and from at least one of the overflow rooms for more than **100** persons in any crowded auditorium shall have separate routes from the auditorium.

(3) The stage pockets and storerooms, will have at least one escape route provided separately from the stage.

**Article 4.3.4.2.7. (1)** Stages with a surface area of more than **150 m<sup>2</sup>** and their pockets with a height of more than **10 m** shall be provided with smoke and hot gases evacuation in case of fire by natural-organised draught, with smoke evacuation devices (opaque or transparent) located at the upper part of the stage (above the grates), with a total free useful/aerodynamic area of at least **5%** of the floor area or by mechanical ventilation.

(2) Smoke and hot gas exhaust devices in the event of fire in stages with a surface area of more than **150 m<sup>2</sup>** and their pockets shall be automatically operated and manually operated from easily accessible places and from the emergency services set up in accordance with specific regulations.

#### **4.3.5. ESCAPE ROUTES FOR USERS IN CASE OF FIRE**

**Article 4.3.5.1. (1)** For the evacuation of users of crowded rooms, it is mandatory to provide at least two distinct and judiciously distributed escape routes for:

a) each level of the crowded rooms as well as the levels of valves, lakes and balconies for more than **100** users;

b) foyers, catering, cloakrooms and other public service rooms with an area greater than **200 m<sup>2</sup>**.

(2) Crowded rooms with a maximum simultaneous capacity of more than **600** users will have a minimum of three escape routes.

(3) In crowded auditoriums with stages or podiums, the evacuation circulation shall be organised in such a way that the user audience does not move for evacuation in the direction of the stage or podium, or the evacuation of the audience is via the stage or podium, except in situations where spectator seating is provided on the stage or podium.

(4) The gauges of escape passages inside the crowded rooms shall correspond to the number of pass-through units (flows) to be discharged through them.

**Article 4.3.5.2.** The fire performance of walls, doors and partitions of enclosed stairwells in buildings with **S1** above-ground crowded rooms of normal height shall comply with Table 103.

**Table103: Fire behaviour of walls, doors and partition boards of closed stairwells in buildings with crowded rooms of type S1 above ground with ordinary heights**

Fire stability level	Permitted reaction to fire levels in closed stairways				
	Walls		Floors (separating the staircases from the rest of the construction)		Doors (except for crowded rooms)
<b>I</b> <i>h</i> ≥ 28m	<b>EI/REI 180</b>	<b>A1 or A2-s1d0</b>	<b>REI 120</b>	<b>A1 or A2-s1d0</b>	<b>EI<sub>2</sub> 90 - C5 S<sub>200</sub></b>
<b>II</b>	<b>EI/REI 180</b>	<b>A1 or A2-s1d0</b>	<b>REI 120</b>	<b>A1 or A2-s1d0</b>	<b>EI<sub>2</sub> 60 - C5 S<sub>200</sub></b>
<b>II (+)</b>	<b>EI/REI 120</b>	<b>A1 or A2-s1d0</b>	<b>REI 90</b>	<b>A1 or A2-s1d0</b>	<b>EI<sub>2</sub> 60 - C5 S<sub>200</sub></b>
<b>III</b>	<b>EI/REI 90</b>	<b>A1 or A2-s1d0</b>	<b>REI 60</b>	<b>A1 or A2-s1d0</b>	<b>EI<sub>2</sub> 45 - C5 S<sub>200</sub></b>
<b>III (+)</b>	<b>EI/REI 60</b>	<b>A1 or A2-s1d0</b>	<b>REI 45</b>	<b>A1 or A2-s1d0</b>	<b>EI<sub>2</sub> 30 - C5 S<sub>200</sub></b>

Notes:

(+) Construction works equipped with automatic sprinkler/spray fire-extinguishing systems in addition to the requirements of the specific technical regulations.

'h' = elevation of the last accessible/usable floor of the construction from the reference level

**Article 4.3.5.3.** The fire behaviour of the walls, doors and separation boards of horizontal escape routes, corridors, in buildings with crowded rooms of type **S1** above ground with normal heights, must correspond to the provisions of Table 104.

**Table104: Fire behaviour of walls, doors and separation boards of horizontal escape routes, corridors, in buildings with crowded rooms of type S1 above ground with normal heights**

Fire stability level	Permitted reaction to fire levels in corridors				
	Walls		Floors (separating the corridors from the rest of the construction of the corridors, including their outdoors to the adjacent terrain or road)	Doors (except those to closed stairwells and crowded rooms)	
<b>I</b> <i>h</i> ≥ 28m	<b>EI/REI 90</b>	<b>A1 or A2-s1d0</b>	In accordance with the provisions of Table 2 <b>point 3</b> The minimum fire resistance conditions	<b>A1 or A2-s1d0</b>	<b>EI<sub>2</sub> 60 - C5 S<sub>200</sub></b>
<b>II</b>	<b>EI/REI 90</b>	<b>A1 or A2-s1d0</b>		<b>A1 or A2-s1d0</b>	<b>E 45 - C5 Sa</b>
<b>II (+)</b>	<b>EI/REI</b>	<b>A1 or A2-s1d0</b>		<b>A1 or A2-s1d0</b>	<b>E 30 - C5 Sa</b>

Fire stability level	Permitted reaction to fire levels in corridors				
	Walls		Floors (separating the corridors from the rest of the construction of the corridors, including their outdoors to the adjacent terrain or road)	Doors (except those to closed stairwells and crowded rooms)	
	60		that the floors must meet (REI) in order to fall within the established level of fire stability.		
III	EI/REI 60	A1 or A2-s1d0		A1 or A2-s1d0	E 30 - C5 Sa
III (+)	EI/REI 45	A1 or A2-s1d0		A1 or A2-s1d0,	E 15 - C5 Sa

Notes:

(+) Construction works equipped with automatic sprinkler/spray fire-extinguishing systems in addition to the requirements of the specific technical regulations.

'h' = elevation of the last accessible/usable floor of the construction from the reference level

**Article 4.3.5.4.** The fire behaviour of the walls, doors and separation boards of horizontal escape routes, hallways, in buildings with crowded rooms of type **S1** above ground with normal heights, must correspond to the provisions of Table 105.

**Table 105: Fire behaviour of walls, doors and separation boards of horizontal escape routes, hallways, in buildings with crowded rooms of type S1 above ground with normal heights**

Fire stability level	Admissible fire behaviour levels in hallways				
	Walls		Floors (that separate the hallways from the rest of the building, including their exits to the outside at the level of the land or the adjacent roadway)	Doors (except those to closed stairwells and crowded rooms)	
I h ≥ 28m	EI/REI 120	A1 or A2-s1d0	In accordance with the provisions of Table 2 <b>point 3</b> The minimum fire resistance conditions that the floors must meet (REI) in order to fall within the established level of fire stability.	A1 or A2-s1d0	EI <sub>2</sub> 60 - C5 S <sub>200</sub>
II	EI/REI 90	A1 or A2-s1d0		A1 or A2-s1d0	EI <sub>2</sub> 45 - C5 Sa
II (+)	EI/REI 60	A1 or A2-s1d0		A1 or A2-s1d0	EI 30 - C5 Sa
III	EI/REI 60	A1 or A2-s1d0		A1 or A2-s1d0	E 30 - C5 Sa
III (+)	EI/REI 45	A1 or A2-s1d0		A1 or A2-s1d0	E 15 - C5 Sa

Notes:

(+) Construction works equipped with automatic sprinkler/spray fire-extinguishing systems in addition to the requirements of the specific technical regulations.

'h' = elevation of the last accessible/usable floor of the construction from the reference level

**Article 4.3.5.5.** The fire performance of walls, doors and partitions of enclosed stairwells in buildings with **S2** above-ground crowded rooms of normal height shall comply with Table 106.

**Table 106: Fire behaviour of walls, doors and partition boards of closed stairwells in buildings with crowded rooms of type S2 above ground with ordinary heights**

Fire stability level	Permitted reaction to fire levels in closed stairways				
	Walls		Floors (separating the staircases from the rest of the construction)	Doors (except for crowded rooms)	
I h ≥ 28m	EI/REI 180	A1 or A2-s1d0	REI 120	A1 or A2-s1d0	EI <sub>2</sub> 60 - C5 S <sub>200</sub>

Fire stability level	Permitted reaction to fire levels in closed stairways				
	Walls		Floors (separating the staircases from the rest of the construction)		Doors (except for crowded rooms)
<b>II</b>	<b>EI/REI 180</b>	<b>A1 or A2-s1d0</b>	<b>REI 120</b>	<b>A1 or A2-s1d0</b>	<b>EI<sub>2</sub> 45 - C5 S<sub>200</sub></b>
<b>II (+)</b>	<b>EI/REI 120</b>	<b>A1 or A2-s1d0</b>	<b>REI 90</b>	<b>A1 or A2-s1d0</b>	<b>EI<sub>2</sub> 45 - C5 S<sub>200</sub></b>
<b>III</b>	<b>EI/REI 90</b>	<b>A1 or A2-s1d0</b>	<b>REI 60</b>	<b>A1 or A2-s1d0</b>	<b>EI<sub>2</sub> 30 - C5 S<sub>200</sub></b>
<b>III (+)</b>	<b>EI/REI 60</b>	<b>A1 or A2-s1d0</b>	<b>REI 45</b>	<b>A1 or A2-s1d0</b>	<b>EI<sub>2</sub> 30 - C5 S<sub>200</sub></b>

Notes:

(+) Construction works equipped with automatic sprinkler/spray fire-extinguishing systems in addition to the requirements of the specific technical regulations.

'h' = elevation of the last accessible/usable floor of the construction from the reference level

**Article 4.3.5.6.** The fire behaviour of the walls, doors and separation boards of horizontal escape routes, corridors, in buildings with crowded rooms of type **S2** above ground with normal heights, must correspond to the provisions of Table 107.

**Table107: Fire behaviour of walls, doors and separation boards of horizontal escape routes, corridors, in buildings with crowded rooms of type S2 above ground with normal heights**

Fire stability level	Permitted reaction to fire levels in corridors				
	Walls		Floors (separating the corridors from the rest of the construction of the corridors, including their outdoors to the adjacent terrain or road)	Doors (except those to closed stairwells and crowded rooms)	
<b>I</b> <b>h ≥ 28m</b>	<b>EI/REI 90</b>	<b>A1 or A2-s1d0</b>	In accordance with the provisions of Table 2 <b>point 3</b> The minimum fire resistance conditions that the floors must meet ( <b>REI</b> ) in order to fall within the established level of fire stability.	<b>A1 or A2-s1d0</b>	<b>E 45 - C5 Sa</b>
<b>II</b>	<b>EI/REI 90</b>	<b>A1 or A2-s1d0</b>		<b>A1 or A2-s1d0</b>	<b>E 30 - C5 Sa</b>
<b>II (+)</b>	<b>EI/REI 60</b>	<b>A1 or A2-s1d0</b>		<b>A1 or A2-s1d0</b>	<b>E 30 - C5 Sa</b>
<b>III</b>	<b>EI/REI 60</b>	<b>A1 or A2-s1d0</b>		<b>A1 or A2-s1d0</b>	<b>E 15 - C5 Sa</b>
<b>III (+)</b>	<b>EI/REI 45</b>	<b>A1 or A2-s1d0</b>		<b>A1 or A2-s1d0</b>	<b>E 15 - C5 Sa</b>

Notes:

(+) Construction works equipped with automatic sprinkler/spray fire-extinguishing systems in addition to the requirements of the specific technical regulations.

'h' = elevation of the last accessible/usable floor of the construction from the reference level

**Article 4.3.5.7.** The fire behaviour of the walls, doors and separation boards of horizontal escape routes, hallways, in buildings with crowded rooms of type **S2** above ground with normal heights, must correspond to the provisions of Table 108.

**Table108: Fire behaviour of walls, doors and separation boards of horizontal escape routes, hallways, in buildings with crowded rooms of type S2 above ground with normal heights**

Fire stability level	Admissible fire behaviour levels in hallways				
	Walls		Floors (that separate the hallways from the rest of the building, including their exits to the outside at the level of the land or the adjacent roadway)	Doors (except those to closed stairwells and crowded rooms)	
<b>I</b> $h \geq 28m$	<b>EI/REI 120</b>	<b>A1 or A2-s1d0</b>	In accordance with Table 2 <b>point 3</b> The minimum fire resistance conditions that the floors must meet ( <b>REI</b> ) in order to fall within the established level of fire stability.	<b>A1 or A2-s1d0</b>	<b>E 45 - C5 Sa</b>
<b>II</b>	<b>EI/REI 90</b>	<b>A1 or A2-s1d0</b>		<b>A1 or A2-s1d0</b>	<b>E 45 - C5 Sa</b>
<b>II (+)</b>	<b>EI/REI 60</b>	<b>A1 or A2-s1d0</b>		<b>A1 or A2-s1d0</b>	<b>E 30 - C5 Sa</b>
<b>III</b>	<b>EI/REI 60</b>	<b>A1 or A2-s1d0</b>		<b>A1 or A2-s1d0</b>	<b>E 30 - C5 Sa</b>
<b>III (+)</b>	<b>EI/REI 45</b>	<b>A1 or A2-s1d0</b>		<b>A1 or A2-s1d0</b>	<b>E 15 - C5 Sa</b>

Notes:

(+) Construction works equipped with automatic sprinkler/spray fire-extinguishing systems in addition to the requirements of the specific technical regulations.

'h' = elevation of the last accessible/usable floor of the construction from the reference level

**Article 4.3.5.8.** The standard number of users per evacuation unit (flow) ( $U_f$ ) in crowded rooms is specified in Table 109.

**Table 109: Standardized number of users per unit of passage (flow) of evacuation ( $U_f$ ) in crowded rooms**

Item No	The type of crowded room and the fire stability level of the building	Expected number of users per exhaust passage (flow) unit ( $U_f$ )	
1.	Congested hall type S1 and fire stability level:	<b>I</b>	<b>60 (80)*</b>
		<b>II</b>	<b>50 (70)*</b>
		<b>III</b>	<b>35 (50)*</b>
		<b>IV and V</b>	<b>25</b>
2.	Congested hall type S2 and fire stability level:	<b>I</b>	<b>75(110)*</b>
		<b>II</b>	<b>70 (100)*</b>
		<b>III</b>	<b>50 (75) *</b>
		<b>IV</b>	<b>35</b>
		<b>V</b>	<b>25</b>

Note:

\* = The values in brackets refer to the evacuation passage units (flows) within the crowded room, along the route from the furthest point to the nearest exit door of the crowded room.

**Article 4.3.5.9.** The maximum allowable escape lengths on the routes travelled by users on the escape routes (from the furthest point to the nearest exit door of the crowded room being the **inner** escape route) of the crowded rooms are specified in Table 110.

**Table 110: Maximum permitted exhaust lengths for crowded rooms**

Crowded room category	Fire stability level of the building	Maximum permitted exhaust lengths		
		from the farthest point to the nearest exit door of the crowded room	from the door of the crowded room to a staircase, protected clearance or outside, when the evacuation is done:	
			in two different directions	in a direction (dead-end corridor)
		metres	metres	metres
Congested hall type S1	I	48	40	25
	II	40	35	20
	III	32	25	15
	IV	24	16	12
	V	16	10	10
Congested hall type S2	I	60	40	25
	II	50	35	20
	III	40	25	15
	IV	30	16	12
	V	20	10	10

Note:

a) Escape routes through foyers, hallways and windfangs of the crowded room are not taken into account when determining the standard evacuation length, if the foyers and hallways have ensured the minimum fire safety conditions established for the respective crowded room, including smoke evacuation systems.

**Article 4.3.5.10. (1)** The placement of the furniture in crowded rooms is done in such a way as to create passages with appropriate widths, through which the users of the room can reach the exits.

(2) In crowded rooms with seats on armchairs, chairs or benches, overpasses can be provided on the passages between the seat packages, if they:

- a) rise automatically and remain in this position when they are not in use, leaving free the width of the passage resulting from the calculation;
- b) being lowered, a passage with a width of at least **80 cm** remains free.

**Article 4.3.5.11.** On the exit passages between the rows of seats, steps are allowed only perpendicular to them (not along them).

**Article 4.3.5.12. (1)** In performance halls, auditoriums, concert halls, multi-purpose halls and similar ones, the maximum number of seats in a row is determined according to the level of fire stability of the building and the way in which users are evacuated from the row, according to the provisions from Table 111.

**Table 111: Maximum number of seats in a row of seats**

Evacuation mode of users in a row of seats	Fire stability level of the building		
	I and II	III	IV and V
	Number of seats in a row		
On one end of the row	25	14	10*
On both ends of the row	40	25	20

Note:

\*) – In the permitted cases, in crowded rooms in buildings with fire stability level IV or V that are not equipped with an internal fire extinguishing system, evacuation of the rows of seats at both ends is mandatory.

(2) The number of seats in a row shall not be limited in crowded rooms in buildings of fire integrity level I or II if doors are provided in the side walls of the room so arranged that there is an exit door at each end of a group of four rows of seats.

(3) The clearance between rows of seats must be at least **45 cm**.

**Article 4.3.5.13. (1)** To ensure rapid and accident-free evacuation of users, rows of chairs, benches and desks in crowded rooms are secured to the floor so that they do not tip over in a panic.

(2) In multipurpose rooms it is recommended that seats are joined together on the strings and rows. Each string or row of seats shall be securely attached to the two ends of the floor or walls, or held together with the other rows so that it becomes a packet. In all cases, the fixing bars perpendicular to the rows of seats and applied at floor level shall have no more than **20 mm** thickness and profile rounded.

(3) The boxes in the performance halls, exhibitions and dance halls can have a maximum of **25** mobile chairs.

(4) In meeting rooms with a maximum capacity of **200** seats, the rows of seats and benches may not be fixed to the floor.

**Article 4.3.5.14. (1)** The placement of furniture in crowded rooms is done in such a way as to ensure access and circulation at the exits from the room, through passages with widths determined by calculation.

(2) When placing the furniture in crowded rooms with seats at tables, passages with standardized widths determined by calculation must be ensured and through which users can escape in case of fire.

**Article 4.3.5.15.** It is forbidden to use drapes, curtains, etc., which may interrupt the escape routes of the users of crowded rooms.

**Article 4.3.5.16. (1)** In buildings with congested halls, escalators made according to the provisions of **Art. 2.5.6.3.3.** can be provided, provided that there are also escape routes for users through closed stairs.

(2) Regardless of ramp width, escalators can be considered to provide the passage of a single unit (flow) of evacuation passage.

**Article 4.3.5.17. (1)** Doors along the evacuation route of users of the crowded rooms shall open in the direction of evacuation to the outside, be fitted with an anti-panic bar and shall have no projections likely to impair passage.

(2) On the exterior doors and those in the walls that separate the crowded room from other functions of the building, latching systems can be used, easily operated by means of the anti-panic bar.

**Article 4.3.5.18. (1)** The width of the escape stairs in the conditions where the users on different levels/elevations of the crowded room can observe the fire at the same time and can simultaneously head towards the stairs, is determined by the number of escape passage units (flows) coming from the level more congested, to which is added for each of the other levels/elevations, the width necessary for the evacuation of **25%** of the users on that level.

(2) The width of the user evacuation doors at the level of the land or the surrounding roadway must ensure the passage of the total number of evacuation passage units (flows), which come through the internal stairs and all those on the ground floor. The width of access and escape doors in the event of fire shall be increased by **25 %** in relation to the width determined by the calculation.

**Article 4.3.5.19. (1)** Common horizontal circulations that do not have direct windows to the outside, are provided with smoke and hot gas exhaust systems in case of fire or are pressurized.

(2) Stairwells must be provided with smoke and hot gas exhaust systems or SPD differential pressure systems.

(3) By way of exception from **paragraph 2**, naturally lit and ventilated stairwells through windows with movable meshes arranged on each level are provided with the evacuation of smoke

and hot gases through the movable meshes located in the upper third of the external walls on the last level of the stairwell (and air intake according to standard provisions) with manual operation from each level, from the main access in the staircase and from the Private Fire Service room, as appropriate and with automatic operation if the building is equipped with a fire detection, signalling and alarm system.

**Article 4.3.5.20. (1)** The projection booth for safety film or digital projection and their annexes will have access to an escape route, which may be shared with the audience but without passing through the hall. At the projection booths for nitrocellulose-based film, a second escape route is provided, independent of the audience.

**(2)** The access gap in the projection booths and their annexes from the public escape routes must be protected with a fire-resistant and smoke-tight door according to **Art. 4.2.4.2.3**.

**Article 4.3.5.21. (1)** The above-ground internal evacuation stairs of the users of crowded rooms can have direct ramps to the basement only when they ensure their circulation to rooms and spaces intended for the public user (separated from other functions arranged in the basement according to the Rules).

**(2)** The external stairs provided for the evacuation of users of crowded rooms must be fire resistant at least **R 15** fire reaction class **A1 or A2-s1d0**, protected and dimensioned according to the Rules and with a maximum slope of **1:2**.

**(3)** Covered inclined planes can be used as escape exits at the level of the land or of road traffic, if they meet their specific conditions.

**(4)** Interior courtyards and spaces between buildings may be taken into account for the evacuation of users in the event of fire when they are protected from the effects of fire and have sufficient width for the passage of the number of escape passage units (flows) resulting from the calculation, but not less than **10 m**.

#### **4.3.6. FIRE ACCESS, INTERVENTION AND RESCUE CONDITIONS**

**Article 4.3.6.1.** In buildings with congested halls, access and intervention from the outside for emergency vehicles are ensured, at least on two sides, so as to ensure the access and intervention of fire extinguishing vehicles in case of fire, at least on **50%** of the perimeter of the external walls.

**Article 4.3.6.2. (1)** Buildings with crowded rooms will have access from public roads and appropriate possibilities to carry out fire-fighting and rescue operations for users in the event of fire.

**(2)** Outdoor platforms for the parking of vehicles in the vicinity of buildings must be located outside the clear gauge necessary for the evacuation of users and the access, circulation and intervention of vehicles to the glazed facades of the building and water supply sources.

**Article 4.3.6.3.** In accordance with the maximum simultaneous capacity of the building with crowded rooms, account must also be taken of the provisions of **Article 2.6.7, paragraph 1**.

**Article 4.3.6.4. (1)** In the case of building portions related to crowded rooms from constructions with other purposes, which can be constituted into distinct, functionally independent fire compartments, delimited from the rest of the building according to the normative provisions, for each separate fire compartment properly sized road access roads are provided for the circulation and location of firefighting and rescue vehicles, at least on two sides, so as to ensure the access and intervention of firefighting vehicles, at least on **50%** of the perimeter of the external walls.

**(2)** In accordance with the maximum simultaneous capacity of the building with crowded rooms, account must also be taken of the provisions of **Article 2.6.7, paragraphs 1 and 2**.



### **4.3.7. EQUIPPING BUILDINGS WITH FIRE-FIGHTING INSTALLATIONS AND APPLIANCES**

**Article 4.3.7.1. (1)** Buildings with crowded rooms shall be equipped with fire-fighting facilities and means, as well as fire detection, signalling and alarm installations, in accordance with the provisions of the specialised technical regulations.

**(2)** Civil buildings with crowded rooms are equipped with fire extinguishers, ensuring a portable fire extinguisher with minimum extinguishing performance **21A** and **113B** for a maximum unfolded area of **200 m<sup>2</sup>**, but at least two fire extinguishers on each level of the building.

## **CHAPTER 5**

### **5. PERFORMANCE SPECIFIC TO UNDERGROUND CIVILIAN BUILDINGS AND UNDERGROUND PORTIONS (SUBSOILS) OF ABOVE-GROUND CIVIL (PUBLIC) BUILDINGS**

#### **5.1. COMMON PERFORMANCE CONDITIONS OF BUILDINGS (Fire risk and fire stability level of the construction)**

**Article 5.1.1.** Independent underground civil buildings consist of structures with various functions (shopping centres, art galleries, discotheque, bars, meeting rooms or shows, food, services, etc.), under the share of the surrounding land. They do not consist of sub-soils of above-ground buildings.

**Article 5.1.2. (1)** Independent underground civil buildings will have level **I** or **II** fire stability, and the area of the fire compartment will be limited to **3,500 m<sup>2</sup>**, without the possibility of an increase.

**(2)** The arrangement of the functions and the fire safety measures provided shall ensure that the propagation of smoke and fire inside, as well as to neighbourhoods, is limited.

**Article 5.1.3.** Independent civil (public) underground buildings shall be designed and carried out in accordance with the specific legislation (Rules for the design of underground public buildings NP 25), having regard also to the provisions of this chapter, and those pooled into above-ground civil buildings (their subsoils), in accordance with the provisions of these Rules.

**Article 5.1.4.** The underground portions (subsoils) of the above-ground civil (public) buildings shall comply with the conditions for classification in the fire stability level of the above-ground building, in accordance with the regulatory provisions, and the specific fire risks shall be established and specified.

#### **5.2. BUILDING LOCATION AND COMPLIANCE**

**Article 5.2.1.** Independent underground buildings may be located independently or may be allotted to underground constructions or parts of building from which they are subdivided. Independent underground civilian buildings shall not be pooled.

**Article 5.2.2. (1)** In independent civil underground buildings, it is not recommended to arrange spaces or rooms with high or very high fire risks or in which substances are used and/or stored that, mixed with air, can produce mixtures with a volumetric explosion risk.

**(2)** Functions that include combustible liquids with a flammability temperature below 55°C in the declared quantities (fuel car filling stations, car service, car wash stations and similar), can be arranged in specially arranged and marked areas of the independent underground building, then when they are partitioned from the rest of the underground building and meet the fire safety conditions established in the regulations and in the specific technical regulations.

**Article 5.2.3. (1)** Independent underground civil buildings of fire stability level **II** will not have more than two underground levels, and those of fire stability level **I** will have a maximum of three levels.

**(2)** The number of levels of independent underground civil buildings of level **I** fire stability is not regulated, if the fire resistance of the floors is at least **REI 180**, and that of the beams at least **R180**.

**Article 5.2.4.** Underground civil buildings and their rooms, as well as the underground portions (basements) of above-ground civil (public) buildings will have the fire risks established and specified, as well as the maximum simultaneous user capacities.

### 5.3. LIMITING THE SPREAD OF FIRES

**Article 5.3.1.** Rooms with a medium, high and very high risk of fire in independent underground buildings as well as the underground portions (basements) of above-ground civil (public) buildings are separated from the rest of the construction by fire-resistant walls and floors according to the density of the thermal load ( $q$ ) in the adjacent spaces, corresponding to the provisions of **Art. 2.3.1.2.** and **Table 5** as well as the normative provisions. Functional circulation and exhaust gaps in partition walls with minimum fire resistance **EI/REI 180** are protected with protected buffer rooms, ventilated under pressure and equipped with fire-resistant and smoke-tight doors **EI<sub>2</sub>90-C5S<sub>200</sub>**. The protection of the gaps in the partition walls **EI/REI 60** is provided with **EI<sub>2</sub>45-C5S<sub>200</sub>** doors and the protection of the gaps in the partition walls **EI/REI 120** is provided with fire-resistant and smoke-tight doors **EI<sub>2</sub>60-C5S<sub>200</sub>**.

**Article 5.3.2. (1)** Stairwells and shafts for lifts or other vertical transport systems, including their associated machine rooms in self-contained underground civil buildings, shall be separated from the rest of the construction by fire-resistant walls and floors appropriate to the thermal load density ( $q$ ) and intended use of the adjacent spaces concerned, but at least **EI/REI 120** for walls and **REI 90** for floors respectively.

**(2)** Access gaps to shafts for lifts or other vertical transport systems and to the rooms mentioned in **paragraph 1**, as well as in closed stairwells, are protected with fire-resistant and smoke-tight doors **EI<sub>2</sub>90-C5S<sub>200</sub>** or protected buffer rooms, ventilated under pressure and provided with fire-resistant and smoke-tight doors **EI<sub>2</sub>45-C5S<sub>200</sub>**.

### 5.4. CONSTRUCTIVE ASSEMBLIES

**Article 5.4.1.** Rooms and associated technical spaces arranged in independent underground buildings shall be designed, constructed and used in accordance with the provisions of the legislation, the specific regulation (Rules for the design of underground public constructions NP 25) and the specialised technical regulations, ensuring the technical conditions to avoid fire initiation and the easy spread of smoke and fire.

**Article 5.4.2.** Construction products used in independent underground civil buildings will be of the reaction to fire class **A1, A2-s1d0**.

**Article 5.4.3. (1)** Finishing, thermal and acoustic treatments in independent underground civil buildings shall be of fire reaction class **A1** or **A2-s1d0** (including their supporting or mounting framework).

**(2)** Self-supporting or suspended ceilings in underground buildings will be fire-resistant **EI 45 (a ↔ b)**.

**(3)** The continuity of the space between the suspended ceiling and the resistance floor will be interrupted with minimum continuous diaphragms **DH 30**, arranged at a maximum of **30 m** in two perpendicular directions, when the space between the suspended ceiling and the resistance floor is not equipped with an automatic extinguishing system with sprinklers. In all cases, account shall be taken of the provisions of **Article 8.1.2**.

## 5.5. ESCAPE ROUTES FOR USERS IN CASE OF FIRE

**Article 5.5.1.** The routes provided for functional circulation and evacuation from independent underground civil buildings shall be constructed and dimensioned in such a way as to meet the conditions necessary to ensure the evacuation of users in the event of fire, in accordance with the applicable regulations and technical regulations.

**Article 5.5.2.** The functional circulation and evacuation of users in the event of fire shall be separated from the rest of the underground civil building in accordance with the provisions of Table 112.

**Table 112: Separation of functional circulation and evacuation routes for users of underground buildings**

Fire stability level of the underground civil building	Resistance and reaction to fire of separating elements (minutes)					
	corridors, hallways,			closed stairwells		
	walls	floors	Doors	walls	floors	Doors
<b>I</b>	<b>EI 120</b> <b>A1, A2-s1d0</b>	<b>REI 120</b> <b>A1, A2-s1d0</b>	<b>EI<sub>2</sub> 60 -</b> <b>C5 S<sub>200</sub></b>	<b>EI 180</b> <b>A1, A2-</b> <b>s1d0</b>	<b>REI 120</b> <b>A1, A2-</b> <b>s1d0</b>	<b>EI<sub>2</sub> 90 -</b> <b>C5 S<sub>200</sub></b>
<b>II</b>	<b>EI 90</b> <b>A1, A2-s1d0</b>	<b>REI 90</b> <b>A1, A2-s1d0</b>	<b>EI<sub>2</sub> 45 -</b> <b>C5 Sa</b>	<b>EI 120</b> <b>A1, A2-</b> <b>s1d0</b>	<b>REI 90</b> <b>A1, A2-</b> <b>s1d0</b>	<b>EI<sub>2</sub> 60 -</b> <b>C5 S<sub>200</sub></b>
<b>II (+)</b>	<b>EI 90</b> <b>A1, A2-s1d0</b>	<b>REI 90</b> <b>A1, A2-s1d0</b>	<b>EI<sub>2</sub> 45 -</b> <b>C5 Sa</b>	<b>EI 90</b> <b>A1, A2-</b> <b>s1d0</b>	<b>REI 90</b> <b>A1, A2-</b> <b>s1d0</b>	<b>EI 30 -</b> <b>C5 Sa</b>

Notes: Protected decks shall be provided with minimum:

- walls **EI/REI180**, doors **EI290 - C5S<sub>200</sub>** and floors **REI 120** on the **I** fire stability
  - walls **EI/REI120**, doors **EI260 - C5S<sub>200</sub>** and floors **REI 90** on the **II** fire stability
  - walls **EI/REI90**, doors **EI<sub>2</sub>45 - C5S<sub>200</sub>** and floors **REI 90** on the **II (+)** fire stability
- (+) Buildings equipped with automatic sprinkler/spray fire extinguishing systems in addition to the requirements of the specific technical regulations

**Article 5.5.3. (1)** The routes of the escape routes of the users of the independent civil underground buildings must be established in such a way that, through their distribution, composition, dimensioning and marking, the easy recognition of the outward evacuation direction and the easy movement of the users can be ensured.

**(2)** Functional traffic and evacuation routes of underground construction users with maximum simultaneous capacity greater than **500** users or underground spaces with maximum simultaneous capacity greater than **150** users (with the exception of parking), shall be independent

of the escape routes of constructions with another destination, and communication between them shall only be permitted through protected buffer rooms, ventilated under excess pressure.

**Article 5.5.4. (1)** Apart from escape staircases providing for the evacuation of users of a single underground level, escape staircases for users of underground civil buildings shall be enclosed in stairwells and shall have ramps separated by fire resisting walls with a minimum **EI/REI 180** for fire stability level **I** and **EI/REI 120** for fire stability level **II** (irrespective of additional equipment with automatic sprinkler systems compared to the provisions of the relevant standard).

**(2)** In underground buildings as well as in the underground portions (basements) of above-ground civil (public) buildings, escalators made in accordance with the provisions of **Art. 2.5.6.3.3.** may be provided, provided that escape routes for users are also provided by closed stairwells.

**Article 5.5.5. (1)** The evacuation routes of users of independent underground civil buildings shall respect the evacuation lengths specified in Table 113.

**(2)** The maximum permissible exhaust lengths shall be determined for the escape route travelled from the room door to the nearest entrance door to the protected buffer room, ventilated over pressure, of the stairway enclosure.

**(3)** Inside the rooms, the permissible escape length in a single direction (capped corridor) shall be provided.

**Table 113: Escape lengths in independent underground civil buildings**

Item No	Destination of the independent underground civil building	Fire stability level provided	Maximum escape length		Remarks
			in two different directions	in a direction (dead-end corridor)	
			metres	metres	
1.	Administrative, shopping centres, art galleries, discotheques, bars, meeting rooms or shows, food, services, etc.	<b>I</b>	35	20	-
		<b>II</b>	25	15	

**Article 5.5.6.** In self-contained underground civil buildings, the standard number of users per evacuation flow unit ( $U_f$ ) is **60**.

**Article 5.5.7. (1)** The evacuation of smoke and hot gases in the event of fire from civil underground buildings and rooms shall be mandatory, by means of independent systems, at:

- a)** rooms and their escape routes where more than **50** users may be present simultaneously;
- b)** rooms with a medium and high risk and an area greater than **36 m<sup>2</sup>** or rooms with a very high fire risk, regardless of their area, as well as storage rooms with a useful area greater than **36 m<sup>2</sup>** and a heat load greater than **105 MJ/m<sup>2</sup>**.

**1.** The rooms in **paragraph 1** shall be provided with exhaust systems for smoke and hot gases by means of natural-organised draught or mechanical ventilation, in accordance with the provisions of the specific technical rules and regulations. The total useful/aerodynamic area of the free area of devices with automatic smoke discharge aperture in the event of organised natural fire, shall be at least **1 %** from the surface of the floor coverings. When fuming is provided by mechanical ventilation, the provisions of the Rule and/or technical regulations shall be complied with.

## 5.6. FIRE ACCESS, RESPONSE and RESCUE CONDITIONS

**Article 5.6.1. (1)** In order to ensure adequate conditions for intervention and rescue of users in case of fire, independent underground civil buildings shall have access from public circulation and road circulation to the premises, constructed, protected and marked in accordance with the provisions of the applicable technical regulations and standards.

**(2)** Outdoor platforms for the parking of vehicles located in the vicinity of the constructions will be located outside the free gauge required for intervention and for the evacuation of users, of the access routes of special vehicles in case of fire at the construction and at the water supply sources.

**Article 5.6.2.** In order to ensure the appropriate conditions for intervention and rescue in the event of a fire, there are external accesses on two sides and properly constructed, protected and marked internal circulations.

## 5.7. EQUIPPING BUILDINGS WITH FIRE-FIGHTING INSTALLATIONS AND APPLIANCES

**Article 5.7.1. (1)** Independent civil underground buildings shall be equipped with fire-fighting facilities and means, as well as fire detection, signalling and alarm installations, in accordance with the provisions of the specialised technical regulations.

**(2)** Independent underground civil buildings are equipped with fire extinguishers ensuring a portable fire extinguisher with the minimum extinguishing performance **21A** and **113B** for a maximum developed area of **200** m<sup>2</sup>, but at least two fire extinguishers on each level of the building, according to the provisions of the standard and specific regulations.

# CHAPTER 6

## 6. PERFORMANCE SPECIFIC TO PRODUCTION AND/OR STORAGE BUILDINGS

### SECTION I

#### 6.1. Performance common to production and/or storage buildings

##### 6.1.1. GENERAL BUILDING PERFORMANCE CONDITIONS (*Fire risk, Fire stability level of the building*)

**Article 6.1.1.1. (1)** The design and construction of production and/or storage constructions shall comply with the provisions of these Rules.

**(2)** Where other technical regulations specify fire hazard categories, production/storage buildings may be so defined:

- **Fire hazard category A** (substances that may ignite or explode in contact with oxygen in the air, water or other substances or materials or liquids with a flammable vapour temperature up to 28°C, gases or vapours with a lower explosion limit up to 10%, when they can form explosive mixtures with air) and **fire hazard category B** (liquids with a flammable vapour temperature between 28-100°C, gases or vapours with a lower explosion limit of more than 10% when they can form explosive mixtures with air or fibres, dusts or powders which are released in suspension in

quantities which may form explosive mixtures with air): **the possibility of fire and volumetric explosion;**

Does not give rise to classification as a fire hazard category A and B:

- the use of solid, liquid or gaseous substances as fuels for combustion;
- leaks and releases of gases, vapours or dust which are in quantities which cannot form explosive mixtures with air.

In such cases, classification shall be made in fire hazard category C, D or E, depending on the density of the heat load and the fire hazard as a whole);

- **Fire hazard category C** (solid or liquid combustible substances and materials with vapor flammability temperature higher than 100°C): **possibility of fire/burning**, with thermal load density  $q > 105\text{MJ/m}^2$ ;

Does not trigger classification as Category C (BE2) hazard, any of the following:

- the use of solid, liquid or gaseous substances as fuels for combustion;
- the use of combustible liquids with a flammability temperature above 100°C for hydraulic controls, cooling, lubrication, filters and thermal treatments, in quantities of max. 2 m<sup>3</sup>, provided that local measures are taken to limit the spread of fire;
- the use of electrical equipment, which contains up to 60 Kg of oil per unit of equipment, as well as cable flows with less than 3.5 Kg of combustible material / ml per flow;
- the combustible materials and substances in that space, including those from machines that do not fall under point 2 or those used for the transport or storage of combustible materials, combustible packaging, pallets or shelves, if they do not exceed 105 MJ/m<sup>2</sup> in total

In the above situations, classification shall be based on the fire hazard as a whole, in category D or E of fire hazard;

- **Fire hazard category D:** existence of open fire in any form, in the absence of combustible substances (non-combustible substances or materials in a hot, molten or incandescent state, with releases of radiant heat, flames or sparks) or combustible substances and materials **with the possibility of fire/burning**, with thermal load density  $q \leq 105\text{MJ/m}^2$ ;
- **Fire hazard Category E:** existence of cold non-combustible materials or substances or combustible substances with a high moisture state, above 80%, with heat load density  $Q \leq 105\text{MJ/m}^2$ ;

**Article 6.1.1.2. (1)** Zones, rooms, fire compartments and production and/or storage buildings shall have fire risks determined and specified in accordance with the provisions of **Article 2.1.2.2.** and **Article 2.1.2.5.**

**(2)** Where combustible liquids are used or stored in production and/or storage construction, their specific fire safety measures shall also be complied with.

**(3)** At technological production and/or storage facilities located in the open air, fire risks are determined independently for each facility that has different characteristics from the point of view of fire safety and where the security conditions and performance levels corresponding to them are ensured, specifying the zones where specific protection measures are mandatory. The technological engineer must establish and delimit the dangerous zones (protection and Ex zones) and respectively equipment and endowment with safety and fire safety systems specific to the types of raw materials, finished products provided in the specialized regulations.

**Article 6.1.1.3. (1)** Depending on the fire risks determined and specified mandatorily in the documentation, the production and/or storage constructions ensure the standardized performances.

**(2)** The delimitation of zones where the specific fire safety measures required by the very high risks of fire and volumetric explosion are provided, shall be mandatory and shall consider the presence of mixtures of air with gases, vapours or dust in concentrations with explosion hazard during normal operation.

**Article 6.1.1.4. (1)** Constructions and fire compartments for production and/or storage will have determined and specified the level of fire stability ensured.

**(2)** The minimum conditions that the construction must meet in order to be included in the fire stability level, are specified in **Art. 2.1.3.2.** and in Table 3.

## 6.1.2. LOCATION AND COMPLIANCE OF BUILDINGS

**Article 6.1.2.1.** Production and/or storage buildings are located at the standard distances from neighbouring buildings, according to the provisions of **Art. 2.2.1.2.** and Table 4 or are partitioned against them with fire-resistant construction elements for the separation of fire compartments, corresponding to the fire risks and the thermal load density (**q**).

**Article 6.1.2.2.** Depending on the level of fire stability ensured, the constructed areas of the production and/or storage buildings and fire compartments (**Ac**) comply with the provisions of Table 114.

**Table 114: Correlation conditions of built-up areas (Ac) and the number of levels of constructions and above-ground fire compartments for production and/or storage**

Risk of fire	Fire stability level	Number of permitted levels	Maximum built area (Ac) of production and/or storage buildings and fire compartments (m <sup>2</sup> )		
			Ground floor	with two levels	multilevel
Very high and explosion risk	I	6	Unlimited		
	II	6	6,000	3,000	1,000
Extra High	I		Unlimited		
	II	6	Unlimited	10,000	5,000
Tall	I		Unlimited		
	II	6	Unlimited	15,000	7,500
	III	3	5,500	3,500	2,500
	IV	2	3,000	1,500	Not permitted
	V	1	1,500	Not permitted	
Medium	I - II		Unlimited		
	III	3	7,000	5,500	3,500
	IV	2	3,500	2,000	Not permitted
	V	1	1,500	Not permitted	
Small	I - II		Unlimited		
	III	3	7,800	6,500	5,000
	IV	2	3,500	2,600	Not permitted
	V	2	2,600	1,500	Not permitted

**Notes:**

**a)** Built-up areas (Ac) may increase by **100 %** in fire buildings and fire compartments equipped with automatic fire-extinguishing systems; or **25 %** for those fitted with fire detection, signalling and alarm systems with total coverage. Increases shall not be cumulated.

**b)** In two-storey above-ground production and/or storage buildings within the property boundary, where provision is made for fully enclosed fire detection, signalling and fire alarm installations, automatic fire extinguishing and smoke evacuation installations in horizontal common circulation (corridors/hallways) and

*stairwells, investors or beneficiaries may increase the fire compartment area within the limits allowed for ground floor buildings, if the floor between the ground floor and the first floor is fire resistant to a minimum of EI 120 and any technological gaps in the separating floor are protected by fire resistant elements to a minimum of EI 90 with automatic closure in case of fire*

**Article 6.1.2.3. (1)** When complying with above-ground production and/or storage constructions and fire compartments, the provisions regarding the common performances of constructions with any destination and those common and specific to above-ground production and/or storage constructions will be taken into account (**Art. 2.2.2.1. ÷ 2.2.2.4. and Art. 6.1.2.2.**).

**(2)** The production and/or storage buildings will be conformed in such a way as to meet the correlation conditions between the level of fire stability ensured (according to the provisions of **Art. 2.1.3.2.** and Table 3), the built-up area (**Ba**), the destination and the number of levels, according to the normative provisions (**Art. 6.1.2.2.**).

**Article 6.1.2.4. (1)** As far as possible, activities with high and very high fire risks shall be carried out in distinct areas of construction and those with risks of volumetric explosion at the last level of the above-ground construction of production and/or storage.

**(2)** Where activities at risk of volumetric explosion cannot be technically or functionally arranged at the last level of construction of production and/or storage, it is mandatory to ensure appropriate partitioning measures with fire resistant elements and volumetric explosion (**REI**), in accordance with the provisions of the legislation and the specific technical regulations. For activities at risk of volumetric explosion arranged technically or functionally on the terrace of the last level of production and/or storage construction, it is mandatory to ensure appropriate partitioning measures to other areas and functions with elements resistant to fire and volumetric explosion, in accordance with the applicable legislation and technical regulations.

**(3)** In the basements of production buildings, spaces with a risk of volumetric explosion can be arranged only when they are technically justified and have ensured the specific measures of protection and partition with elements resistant to fire and explosion (**REI**).

### **6.1.3. LIMITING THE SPREAD OF FIRES**

**Article 6.1.3.1. (1)** Fire compartments of production and/or storage buildings constituted in accordance with the regulatory provisions shall be separated from the rest of the construction by components appropriate to the fire risk and the density of the heat load (**q**) in adjacent rooms, in accordance with the provisions of **Article 2.3.1.2.** and **Table 5.**

**(2)** In the same way, they shall be separated from each other and parts of the construction that are classified as different fire risks.

**(3)** Within fire compartments, fire resistant horizontal and/or vertical separation elements shall be provided to prevent the slight spread of fire and smoke over large built areas.

**Article 6.1.3.2. (1)** Groupings of rooms with the same fire risk and destination shall be permitted within the following areas built in production and/or storage buildings:

- maximum of **600 sqm**, provided that the built-up area of the open space type rooms is a maximum of **75%** of that of the constructed area of the respective level for production and/or storage buildings included in level **I** of fire stability;

- maximum **400 sqm**, provided that the built-up area of the open space type rooms is a maximum of **75%** of that of the constructed area of the respective level for production and/or storage buildings included in fire stability level **II**;

- maximum **200 sqm**, provided that the built-up area of the open space type rooms is a maximum of **50%** of that of the built-up area of the respective level for production and/or storage buildings included in level **III** of fire stability.

Groupings of rooms with the same fire risk and the same destination not delimited between them assigned to the level of **IV-V** fire stability shall not be permitted in production and/or storage buildings.



(2) In constructions and fire compartments, the separation of spaces is achieved by fire-resistant walls according to the thermal load density but minimum **EI/REI 60** and, as the case may be, floors minimum **REI 60**, and functional communication gaps in them are protected with resistant closing elements fire and smoke-tight at least half of the fire resistance of the walls but at least **EI<sub>2</sub>30-C3S<sub>200</sub>**.

**Article 6.1.3.3. (1)** Technical and social annexes, laboratories and annexed workshops (except sanitary facilities) shall be separated with minimum fire resistant walls **EI/REI 90** from rooms with medium fire hazards and functional communication gaps in these bulkheads shall be protected by fire resistant and smoke tight fastenings **EI<sub>2</sub>45-C3S<sub>200</sub>**. The partition floors shall be fire resistant to a minimum of **REI 45** and any gaps in them shall be protected with fire resistant closure elements to a minimum of **EI45**.

(2) The technical and social annexes, the annexed laboratories and workshops (excluding sanitary facilities) shall be separated from rooms of high and very high fire risk with walls and boards with fire resistance appropriate to the risks and densities of heat loads (q) in adjacent rooms and functional gaps in the separation elements shall be protected by fire resistant and smoke tight fastenings **EI<sub>2</sub>90-C3S<sub>200</sub>**.

(3) The walls and floors that separate the technical-social annexes, the laboratories and annex workshops from the rooms with very high risks of fire and volumetric explosion, must resist fire depending on the density of the thermal load (q) and volumetric explosion, and the communication gaps strictly functional in the walls are provided with protected buffer rooms, ventilated under pressure and provided with fire-resistant and smoke-tight doors **EI<sub>2</sub>90-C3S<sub>200</sub>** arranged diagonally.

**Article 6.1.3.4.** The closed staircases for the evacuation of users and the lifts are separated from the rest of the construction with fire-resistant walls and floors, according to the regulations.

**Article 6.1.3.5.** In production spaces with medium or low fire risks, offices can be made of non-combustible elements and windows, intended exclusively for the personnel who directly manage the production (foremen, supervisors, management, etc.).

**Article 6.1.3.6.** To limit the spread of fire and smoke in buildings and closed fire compartments, production and/or storage rooms with an area larger than 36 m<sup>2</sup> and a heat load density greater than **105 MJ/m<sup>2</sup>** are provided with smoke exhaust systems and hot gases through natural-organized draft or through mechanical ventilation, according to the provisions of the standard and specific technical regulations. The total useful/aerodynamic area of the free area of devices with automatic smoke discharge aperture in the event of organised natural fire, shall be at least **1 %** from the surface of the floor coverings. When smoke exhaust is provided by mechanical ventilation, the provisions of the Rule and/or technical regulations shall be complied with.

**Article 6.1.3.7.** It is mandatory to ensure the evacuation of smoke and hot gases in case of fire in constructions, compartments and production and/or storage rooms with high or very high fire risks, as well as in closed above-ground production and/or storage constructions, with the area built-up area (Ba) of at least **20,000 m<sup>2</sup>** and width greater than **72 m** or at closed above-ground production and/or storage buildings (rooms) with a built-up area (Ba) greater than **1,000 m<sup>2</sup>**, where the activity is carried out only in light artificial (with full roof and perimeter closing walls, in which only psychological gaps and access doors are provided).

**Article 6.1.3.8. (1)** The evacuation of smoke and hot gases in the event of fire shall be ensured by organised natural draught or mechanical ventilation and shall be carried out in accordance with the regulatory provisions.

(2) The evacuation of smoke and hot gases in case of fire is ensured from each level of the production and/or storage building.

**Article 6.1.3.9. (1)** Closed stairwells, which provide for the evacuation of users and do not have windows to the outside on each level for ventilation and natural lighting, shall be provided with smoke and hot gas exhaust systems in the event of fire, and access buffers thereto (where required) shall have overpressure ventilation.

**(2)** The evacuation of smoke and hot gases in the event of fire from enclosed stairwells and to their buffer rooms (where these are to be provided) shall be by means of an organised natural draught or be pressurised.

**(3)** The evacuation of smoke and hot gases in the event of fire from enclosed underground stairway houses and their buffer rooms (where required) shall only be provided by organised natural draught or are placed in excess pressure.

**Article 6.1.3.10.** The exhaust of smoke and hot gases in the event of fire from rooms and storage spaces shall be independent of other spaces, irrespective of how it is achieved (by natural-organised draught or mechanical ventilation).

**Article 6.1.3.11.** Smoke flues passing through spaces or rooms having other intended uses or fire hazards than those for which they are intended shall have walls so constructed as to comply with the fire resistance requirements of the intended uses and fire hazards concerned, but not less than **EI 60**.

#### **6.1.4. CONSTRUCTIVE ASSEMBLIES**

**Article 6.1.4.1. (1)** Production and/or storage buildings shall be designed so as to meet the performance conditions allowed in the Rules

**(2)** The construction elements used must not spread fire through their composition, arrangement and construction.

**(3)** The interior gaps of the construction elements shall have the continuity interrupted in accordance with the regulations, so as not to favour the easy propagation of smoke and fire in the construction.

**Article 6.1.4.2. (1)** Buildings and enclosed production and/or storage rooms classified as having a medium fire risk, determined by the characteristics of the substances and materials, shall be constructed with walls and floors of reaction to fire class **A1** or **A2-s1d0**.

**(2)** Building elements which separate spaces with a high risk of fire and volumetric explosion from the rest of the construction shall be resistant to fire and explosion.

**Article 6.1.4.3. (1)** Storage rooms with a surface area greater than **36 m<sup>2</sup>** and a heat load density greater than **105 MJ/m<sup>2</sup>** shall be provided with smoke and hot gas exhaust systems and shall be designed, constructed and partitioned off from the rest of the building with fire-resistant elements.

**(2)** Underground storage rooms, regardless of surface area and density of heat load greater than **105 MJ/m<sup>2</sup>** they shall be provided with smoke and hot gas exhaust systems and shall be constructed, carried out and partitioned from the rest of the construction with fire-resistant elements.

**(3)** Storage rooms referred to in paragraphs **1** and **2** they shall be provided with smoke and hot gas exhaust systems by organised natural draught or by mechanical ventilation, in accordance with the rules and specific technical regulations. The total useful/aerodynamic area of the free area of devices with automatic smoke discharge aperture in the event of organised natural fire, shall be at least **1 %** from the surface of the floor coverings. When smoke exhaust is provided by mechanical ventilation, the provisions of the Rule and/or technical regulations shall be complied with.

**Article 6.1.4.4.** Self-supporting or suspended ceilings are not permitted in rooms and enclosed spaces classified as having a very high risk of fire and volumetric explosion.

**Article 6.1.4.5.** The beams, ramps, bridges and steps of internal staircases for functional circulation and escape at work platforms or superstructures without permanent workplaces may be made of materials **R 15** reaction to fire class **A1** or **A2-s1, d0** and not enclosed in stairwells.

**Article 6.1.4.6. (1)** Box-in-box refrigerated warehouses (indoor temperature  $t < 4^{\circ}\text{C}$ ) with an area of less than **100 m<sup>2</sup>** shall not be compartmentalised with fire performance elements and shall not be provided with smoke and hot gas exhaust systems.

**(2)** Box-in-box refrigerated warehouses (indoor temperature  $t < 4^{\circ}\text{C}$ ) with a surface area greater than **100 m<sup>2</sup>** shall be provided with smoke and hot gas exhaust systems in the building/space in which they are located if they are not equipped with automatic oxygen reduction systems.

**(3)** These storage categories shall not be equipped with an internal hydrants extinguishing system.

**Article 6.1.4.7.** Dedicated cold storage buildings (with internal temperature  $t < 4^{\circ}\text{C}$ ) are not provided with smoke and hot gas exhaust systems.

**Article 6.1.4.8. (1)** Deposits **automated** no permanent (working) places of activity shall be equipped with internal hydrants.

**(2)** In **automated** warehouses without permanent places of activity (work) where the storage racks are part of the building's resistance structure, the building structure (columns, beams, trusses, bracing and roof trusses) can be made of metal without performance characteristics regarding fire resistance (unprotected metal structure), with the mandatory provision of an automatic fire extinguishing system with sprinklers or oxygen reduction.

**Article 6.1.4.9.** Storage facilities provided for with an oxygen reduction installation shall not be provided with systems for the evacuation of smoke and hot gases.

## **6.1.5. ESCAPE ROUTES FOR USERS IN CASE OF FIRE**

**Article 6.1.5.1. (1)** The production and/or storage structures shall have evacuation routes for users in the event of fire, arranged, constructed and sized in accordance with the provisions of the legislation.

**(2)** In warehouses without permanent working staff, functional circulations need not meet the conditions laid down for escape routes in the event of fire.

**Article 6.1.5.2.** In manufacturing and/or storage construction, users may also be considered as evacuation routes for users and those passing through:

**a)** rooms or spaces with low fire risks if they serve to evacuate users of neighbouring production areas or their technical-social annexes;

**b)** rooms or spaces of medium, high or very high fire risk, without volumetric explosion, if they serve to evacuate users of adjacent spaces and do not constitute their only escape route, in which case the second escape route may also constitute a space of medium, high or very high fire risk if the routes are distinct and separated from each other by fire resisting walls of at least **EI/REI 60** and the circulation gaps therein are protected by fire resisting and smoke-tight enclosures of at least **EI<sub>2</sub>45-C5S<sub>200</sub>**;

**c)** rooms or spaces with a very high risk of fire and volumetric explosion, if they serve to evacuate users of production or storage spaces with the same risk of fire and do not constitute their only possibility of evacuation;

**Article 6.1.5.3.** The evacuation of the users of the offices located in the production premises and intended for those who directly manage the production (foremen, supervisors, management, etc.) and the reception offices of the warehouses can be ensured through the respective production or storage premises.

**Article 6.1.5.4. (1)** The evacuation stairs of users from above-ground production and/or storage buildings are separated from the rest of the building with minimum fire-resistant walls:

- a) **EI/REI 180** and reaction to fire class **A1** or **A2-s1d0** in buildings with fire stability level **I**;
- b) **EI/REI 120 and** reaction class to fire **A1** or **A2-s1d0** in buildings with fire stability level **II**;
- c) **EI/REI 90 and** reaction class to fire **A1** or **A2-s1d0** in buildings with fire stability level **III**;
- d) **EI/REI 45** and reaction to fire class **A1 A2- s1d0** or **B-s1d0** in buildings with fire stability level **IV**;
- e) **EI/REI 30** and reaction to fire class **A1 A2-s1d0, B-s1d0** or **C-s1d0** in buildings with fire stability level **V**.

**(2)** The separation walls of stairway houses enclosures for the functional movement and evacuation of users from the rest of the construction shall also meet the conditions specific to those fire hazards and/or volumetric explosion in adjacent rooms.

**Article 6.1.5.5. (1)** Floors separating users' stairwells in above-ground production and/or storage buildings from the rest of the building, and their exit routes to the outside at ground level or adjacent carriageway level, shall be fire-resistant in accordance with the requirements for ensuring the level of fire stability of the building, but as a minimum:

- a) **REI 90**, in buildings with fire stability level **I**;
- b) **REI 60**, in buildings with fire stability level **II**;
- c) **REI 45** in buildings with fire stability level **III**;
- d) **REI 30** in buildings with fire stability level **IV**;
- e) **REI 15** in buildings with fire stability level **V**.

**2.** In above-ground production and/or storage buildings, open internal stairways may be provided for the evacuation of users in the following cases:

- a) buildings with fire stability level **I, II** or **III** and low fire risks, if they serve the evacuation of users of not more than 2 levels and the number of users is less than **50**;
- b) constructions with fire stability level **I** or **II** and medium fire risks, if they serve to evacuate a single level and a maximum number of users **30**;

**(3)** Regardless of the level of fire stability and fire risk, in production and/or storage buildings, open stairs can be provided for user access to machines, equipment, walkways, open platforms, lifts, etc., which do not constitute permanent workplaces.

**Article 6.1.5.6. (1)** Gaps through which users of production and/or storage buildings have access to enclosed escape ladders shall be protected by:

- a) fire and smoke-tight doors **E 30-C5S<sub>200</sub>**, when they constitute an access way from rooms with a low fire risk;
- b) fire-resistant and smoke-tight doors **EI<sub>2</sub> 45-C5S<sub>200</sub>**, when they constitute an access path from rooms with medium fire risk;
- c) fire-resistant and smoke-tight doors **EI<sub>2</sub> 90-C5S<sub>200</sub>** or protected buffer rooms, ventilated under pressure, provided with fire-resistant and smoke-tight doors **EI<sub>2</sub> 45-C5 S<sub>200</sub>** on the above-ground levels of the building and respectively **EI<sub>2</sub> 90-C5 S<sub>200</sub>** on the levels underground, when it is an access route from rooms with a high risk of fire;

d) protected, overpressure-ventilated buffer rooms fitted with fire-resistant and smoke-tight doors **EI<sub>2</sub> 90-C5S<sub>200</sub>** where they constitute access routes from rooms with a very high fire risk.

(2) When there are rooms of different risks with access to the evacuation ladder through a corridor, the door of the corridor to the ladder shall correspond to the highest fire risk.

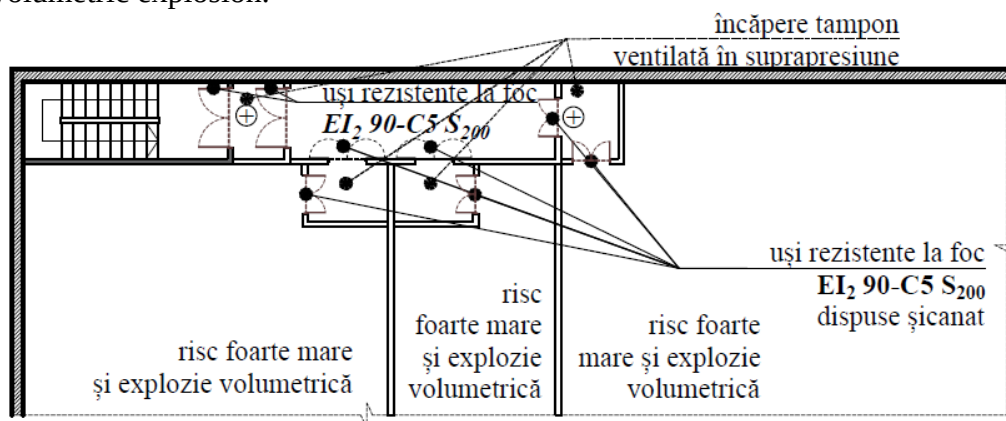
**Article 6.1.5.7. (1)** In production and/or storage construction, separation walls from the rest of the construction of common horizontal operating and exhaust circulations shall be at least fire-resistant:

- a) **EI/REI 90 and** reaction class to fire **A1** or **A2-s1d0** in buildings with fire stability level **I**;
- b) **EI/REI 60 and** reaction class to fire **A1** or **A2-s1d0** in buildings with fire stability level **II**;
- c) **EI/REI 45 and** reaction class to fire **A1** or **A2-s1d0** in buildings with fire stability level **III**;
- d) **EI/REI 30 and** reaction class to fire **A1 A2- s1d0** or **B-s1d0** in buildings with fire stability level **IV**;
- e) **EI/REI 15** and reaction to fire class **A1 A2-s1d0, B-s1d0, B-s2d0, C-s1d0** or **C-s2d0** in buildings with fire stability level **V**.

(2) In production and storage structures, the functional horizontal common circulation separation walls and the evacuation of users from the rest of the construction shall also meet the conditions specific to those risks of fire and/or volumetric explosion in adjacent rooms.

**Article 6.1.5.8.** The circulation gaps arranged in the walls separating the common horizontal circulations in the production and/or storage buildings are protected according to the specific fire risks of the adjacent rooms, respectively with watertight or fire-resistant and smoke-tight doors that ensure at least:

- a) **E 15-C5S<sub>200</sub>** at low fire risk;
- b) **EI<sub>2</sub> 45-C5S<sub>200</sub>** at medium fire risk;
- c) **EI<sub>2</sub> 60-C5S<sub>200</sub>** at high fire risk;
- d) **EI<sub>2</sub> 90-C5S<sub>200</sub>** at very high risk of fire, i.e. protected buffer rooms, ventilated in overpressure and equipped with fire-resistant **EI<sub>2</sub> 90-C5 S<sub>200</sub>** doors (Figure 76), in those that are also at risk of volumetric explosion.



PRODUCȚIE ȘI/SAU DEPOZITARE

încăpere tampon ventilată în suprapresiune	ventilated buffer room under overpressure
risc foarte mare și explozie volumetrică	very high risk and volumetric explosion
uși rezistente la foc <b>EI<sub>2</sub> 90-C5 S<sub>200</sub></b> dispuse șicanat	fire-resistant doors <b>EI<sub>2</sub> 90-C5 S<sub>200</sub></b> arranged baffled
PRODUCȚIE ȘI/SAU DEPOZITARE	PRODUCTION AND/OR STORAGE

**Figure 76 - Protected, overpressure-ventilated buffer rooms with fire doors of at least EI<sub>2</sub> 90-C5S<sub>200</sub> arranged in a baffled arrangement (at risk of volumetric explosion)**

**Article 6.1.5.9.** The landing gaps through which users have access to passenger lifts, freight lifts or other mechanical means of vertical transport in production and/or storage buildings shall be protected with:

- a) **EI 30** fire resistant doors, when they constitute access from rooms with a low fire risk;
- b) **EI 45** fire resistant doors, when they constitute access from rooms with a medium fire risk;
- c) **EI 90** fire resistant doors, or protected, pressure-ventilated buffer rooms fitted with fire and smoke-tight doors **EI 45-C5S<sub>200</sub>** on the upper storeys of the building and protected, pressure-ventilated buffer rooms fitted with fire and smoke-tight doors **EI 90-C5S<sub>200</sub>** on the lower storeys, respectively, where they provide access from high fire risk rooms;
- d) protected, overpressure-ventilated buffer rooms fitted with fire-resistant and smoke-tight doors **EI 90-C5S<sub>200</sub>** where they constitute access routes from rooms of very high fire risk.

**Article 6.1.5.10.** Decks, ramps and beams of internal escape staircases shall comply with the fire performance requirements laid down in **Art.2.4.2.5.** and **Art.2.4.2.6.**

**Article 6.1.5.11.** Decks, handrails and open stair beams, whether interior or exterior, must be non-combustible.

**Article 6.1.5.12. (1)** In production and/or storage buildings, the stairways on underground levels shall be separated from the stairways above ground by minimum EI/REI 120 fire resisting walls, providing access to the underground stairways directly from the outside.

**(2)** Functional communication between the stair landings of the underground levels and the stair landings above ground may be provided at ground floor level or at the intermediate landing between the basement and the ground floor by a protected gap with a fire-resistant and smoke-tight door **EI<sub>2</sub> 90-C5S<sub>200</sub>**.

**(3)** Exceptions are strictly functional access routes to technical basements and cases where the basement is not separated from the above-ground construction by a fire-resistant and smoke-tight door (corridors meet the requirements for stairwells).

**Article 6.1.5.13. (1)** For the evacuation of users of permanent workplaces of open above-ground production and/or storage platforms, including work rooms arranged thereon, escape stairs shall be provided regardless of the number of levels and fire hazards.

**(2)** Open external escape staircases shall be located, constructed and protected in such a way that the movement of users cannot be blocked by flames or smoke produced in the event of a fire in the building for which they are intended or the buildings in the vicinity, in accordance with the general provisions.

**Article 6.1.5.14. (1)** In determining the escape passage units (flows) to be provided in the event of fire in production buildings, the total number of permanent users in the most numerous shift, as determined by design, shall be taken into account.

**(2)** For storage buildings, users with permanent activity, established by the project, are taken into account. When there are no permanent users in the warehouse, the evacuation conditions are not mandatory.

**Article 6.1.5.15.** The standardized number of users per unit of passage (flow) of evacuation ( $U_f$ ) from production and/or storage buildings are specified in Table 115.

**Table115: The standard number of users per unit of passage (flow) of evacuation ( $U_f$ ) from production and/or storage buildings**

<b>Item No</b>	<b>Destination of the building or part of the building from which the users are evacuated</b>	<b>Expected number of users per exhaust passage (flow) unit (Uf)</b>
1	For production and/or storage with low fire risk.	90
2	For production and/or storage with a medium fire risk.	75
3	For production and/or storage with high or very high fire risk.	65

**Article 6.1.5.16.** The lengths of the evacuation routes for users from the production and/or storage buildings are ensured according to the provisions of **Art. 2.5.14.1.** and Table 116 of these Rules.

**Table 116: Disposal lengths in production and/or storage buildings**

<b>Production and/or storage buildings</b>		<b>Maximum exhaust length</b>		
<b>Fire risks</b>	<b>Fire stability level provided</b>	<b>In two different directions at:</b>		<b>In one direction (flooded corridor) at:</b>
		<b>ground floor</b>	<b>floors or basements</b>	<b>ground floor, floors, basements</b>
		<b>metres</b>	<b>metres</b>	<b>metres</b>
<b>Small</b>	<b>I - II</b>	<b>Not regulated</b>		
	<b>III</b>	<b>Not regulated</b>		
	<b>IV</b>	100	75	25
	<b>V</b>	60	50	25
<b>Medium</b>	<b>I - II</b>	<b>Not regulated</b>		
	<b>III</b>	100	75	25
	<b>IV</b>	60	50	25
	<b>V</b>	50	40	25
<b>Tall</b>	<b>I - II</b>	100	75	25
	<b>III</b>	80	60	25
	<b>IV</b>	50	30	25
	<b>V</b>	45	25	25
<b>Extra High</b>	<b>I - II</b>	100	75	25
<b>Very large and volumetric explosion</b>	<b>I - II</b>	30	25	20

Notes:

- a) The length of the escape route is not to be regulated in all situations where a maximum of 10 users may be present simultaneously at each level of the production and/or storage building, irrespective of the fire risk and the fire stability level of the building.
- b) In production and/or storage structures, circulations passing through rooms or spaces with a fire risk of less than or equal to that from which users are evacuated may be considered as escape routes, except as specified in **Article 6.1.5.2.**
- c) The evacuation of users of the spaces/rooms located in the same fire compartment (production and/or storage) may be provided through the spaces on which they serve regardless of their risks (evacuation of technical and social annexes, offices, holding workshops, etc. may be evacuated through production/storage facilities they serve);

**d)** In rooms and spaces without permanent places of work, the requirements relating to escape routes in the event of fire shall not be required.

**Article 6.1.5.17.** The escape routes of users of the production and/or storage buildings shall be marked with orientation indicators as required **SR EN ISO 7010**.

**Article 6.1.5.18. (1)** Agro-zootechnical buildings are assimilated to production buildings. For the evacuation of animals from agro-zootechnical buildings, at least two exits must be provided, judiciously distributed. In buildings or premises with a housing capacity of up to 10 large cattle or 6 horses, only one exit is allowed for the evacuation of animals.

**(2)** The number of animals allowed to escape per door is given in Table 117, depending on the category of animal and the fire stability level of the building.

**Table 117: Maximum number of animals allowed per outlet**

Destination of the building	Fire stability level of the building		
	I and II	III and IV	V
Cow stables	35	35	25
Stables for young bulls	50	50	30
Stables for working animals	35	35	25
Stables for elite horses	25	25	-
Stables (housing) for sows with piglets and for boars	35	35	25
Stables for young pigs and fattening pigs	200	200	150
Closed compartments of the valves	200	200	150
Shelters for fattening sheep	150	100	100

Notes:

- a)** The number of piglets and lambs is not taken into account in the stables (shelters) of sows (maternities) and in the closed barns;
- b)** In the stables (shelters) of pigs and bulls, buildings of level I-II fire stability, which do not contain combustible construction elements and in which combustible bedding is not used, the number of escape doors will be established by the designer depending on the technological process, also taking into account the possibilities of ensuring a quick evacuation in case of fire;
- c)** The number and width of exits for the evacuation of birds (including small animals such as nutria) are not regulated, they are established in relation to the specific technological requirements;
- d)** For other species, the maximum number of animals allowed per evacuation door shall be determined by assimilation to those mentioned in the table.

**(3)** When determining the number of exhaust exits, those which lead directly to the outside shall be regarded as exits.

**(4)** Exits shall be distributed as evenly as possible over the outer contour of the building, taking into account the number and placing of the animals in the enclosure. The designer must obligatorily include the plan with the escape routes, by group of animals. The maximum length of the escape route for tethered animals, up to the exit from the building, must not exceed **30 m**. In the case of free stables (untethered animals), this distance can be increased up to **50 m**. Except for level **I-II** buildings fire stability (under the conditions established in point **b)** of the Notes to Table 117), where it is accepted that the length of the escape route should be no more than **45 m** and respectively **60 m** to the exit from the building.

**(5)** The opening of the exit doors and gates, as well as the doors of the boxes that open into the alleys, must be done in the direction of evacuation. It is not allowed to build thresholds in front of doors or gates for the evacuation of animals. A ramp with a maximum slope of 1/10 is allowed.

**(6)** The width of the evacuation passages inside the stables/shelters will be established depending on the species and the number of animals that evacuate on each route provided in the evacuation plan, so that their dimensions correspond to the width of the doors that serve them.



(7) The minimum width of escape doors shall be determined on the basis of the animal species and the number of animals to be discharged without being less than:

- 2 m for the doors of the stables of bulls and horses;
- 1,50 m for the doors of the calf stables up to 6 months;
- 0,90 m for the doors of pig sheds (shelters);
- 1,25 m for the closed compartments of the saivans;
- 2,50 m for the gates of the sheep pens.

Exceptions are buildings of level **I-II** fire stability (under the conditions set out in point **b**) of the Notes to Table 117 whose escape doors (widths) are technologically dimensioned.

(8) In order to ensure rapid evacuation of large animals, a system of simultaneous unbinding in groups will be adopted. Exceptions are buildings of fire stability levels I-II under the conditions laid down in paragraph b) of the Notes to Table 117.

(9) The exit doors shall as a general rule be of the normal hinged or pivoted type, sliding or tilting doors on a horizontal axis being permitted, with openings to the outside only where their clear width exceeds 2 m, and shall be provided with systems permitting easy operation from inside and outside.

(10) Bulk grain (cereal) stores not intended for bulk animal feed shall be treated in accordance with the specific provisions for storage functions.

### **6.1.6. FIRE ACCESS, INTERVENTION AND RESCUE CONDITIONS**

**Article 6.1.6.1.** Production and/or storage structures shall have access, intervention and rescue routes in the event of fire so arranged and constructed that the intervention forces can operate as quickly and safely as possible.

**Article 6.1.6.2.** Production and/or storage buildings must allow the access of emergency vehicles on at least two sides, except for those with a developed area (Da) of less than 2,000 m<sup>2</sup> where it can be provided on one side.

**Article 6.1.6.3. (1)** The external traffic routes for the emergency vehicles in case of fire must allow the intervention especially to the more dangerous areas of the construction, to the gaps (protected or unprotected) in the external walls and to the water supply sources.

(2) Internal traffic routes and for intervention in case of fire, will be composed, equipped and marked accordingly, so that they are easily recognizable by the personnel who intervene in case of fire.

### **6.1.7. EQUIPPING BUILDINGS WITH FIRE-FIGHTING INSTALLATIONS AND APPLIANCES**

**Article 6.1.7.1. (1)** Buildings, compartments and premises with a production and/or storage function with an area larger than 600 m<sup>2</sup> and thermal load density greater than 105 MJ/m<sup>2</sup> it shall be fitted with internal hydrant extinguishing systems, with the exception of bulk cereal stores.

(2) Equipping buildings with a production and/or storage function with a thermal load density greater than 105 MJ/m<sup>2</sup> and the volume greater than 3,000 m<sup>3</sup> is equipped with an extinguishing system with external hydrants.

(3) The dimensioning of extinguishing installations with internal hydrants and external hydrants is done according to the provisions of the specific technical regulations.

(4) Buildings, compartments and premises with a production and/or storage function with an area larger than 600 m<sup>2</sup> and thermal load density greater than 105 MJ/m<sup>2</sup> it shall be equipped with fire detection, signalling and alarm facilities, in accordance with the provisions of the specialised technical regulations, with the exception of bulk cereal stores.

(5) The production and/or storage structures shall be fitted with portable extinguishers, with provision being made for a portable extinguisher with extinguishing performance **21A and 113B** to

the maximum **150 m<sup>2</sup>** area deployed at premises with very high risk (and/or volumetric explosion hazard) or high and maximum risk respectively **200 m<sup>2</sup>** in spaces of medium or low risk, but at least two extinguishers on each level of the building.

**6.** In rooms and spaces with an area larger than **500 m<sup>2</sup>** and in which combustible liquids may be present, portable fire extinguishers with extinguishing performance for type **A** and **B** fires are also provided, recommending a fire extinguisher of at least **50 kg** for every **500 m<sup>2</sup>**.

**(7)** The equipment with automatic fire extinguishing systems with sprinklers is provided according to Standard **P118:2** and/or **SR EN 12845**.

## SECTION II

### 6.2. Performance specific to production and storage construction

#### 6.2.1. Typical production and storage buildings

**Article 6.2.1.1. (1)** Ordinary production and storage buildings are those that are not above-ground closed production and/or storage buildings, with a built-up area (**B<sub>a</sub>**) of at least **20,000 m<sup>2</sup>** and a width greater than **72 m** or production buildings (rooms) and/or closed above-ground storage with a built-up area (**B<sub>a</sub>**) greater than **1,000 m<sup>2</sup>** and in which the activity is carried out only with artificial light (with roof and full perimeter closing walls, in which only psychological gaps and access doors are provided)

**(2)** Buildings, fire compartments, spaces and production or storage rooms will have fire risks specified.

**(3)** Fire structures and fire compartments shall have the fire stability levels provided.

**Article 6.2.1.2.** Conventional production and storage buildings can have any level of fire stability, if they are conformed in such a way that the standardized correlation conditions between the level of fire stability ensured (according to the minimum conditions that the construction must meet in order to be included in the fire stability level specified in Art. 2.1.3.2. and in Table 3), the fire risk, the number of levels and the area of the fire compartment, according to the provisions of Art. 6.1.2.2. and Table 114.

**Article 6.2.1.3.** Combustible materials and substances may be stored in production rooms only in the minimum quantities required for the technological flow for an exchange, specified by the beneficiary. The storage of combustible materials and substances in larger quantities than those permitted in production rooms shall be carried out in their own premises, located, constituted, separated and protected in accordance with the provisions of the specific technical regulations and regulations.

**Article 6.2.1.4. (1)** Ordinary production and storage structures may be located independently or merged with other production and/or storage constructions, within the boundaries of the areas of fire compartments permitted by the regulations.

**(2)** Production and storage buildings shall not be combined with civil buildings, but must be subdivided with fire-resistant walls according to the thermal load density (**q**) of the adjacent rooms, in accordance with the provisions of **Art. 2.3.1.2** and **Table 5** and, where appropriate, with volumetric blast-resistant walls, in accordance with the provisions of **Chapter 2.3.4**. Buildings with production and/or storage functions may be combined (with each other), ensuring the appropriate partitioning and protection measures for each function.

**(3)** Buildings shall be placed in relation to other neighbouring buildings at the safety distances specified in **Art. 2.2.1.2** and Table 4 or shall be partitioned by fire-resistant walls according to the thermal load density (**q**) as specified in **Art. 2.3.1.2** and **Table 5** and, where appropriate, also volumetric blast-resistant walls, constructed in accordance with the applicable provisions.

**Article 6.2.1.5.** By conforming the production and storage buildings, the spaces with high and very high fire risks are arranged in distinct areas, ensuring the appropriate fire protection measures, so that, in the event of a fire, large built-up areas are not affected and do not endanger neighbouring buildings or be endangered by fires in the vicinity.

**Article 6.2.1.6.** Construction and storage rooms for combustible materials and substances shall be carried out in accordance with the provisions of the legislation, taking into account the fire risk, the hazard class of stored materials and substances, the contribution they can bring to the initiation and development of fires and their sensitivity to the effects of fires, in accordance with the *Annex*.

**Article 6.2.1.7. 1.** Between functionally independent but joined portions of buildings within a fire compartment, for the separation of medium, large and very large hazards without volumetric explosion risk, partitions shall be provided with fire resistance determined according to the highest thermal load density ( $q$ ) of the adjacent spaces, but not less than **EI/REI 120** for walls and **REI 90** for floors. The communication gaps in these walls shall have a minimum fire and smoke performance of **EI<sub>2</sub>60-C3S<sub>200</sub>** for medium risk and **EI<sub>2</sub>90-C3S<sub>200</sub>** for high and very high risk without volumetric explosion risk.

**(2)** When separating rooms or spaces with very high fire and volumetric explosion risks, the partitions shall also be explosion resistant.

**Article 6.2.1.8.** In normal production and storage structures, appropriate numbers of users shall be supplied, distributed, constructed, constructed and sized in accordance with the provisions of the legislation.

**Article 6.2.1.9.** For fire intervention, normal production and/or storage buildings shall have access and circulation facilities for fire-fighting vehicles on at least one side, so as to ensure access and intervention by fire-fighting vehicles on at least **25%** of the perimeter of the external walls.

## **6.2.2. Production and storage buildings of a special type**

**Article 6.2.2.1.** Closed above-ground constructions for production and/or storage, with a built-up area (**Ba**) of at least **20,000 m<sup>2</sup>** and a width of more than **72 m** must meet the conditions of inclusion in levels **I** or **II** of fire stability (according to the minimum conditions that their construction must meet the fire stability level **I** or **II** specified in **Art. 2.1.3.2** and in Table 3) and they comply in such a way as to meet the correlation conditions established in **Art. 6.1.2.2.** and Table 114.

**Article 6.2.2.2.** Closed above-ground buildings and rooms with a built-up area (**Ba**) greater than **1,000 m<sup>2</sup>** in which the activity is carried out only with artificial light (with a full roof and perimeter closing walls, in which only psychological gaps and access doors are provided) are made up and carried out in accordance with the provisions of the standard (in accordance with the minimum conditions that the construction must meet in order to be included in the fire stability level specified in **Art. 2.1.3.2.** and in Table 3), complying in such a way as to meet the established correlation conditions in **Art. 6.1.2.2.** and Table 114.

**Article 6.2.2.3. (1)** Closed above-ground production and/or storage buildings with a built-up area (**Ba**) of at least **20,000 m<sup>2</sup>** and a width greater than **72 m** are located independently of other neighbouring buildings, at least at the safety distances stipulated in **Art. 2.2.1.2.** and Table 4, increased by **100%**, with the exception of the constructions that serve them, i.e. transformer station, generators, water tanks (except for the pumping station), etc., which are located at the safety distances according to their specific provisions.

(2) It is forbidden to combine closed above-ground production and/or storage constructions with a built-up area (**Ba**) of at least **20,000 m<sup>2</sup>** and a width greater than **72 m** with other production/storage or civil constructions.

**Article 6.2.2.4. (1)** Closed above-ground production and/or storage buildings with a built-up area (**Ba**) greater than **1,000 m<sup>2</sup>** and in which the activity takes place only with artificial light can be located independently or combined with other production and/or storage buildings.

(2) Self-contained enclosed above-ground production and/or storage buildings with a floor area (**Ba**) greater than **1,000 m<sup>2</sup>** and in which the activity is carried out in artificial light only shall be located at the safety distances from other neighbouring buildings as specified in **Art. 2.2.1.2.** and Table 4, or shall be partitioned with fire-resistant fire compartment separating walls.

(3) The adjoining of other production and/or storage buildings may be carried out within the limits of the fire compartments laid down in **Art. 6.1.2.2** and Table 114, ensuring the separation of the different functions with vertical and horizontal building elements with fire resistances determined according to the heat load density (**q**) of the adjacent spaces, but not less than **REI 180** or **EI 180-M** for walls and **REI 120** for floors.

**Article 6.2.2.5.** Construction portions or groups of rooms with a high or very high risk of fire are recommended to be arranged adjacent to the perimeter closures of the construction and grouped as much as possible, in closed above-ground production and/or storage buildings with a built-up area (**Ba**) of at least **20,000 m<sup>2</sup>** and the width greater than **72 m**.

**Article 6.2.2.6.** Closed above-ground production and/or storage rooms with a built-up area (**Ba**) greater than **1,000 m<sup>2</sup>** and in which the activity is carried out only with artificial light with high or very high fire risks will be arranged, as far as possible, in distinct areas of the construction.

**Article 6.2.2.7. 1.** In closed above-ground production and/or storage buildings with a built-up area (**Ba**) of at least **20,000 m<sup>2</sup>** and a width greater than **72 m**, rooms and fire compartments with an area greater than **36 m<sup>2</sup>** and a thermal load density greater than **105 MJ/m<sup>2</sup>** are provided with smoke and hot gas exhaust systems through natural-organized draft or mechanical ventilation, according to the provisions of the standard and specific technical regulations. The total useful/aerodynamic area of the free area of devices with automatic smoke discharge aperture in the event of organised natural fire, shall be at least **1 %** from the surface of the floor coverings. When smoke exhaust is provided by mechanical ventilation, the provisions of the Rule and/or technical regulations shall be complied with.

(2) Smoke exhaust devices through natural-organized draft, will have a total useful/free aerodynamic area of at least **1%** of the floor area of the room where smoke and hot gas exhaust systems are provided.

**Article 6.2.2.8. (1)** In buildings, fire compartments and closed above-ground production and/or storage rooms with a built-up area (**Ba**) greater than **1,000 m<sup>2</sup>** and in which the activity takes place only with artificial light, rooms and fire compartments with an area greater than **36 m<sup>2</sup>** and thermal load density greater than **105 MJ/m<sup>2</sup>**, is provided with smoke and hot gas exhaust systems through natural-organized draft or mechanical ventilation, according to the provisions of the standard and specific technical regulations. The total useful/aerodynamic area of the free area of devices with automatic smoke discharge aperture in the event of organised natural fire, shall be at least **1 %** from the surface of the floor coverings. When smoke exhaust is provided by mechanical ventilation, the provisions of the Rule and/or technical regulations shall be complied with.

(2) Smoke exhaust devices through natural-organized draft, will have a total useful/free aerodynamic area of at least **1%** of the floor area of the room where smoke and hot gas exhaust systems are provided.

**Article 6.2.2.9.** Closed above-ground production and/or storage buildings with a built-up area (Ba) of at least **20,000 m<sup>2</sup>** and a width of more than **72 m** and closed above-ground production and/or storage buildings and rooms with a built-up area (Ba) of more than **1,000 m<sup>2</sup>** in which the activity is carried out only with artificial light, there will be an adequate number of escape routes for users, dimensioned, distributed, made up and made according to the regulations.

**Article 6.2.2.10. (1)** Inside enclosed above-ground production and/or storage buildings with a built-up area (Ba) of at least **20,000 m<sup>2</sup>** and a width of more than **72 m**, fire hydrants shall also be provided, located at floor level or buried in the floor, in special, suitable boxes so located that they can be used for extinguishing purposes.

**(2)** In closed above-ground production and/or storage buildings with a built-up area (Ba) of at least **20,000 m<sup>2</sup>** and a width greater than **72 m**, where the protection of the entire surface from external fire hydrants cannot be ensured, fire hydrants are provided inside the tunnels or special protected evacuation openings.

**Article 6.2.2.11. (1)** For intervention from the outside in case of fire, closed above-ground production and/or storage buildings with a built-up area (Ba) of more than **1,000 m<sup>2</sup>** in which the activity is carried out only with artificial light will have access and circulation routes for emergency vehicles, at least on two sides, so as to ensure the access and intervention of firefighting vehicles in case of fire, at least on **50%** of the perimeter of the external walls.

**(2)** The access of construction intervention personnel is ensured through the functional circulations of the construction and through access panels provided in the full perimeter closing walls (external), panels arranged at a maximum of **60 m** from each other, easily removable from the outside and visibly marked to be easily recognizable in case of fire.

**Article 6.2.2.12.** Closed above-ground production and/or storage buildings with a built-up area (Ba) of at least **20,000 m<sup>2</sup>** and a width greater than **72 m** will have access roads, possibilities for the intervention of special vehicles, at least on two sides, so that they ensure the access and intervention of firefighting vehicles in case of fire, at least on **50%** of the perimeter of the external walls.

## SECTION III

### 6.3. Performances specific to buildings for storing materials and substances

#### 6.3.1. Common provisions

**Article 6.3.1.1. (1)** Closed storage buildings and open storage buildings for materials and substances shall have fire risks established and specified in accordance with the provisions of **Article 2.1.2.2** and **Article 2.1.2.5**.

**(2)** When making deposits related to civil buildings, the provisions regarding the specific performances of these constructions are also respected.

**Article 6.3.1.2. (1)** Closed warehouses of materials and substances can be located independently or combined with other constructions.

**(2)** Open warehouses of materials or substances are located only independently of their neighbours, at the minimum distances stipulated in this regulation, being considered fire stability level V constructions (open warehouses of solid combustible materials, warehouses of combustible liquids category **D6**, class **L III** and category **D7** are located in relation to the neighbourhoods at the minimum distances stipulated by the regulations).

(3) **D6** category, **L III** class combustible liquid warehouses (storages consisting of above-ground tanks) are located at least **30 m** away from buildings, and category **D7** warehouses **20 m** away from buildings.

(4) Closed constructions for the storage of materials or substances are located in front of neighbouring objects at least at the safety distances established in Art. 2.2.1.2. and Table 4, as well as in the specific technical regulations or are compartmentalized according to the regulations. For closed stores with very high fire risks the regulatory safety distances shall be increased by **100 %**.

(5) Open deposits for combustible materials shall be located from neighbours at a minimum distance of **10 m** unless the specific regulations provide otherwise.

(6) When placing warehouses, consideration is given to limiting the possibilities that a fire in the warehouse could endanger neighbouring constructions or installations, or that the warehouse could catch fire due to a fire at a neighbouring construction or installation.

(7) Combustible liquid storages are located in areas located lower than the neighbouring constructions so that it is not possible to spill or leak liquids and spread the fire in the vicinity, or appropriate protection measures are provided (dykes, protective walls, etc.). The location of these warehouses will also ensure distances and protective measures from watercourses, lakes, ponds, swamps, etc., located in the vicinity.

**Article 6.3.1.3.** Closed storage structures merged with each other or with other constructions shall be subdivided in accordance with the provisions of the legislation.

**Article 6.3.1.4. (1)** The storage of materials and substances shall be carried out according to their physical-chemical characteristics so that they do not start fires and, if fires do occur, they can be extinguished with suitable extinguishing agents.

(2) Different materials and substances may be stored in the same room if their mixture or vapour does not present a risk of self-ignition or volumetric explosion and, in the event of fire, the same extinguishing products may be used.

(3) Storage of solid materials with liquids or combustible gases is not permitted. Exceptions are those specified in the specific technical regulations.

(4) When storing materials or substances that present a risk of self-entrapment, it is mandatory to determine the duration of their storage and to take the necessary measures to check their temperature.

(5) Ammonium nitrate stores shall only be made of building materials without gaps, reaction to fire class **A1** and shall be located at the minimum distances from other buildings.

**Article 6.3.1.5. (1)** Storage facilities or storage rooms for materials or substances shall not be permitted to pass (through) pipelines for combustible gases or liquids, heating or water, as well as electricity networks, associated with other consumers (outside these premises).

(2) By exception and on the basis of technical justification, these crossings will be made in their own channels, closed with fire-resistant construction elements minimum **EI/REI 180**.

(3) It is forbidden to lay pipes for water or for products containing water or on which water can condense in storage places for materials or substances which react dangerously with water.

**Article 6.3.1.6. (1)** Storage facilities for materials or substances shall have access, functional and evacuation routes in the event of fire, sized and constructed in such a way as to ensure the evacuation of users and to permit fire-fighting.

(2) In storage buildings without permanent workplaces (which can be visited no more than 8 times per shift), it is not mandatory to comply with the specific conditions for escape routes for users in case of fire.

**Article 6.3.1.7. 1.** In constructions for the storage of materials or substances, combustible liquids may be stored in tanks or containers (packaging) in the cases and under the conditions laid

down in specific regulations and technical regulations, taking into account also the provisions of **Annexes** on ‘*Combustible liquid fuel classes*’ and ‘*Categories of combustible liquid deposits*’.

**(2)** Regardless of how combustible liquids are stored, it is mandatory to specify the category of storage, the zoning of fire and, where appropriate, volumetric explosion hazards and the provision of the specific protection measures laid down in the regulations and in the specific technical regulations, so as to ensure that the spread of fire is limited and the conditions for extinguishing fires are met in an effective manner.

**(3)** Where storage buildings are of a special type, i.e. enclosed above-ground buildings with a floor area (Ba) of at least 20,000 m<sup>2</sup> and a width of more than 72 m or enclosed above-ground buildings with a floor area (Ba) of more than 1,000 m<sup>2</sup> and where the activity is carried out under artificial light only, their specific fire safety measures shall also be observed.

**Article 6.3.1.8.** Storage rooms with an area greater than 36 m<sup>2</sup> and a heat load density greater than 105 MJ/m<sup>2</sup> shall be provided with exhaust systems for smoke and hot gases by natural-organised draught or by mechanical ventilation, according to the provisions of the standard and specific technical regulations. The total useful/aerodynamic area of the free area of devices with automatic smoke discharge aperture in the event of organised natural fire, shall be at least **1 %** from the surface of the floor coverings. When smoke exhaust is provided by mechanical ventilation, the provisions of the Rule and/or technical regulations shall be complied with.

### **6.3.2. Closed deposits of combustible materials and substances**

**Article 6.3.2.1. (1)** Enclosed buildings for the storage of combustible materials and substances (enclosed warehouses), shall have the level of fire stability assured according to the fire risk and the hazard class of the products stored, and shall be so designed as to meet the conditions of correlation allowed between the level of fire stability assured, the number of levels and the constructed area (Ba), according to the provisions of Art. 6.1.2.2. and Table 114.

**2.** If the enclosed warehouse building is an enclosed above-ground building with a floor area (**Ba**) of at least **20,000 m<sup>2</sup>** and a width of more than **72 m** or an enclosed above-ground building with a floor area (**Ba**) of more than **1,000 m<sup>2</sup>** and where the activity is carried out under artificial light only, it is also mandatory to comply with the performance provisions specific to these particular types of buildings.

**Article 6.3.2.2. (1)** Enclosed multi-storey storage buildings shall have floors with fire resistance REI corresponding to the thermal load density (q) in accordance with **Table 5** in conjunction with Table 3 (whichever is the higher) so constructed as to prevent the propagation of fire between levels of the building.

**(2)** An exception to **paragraph. (1)** storage buildings with mechanised storage platforms and without permanent working places, where the platforms (in whole or in part) may be made of non-combustible materials and elements where automatic fire-extinguishing installations are provided at all levels.

**Article 6.3.2.3. (1)** Enclosed structures for the storage of combustible liquids shall be made of fire-resistant materials and construction elements in accordance with the provisions of the standard and specific technical regulations, ensuring the subdivision of storage rooms with a maximum capacity of 50 m<sup>3</sup> of liquids of classes L I or L II (respectively equivalent for liquids of class L III), with fire-resistant walls EI/REI and, where appropriate, resistant to volumetric explosion.

**(2)** Buildings for the storage of combustible liquids shall have specified fire and volumetric explosion hazard zoning.

**Article 6.3.2.4.** Enclosed stores for combustible materials and substances shall be so arranged as not to facilitate the spread of fire over large areas, and spaces with very high fire risks shall, as far as possible, be arranged in separate areas.

**Article 6.3.2.5. (1)** Enclosed buildings and rooms for the storage of combustible materials and substances shall be provided with systems for the evacuation of smoke and hot gases in the event of fire by means of natural-organised draught or mechanical ventilation and, where appropriate, with pressure relief panels for those with a volumetric explosion hazard, in accordance with the provisions of the standard and specific technical regulations.

**(2)** Smoke exhaust devices through natural-organized draft, will have a total useful/free aerodynamic area of at least 1% of the floor area of the room where smoke and hot gas exhaust systems are provided.

**(3)** The decompression panels of stockpiles of very high risk of fire and volumetric explosion shall have the area necessary to ensure the standardised ratio in accordance with **Article 2.3.4.1.4.** and **Article 2.3.4.1.5.**

**Article 6.3.2.6. (1)** Enclosed stores for combustible materials and substances shall have appropriate numbers of routes for the disposal of users, sized, distributed, constructed and carried out in accordance with the provisions of the legislation.

**(2)** In closed warehouses with no permanent workplaces (which can be visited a maximum of 8 times per shift), it is not mandatory to comply with the specific conditions for escape routes in case of fire.

**Article 6.3.2.7.** For external intervention in the event of fire, closed storage buildings for combustible materials and substances with a built-up area (Ba) greater than 1,000 m<sup>2</sup> shall have access and intervention routes for fire-fighting vehicles on at least two sides so as to ensure access and intervention of fire-fighting vehicles in the event of fire on at least 50% of the perimeter of the external walls, and enclosed spaces with a smaller built-up area may have access on one side only so as to ensure that fire-fighting appliances have access to at least 25% of the perimeter of the external walls for fire-fighting purposes.

## **SECTION IV**

### **6.4. PERFORMANCE SPECIFIC TO OPEN ABOVE-GROUND STORAGE OF COMBUSTIBLE MATERIALS AND SUBSTANCES**

**Article 6.4.1.** The location of open stores of solid, liquid or gaseous combustible materials and substances shall be carried out in accordance with the provisions of the specific technical regulations and regulations, ensuring that the slight spread of fire is limited and the appropriate conditions for intervention in the event of fire. Open deposits of combustible solid materials shall be located from neighbourhoods at minimum distances of **10 m**.

**Article 6.4.2.** Category **D6**, Class **L III** (above ground tanks) combustible liquid stores shall be located at least 30 m away from buildings and Category **D7** at least **20 m** away from buildings. Where tanks are buried, distances may be reduced by 50%.

**Article 6.4.3.** In the case of storage of combustible materials and materials from different sorts on the same outside platform, the products shall be arranged in such a way as not to encourage the spread of fires on large surfaces.



**Article 6.4.4. (1)** Open storage rooms for combustible liquids shall be located in areas lower than neighbouring objects and where, for technically justified reasons, the location is at a higher elevation, measures shall be taken to prevent the escape of combustible liquids to neighbouring objects and the transmission of fire to them.

**(2)** If open stores of combustible liquids are located in the vicinity of some waters (sea, river, lake, pond, etc.), measures shall be taken to prevent the flow of combustible liquids to them, but also to avoid flooding of deposits.

**Article 6.4.5.** Open deposits of combustible liquids shall include the zoning of fire and explosion risks.

**Article 6.4.6. (1)** Above-ground or semi-buried tanks (or groups of tanks) for combustible liquids that do not have double walls, shall have a retention tank bounded by dykes or continuous walls to withstand the mechanical and thermal stresses produced during fires.

**(2)** The retention tanks shall be dimensioned and made in such a way as to prevent the discharge of combustible liquids away from them.

**Article 6.4.7.** The storage of combustible liquids in packaging or containers may be carried out on open platforms made of materials of reaction to fire class A1, located above the level of the surrounding ground and delimited by drainage channels.

**Article 6.4.8. (1)** For external intervention in case of fire, open warehouses for combustible materials and substances with an area of more than 600 m<sup>2</sup> shall have access and intervention routes on four sides so as to ensure access and intervention of fire-fighting vehicles in case of fire, for 100% of the perimeter of the external warehouse. Open warehouses with an area of less than 600 m<sup>2</sup> may only have access on three sides, so as to ensure access and intervention by fire-fighting vehicles in the event of fire for at least 75% of the perimeter of the external warehouse.

**(2)** Access by intervention staff to open stores for combustible materials and substances shall be ensured by their functional circulations, duly marked.

## **CHAPTER 7**

### **7. BUILDING PERFORMANCE**

#### **WITH MIXED FUNCTIONS**

##### **7.1. COMMON BUILDING PERFORMANCE CONDITIONS (FIRE RISK, FIRE STABILITY LEVEL OF THE BUILDING)**

**Article 7.1.1. (1)** In multi-purpose buildings (civil, production and/or storage), the different functions are separated according to the functional and regulatory requirements.

**(2)** The distinct function (civil, production and/or storage) that exceeds 50% of the total built-up area of the construction (Da), determines its inclusion in construction with mixed civil functions or in construction with mixed functions of production and/or storage.

**3.** If the areas of the two functions are equal, the building will be considered to be the production and/or storage function.

**(4)** When the building has several different civil purposes, namely production and/or storage, the function with the largest total area of construction (Da) determines the civil function or the production or storage function of the building.

**Article 7.1.2.** According to the classification of the construction works, the fire safety measures laid down in the regulations for civil works or for production and/or storage works shall be ensured and the specific protective measures for each part of the construction shall also be complied with.

**Article 7.1.3. (1)** Areas, rooms, fire compartments and constructions with mixed functions will have the specific fire risks determined and specified, according to the provisions of Art. 2.1.2.2. and Art. 2.1.2.5.

**(2)** The most dangerous fire risk that represents more than 30% of the developed area (Da) of a construction portion (separated with fire-resistant walls and floors), determines the fire risk for the entire portion.

**(3)** The most dangerous fire risk of a stretch of construction, the area of which has been developed (Da) represents more than **30 %** in the developed area (Da) of that construction, determines the fire risk of the entire mixed-function construction.

**Article 7.1.4.** Constructions with mixed functions will have determined and specified the level of fire stability according to the provisions of **Art. 2.1.3.2.** and Table 3, also taking into account the conditions specific to the type of construction (tall, very tall or with crowded rooms, ordinary or special types of production/storage buildings).

## **7.2. BUILDING LOCATION AND COMPLIANCE**

**Article 7.2.1. (1)** Constructions with mixed functions are located at the safety distances provided in Art. 2.2.1.2. and Table 4, considering the whole constituted and the fire risk of the construction.

**(2)** Where normal safety distances cannot be ensured, the construction shall be subdivided from the surroundings in accordance with the provisions of the Rules.

**Article 7.2.2.** Through the fire compliance of buildings with mixed functions, the distinct arrangement of the different functions and the fulfilment of the correlation conditions between destination, fire risk, the level of fire stability ensured, the number of levels and the built-up area (Ba) of the construction, according to the provisions of Art. 2.2.2.2., Art. 3.1.2.6., **Art. 3.1.2.7.** and **Art. 6.1.2.2.** and Table 41, Table 42 **and** Table 114.

**Article 7.2.3. (1)** When the construction includes different, functionally independent and non-compartmentalized civil activities under the conditions provided for in Art. 7.4.2, the most severe performance conditions provided for in the regulations for the respective destinations are met, and if the functions are arranged in a high building, very high or with crowded rooms, the performance conditions specific to these types of buildings will also be met.

**(2)** In buildings with mixed civil, production and/or storage functions, it shall be ensured in each part that the performance conditions laid down in the regulations for that operation are met, taking into account their implications for the entire construction.

**(3)** In all cases, it shall be ensured that the possibilities for the slight spread of fire and smoke are limited both to the burnt portions and to those adjacent to the construction by other functions, taking the appropriate protective measures provided for in the regulations.

**Article 7.2.4. (1)** In multi-storey buildings with mixed production and/or storage functions, it is not recommended to place rooms with very high fire and volumetric explosion risks on the lower levels (above or below ground).

**(2)** The layout of rooms with very high risks of fire and volumetric explosion in buildings with mixed production and/or storage functions should be on the top floor of the building and only with appropriate protection measures. If for technical reasons it is not possible to arrange them at

the last level of construction, it shall be provided with fire resistant walls and floors and, where appropriate, to volumetric explosion, appropriately constituted and dimensioned.

### 7.3. LIMITING THE SPREAD OF FIRES

**Article 7.3.1. (1)** Independent destinations, arranged in mixed-function construction, shall be separated from each other and from the common routes for the functional circulation and evacuation of users by means of fire-resistant separating building elements, in accordance with the regulatory provisions.

**(2)** Where those destinations constitute separate fire compartments, their separation shall be carried out with fire resistant bulkheads separating fire compartments and, where appropriate, fire-resistant and volumetric explosion.

**(3)** The arrangement, design and construction of the separating building elements shall ensure the limitation of the spread of fire and smoke to adjacent functions during the normed time, and within the same functions shall ensure the limitation of the light spread of fire and smoke over large constructed areas.

**Article 7.3.2.** Building elements used to limit the spread of fire and smoke shall comply with the standardised performance requirements according to their role in the fire safety of the building.

**Article 7.3.3. (1)** Separation of different uses in multi-storey buildings with mixed functions shall be provided by EI/REI fire resistant walls and REI fire resistant floors appropriate to the most *dangerous* fire risk and the heat load density ( $q$ ) in the adjacent rooms, and any functional circulation and escape gaps in the separating elements shall be protected by closure elements as specified in the standard.

**(2)** Limiting the spread of fire between different functions in a multi-storey building is provided on the facades (outside perimeter enclosures) and through the interior of the building.

**(3)** The requirements for performance of construction elements intended to limit the spread of fire and smoke shall be those laid down in the Rules.

**Article 7.3.4.** The common functional movement and evacuation routes of construction users with mixed functions (horizontal and vertical) shall be separated from the different adjacent functions corresponding to the function requiring the most severe conditions, the fire risk and the density of the heat load ( $q$ ) and any operating and exhaust gaps in these separation elements shall be protected by closing elements that meet the standard conditions.

**Article 7.3.5.** Parking lots for cars can be arranged in constructions with mixed functions, provided they are separated from the rest of the construction by fire-resistant elements, respectively EI/REI walls and appropriate REI floors, and only strictly necessary gaps for access and circulation are allowed in these separating elements, properly protected.

**Article 7.3.6. (1)** The evacuation of smoke and hot gases in case of fire is mandatory in the rooms established in the regulations, according to their specific destination and the type of construction with mixed functions.

**(2)** The composition and construction of the systems intended to evacuate smoke and hot gases in case of fire, through natural-organized draft or through mechanical ventilation, must correspond to the provisions of the Rules and the provisions of the technical regulations.

**(3)** Parts of constructions with distinct functions shall be provided with independent devices for the evacuation of smoke and hot gases in the event of fire, separated from those for the discharge of smoke and hot gases in the event of fire from other functions.

**(4)** In technically justified cases, for different functions with the same fire risk arranged in the construction with mixed functions, common smoke and hot gas exhaust installations can be

made in case of fire in case of fire, provided that protective measures are taken to ensure the limitation the propagation of fires between destinations through the pipes that pierce their separating elements (walls, floors).

**Article 7.3.7.** The evacuation of smoke and hot gases in the event of fire from the common escape routes of construction users with mixed functions (horizontal and vertical) shall be carried out with their own systems independent of those of other rooms or building functions.

**Article 7.3.8.** It is mandatory to carry out the evacuation of smoke and hot gases through an independent system in case of fire from crowded rooms, warehouses for materials and/or combustible substances, as well as from rooms and spaces with a high or very high risk of fire.

**Article 7.3.9.** When the garbage cans and channels for smoke evacuation from a room pass through other rooms or destinations, along the entire passage, the walls of the channels will be fire resistant according to the heat load density ( $q$ ) in that space, but at least EI 120 (ve and /or ho)  $S_{multi}$ . Vertical garbage cans through which the exhaust pipes and hot gases in the event of fire pass through other levels of construction will satisfy the conditions laid down in **Article 2.4.11.2**.

**Article 7.3.10.** Evacuation of smoke and hot gases in the event of fire from closed above-ground escape stairwells of buildings with mixed functions and without direct windows to the outside, is ensured by natural-organized draft or put under overpressure, and for underground ones it can be achieved by natural-organized draft or through or are put under overpressure, under the conditions and in compliance with the provisions of the normative and specialized technical regulations.

## 7.4. CONSTRUCTIVE ASSEMBLIES

**Article 7.4.1.** Constructions with mixed functions conform and are made of materials, products and construction elements that ensure the fulfilment of the normed correlation conditions and do not spread fire easily.

**Article 7.4.2. (1)** The different functions in the construction are separated with EI/REI walls and, as the case may be, REI floors, with fire resistances determined according to the fire risk and the heat load density ( $q$ ) of the rooms they separate, according to the provisions of the regulations and the Annex regarding '*Classification of stored materials/products and substances, according to the hazard class*', as well as the performance conditions specific to the destination and type of building.

**(2)** Any internal gaps of the construction elements will have their continuity interrupted, according to the regulations, so as not to favour the propagation of fire and smoke on large built-up areas and between different functions of the construction.

**Article 7.4.3.** By establishing and carrying out separate parts of construction with distinct functions (civil, production and/or storage), the performance conditions specific to each function will be met and the entire construction with mixed functions will meet the performance conditions corresponding to the set up.

**Article 7.4.4.** Storage rooms for combustible materials and substances shall be constructed, carried out and separated from the rest of the construction in accordance with the provisions of the Rules.

**Article 7.4.5.** In the admitted situations, the rooms with a very high risk of fire are laid out, made up, realized and used in such a way as not to endanger the construction, ensuring the protection measures corresponding to the provisions of the Rules and technical regulations.

**Article 7.4.6.** The construction portions that include or constitute crowded rooms will be made up in accordance with the provisions regarding their specific performances, separating from other functions of the construction by EI/REI walls and, as the case may be, fire-resistant REI floors, in accordance with the normative provisions.

**Article 7.4.7.** Underground parts of buildings with mixed functions in which functions are distinct from those above ground shall also fulfil the conditions specific to these functions.

## **7.5. ESCAPE ROUTES FOR USERS IN CASE OF FIRE**

**Article 7.5.1.** In constructions with mixed functions, there are an appropriate number of escape routes for users in case of fire, arranged, made up and dimensioned according to the respective destination and the normative provisions.

**Article 7.5.2. (1)** The escape routes of the multi-function construction may be specific to a function or a group of functions or common to all functions of the construction.

**(2)** In mixed-function constructions with different destinations arranged in distinct areas of construction, the times (lengths) of the escape routes shall meet the performance corresponding to each function. Where the escape routes are common to more than one or all of the functions of the construction, the number, arrangement, dimensioning and composition shall satisfy the most severe performance requirements of the respective functions for which evacuation is ensured. In portions or areas of the construction where an operation determines the smaller dimensions of the escape routes, the width of the escape routes in that portion or zone may be reduced accordingly.

**Article 7.5.3. (1)** The separation of the functional and evacuation routes of users from adjacent rooms shall be carried out in accordance with the conditions laid down for that function and the type of building.

**(2)** The access gaps to the escape routes in their dividing walls are protected with closing elements corresponding to the risk of fire, the destination of the adjacent rooms and the type of building, according to the regulations.

**Article 7.5.4.** The common internal escape ladders of mixed-function buildings shall be closed in staircase houses, separated from the rest of the construction by fire resistant elements, in accordance with the function requiring the most severe conditions. Open internal ladders (not enclosed in staircases) may be provided only in the cases and under the conditions laid down in the legislation, taking into account the above mentioned requirements.

**Article 7.5.5.** In constructions with mixed functions, escalators made according to the provisions of Art. 2.5.6.3.3. can be provided, provided that there are also escape routes for users through closed stairs.

**Article 7.5.6.** The ramps of the internal stairs related to the basements are separated from the ramps of the above-ground stairs, except for the situations mentioned in the Rules (Art. 2.5.6.2.3. paragraph (3)).

**Article 7.5.7.** Internal circulation and vertical transport routes (stairs, lifts, loading ramps, etc.) are separated from the rest of the building by EI/REI walls and, as the case may be, REI floors that meet the standard fire resistance conditions, and the access gaps practiced in the separation walls, they are protected with closing elements, according to the regulations.

**Article 7.5.8.** When open external escape stairs are provided, they are located and made so that the movement of users is not blocked by the flames or smoke produced in the event of a fire in the construction with mixed functions or in the constructions located in the vicinity.

**Article 7.5.9. (1)** Determination of user evacuation (flow) units in the event of fire on common functional and evacuation routes, consider the building as a whole and ensure the most stringent standard protection measures.

**(2)** When provision is made for separate evacuation routes specific to a similar function or group of functions, the conditions laid down for that destination shall be followed when determining the discharge pass-through units (streams).

**Article 7.5.10. (1)** The determination of the number of users for whom evacuation is provided in the event of fire shall take into account the occupancy level and the maximum simultaneous capacity of users, depending on their intended use and layout under construction.

**(2)** Expected number of users per exhaust passage (flow) unit (**Uf**) it shall be determined according to each of the functions considered, in accordance with the provisions of the Rules, and for the entire construction, the common escape routes shall ensure the most stringent standard conditions.

**Article 7.5.11.** If above the level of the above-ground construction, which determines the dimensioning of the escape staircase ramps, there are functions that require their smaller dimensions, these dimensions can be reduced accordingly in the respective portions of the construction. In all cases, on the escape route to the outside of the most congested level considered, it shall not be permissible to reduce the dimensions of the escape routes.

**Article 7.5.12.** The maximum permissible exhaust lengths on escape routes shall satisfy the conditions laid down in the legislation for the function in question, and for the common functional and exhaust routes of the construction the most severe standard lengths shall be observed.

**Article 7.5.13.** The composition and dimensioning of escape routes in the event of fire shall comply with the requirements laid down in the legislation.

**Article 7.5.14.** The enclosed internal evacuation ladders of mixed-function buildings shall have access to the terraces of the buildings concerned, when they are high or very high buildings, in accordance with the provisions of the Rules.

## **7.6. FIRE ACCESS, RESPONSE and RESCUE CONDITIONS**

**Article 7.6.1. (1)** Constructions with mixed functions must have access, intervention and rescue routes in case of fire, arranged, designed and built in such a way that the intervention forces can act in a short time and in safe conditions.

**(2)** The construction works must be accessible to intervention vehicles in the event of fire according to their intended purpose, the type of building and the conditions laid down in the Rules.

**(3)** The access possibilities for emergency vehicles (roads, platforms, etc.) must allow access and intervention especially to the more dangerous areas and functions of the construction, to those with people crowds, to the openings (protected or unprotected) in the outer perimeter walls, as well as at water supply sources.

**(4)** The number, composition, compliance and realization of the external access and circulation possibilities of the intervention vehicles will correspond to the provisions of the Rules.

**(5)** Internal access and functional movements, which also ensure intervention in the event of fire, shall be suitably equipped and marked so as to facilitate their recognition and use in the specific conditions of fire intervention.

(6) For destinations of the construction with mixed functions, which require special conditions for rescuing users in case of fire (children, sick, disabled persons, etc.), the circulation and rescue routes will be appropriately sized, constructed and equipped, according to the provisions normative and specialized technical regulations.

**Article 7.6.2.** Constructions with mixed functions will have access possibilities for emergency vehicles at least on two sides so as to ensure the access and intervention of fire extinguishing vehicles in case of fire, at least on **50%** of the perimeter of the external walls, and those with the built area (**Ba**) smaller than **600 m<sup>2</sup>**, on one side in such a way as to ensure the access and intervention of firefighting vehicles in case of fire, at least on **25%** of the perimeter of the external walls.

## **7.7. EQUIPPING BUILDINGS WITH FIRE-FIGHTING INSTALLATIONS AND APPLIANCES**

**Article 7.7.1.** Mixed-function buildings shall be equipped with fire-fighting systems and means, as well as fire detection, signalling and alarm systems, in accordance with the provisions of the specialised technical regulations.

**Article 7.7.2.** Mixed-function constructions shall be equipped with portable extinguishers with extinguishing performance corresponding to the classification of the construction (differentiated in the regulations for civil works or for production and/or storage structures), and for each part of the construction the provisions on performance specific to that function are also complied with.

## **CHAPTER 8**

### ***SMOKE AND HOT GAS EVACUATION SYSTEMS IN CASE OF FIRE***

#### **8.1. General provisions**

**Article 8.1.1. (1)** In order to ensure the evacuation conditions of users, to limit the propagation of fire and to facilitate fire-extinguishing intervention, in addition to the structural separation elements provided (walls, floors, etc.) in the situations specified in the regulations, provision is made for smoke and hot gas evacuation systems, screens, as well as barriers, overpressure, etc.

**(2)** The purpose for which it is designed shall be clearly defined and the design documentation shall indicate whether the smoke and hot gas exhaust systems will serve as:

- how to protect escape routes (to specify access and discharge free from smoke and radiant heat); or
- how to protect goods (protective equipment and endowment to reduce damage caused by thermal decomposition products, hot gases and thermal radiation); or
- how to control the temperature of hot gases in smoke affecting, for example, building structure, facades or glazed surfaces; or
- how to facilitate extinguishing operations by creating a smoke-free layer; or
- a combination of any of the above.

**(3)** The evacuation of smoke and hot gases in the event of fire shall be carried out by natural draught – organised or by mechanical ventilation. By evacuating smoke and hot gases in the event of fire through an organised natural system or mechanical system, the aim is to extract smoke from the upper part of the burned enclosure and to inhabit the volume of smoke extracted with fresh air.

(4) The smoke evacuation systems of the above-ground building levels shall be independent of those of the underground levels.

(5) The release of smoke through natural and mechanical systems simultaneously into the same smoke tank shall not be permitted.

(6) An exhaust system for smoke and hot gases shall consist of:

- a) a natural exhaust system with a natural intake air supply system; or
- b) a mechanical exhaust system with a natural intake air supply system; or
- c) a natural exhaust system with a mechanical intake air supply system; or
- d) a mechanical exhaust system and a mechanical intake air supply system (tandem system).

The latter shall not be designed unless a detailed and technical description is available showing how the system works under calculation conditions.

**Article 8.1.2. (1)** As an alternative to the provisions of these Rules, the complex design of smoke and hot gas exhaust systems for non-standardized structures or buildings where the large dimensions, shape or configuration make smoke control necessary and according to the design criteria or at the request of the competent authorities, appropriate performance levels regarding the height of the layer are required of smoke-free air, the temperature of the air layer, external influences, etc., (in tall and very tall buildings, in malls with one or more floors; super/hypermarkets; industrial buildings with one or more floors and storage buildings protected by sprinkler; atrium buildings and complex mixed buildings; closed car parks; stairs; buffer rooms, theatres, etc.), as well as any other desired investment, can be done based on the SR CEN/TR 12101-5 standard - Smoke and hot gas control systems. Part 5: Guidelines for functional recommendations and calculation methods for ventilation systems for the evacuation of smoke and hot gases and based on standards **SR EN 12101-6** -Smoke and heat control systems Part 6: Specification for pressure differential systems. Kits and **SR EN 12101-13** -Smoke and heat control systems Part 13: Pressure differential systems (**PDS**). Design and calculation methods, installation, acceptance testing, routine testing and maintenance.

(2) Where the Rules provide for overpressure ventilation, the design and calculation of the system may be made alternatively on the basis of standards **SR EN 12101-6** -Smoke and heat control systems. Part 6: Specification for pressure differential systems. Kits and **SR EN 12101-13** -Smoke and hot gas control systems. Part 13: Pressure differential systems (**PDS**). Design and calculation methods, installation, acceptance testing, routine testing and maintenance.

(3) The overpressure is set so that the pressure on the doors is not less than 30Pa and not more than **80Pa**.

**Article 8.1.3. (1)** The exhaust system for smoke and hot gases can be realised with natural-organised draught or mechanical ventilation.

(2) The smoke and hot gas exhaust system consists of air inlets in the lower part (lower third) of the protected space, continuous fire-resistant screens of at least DH 30, lowered below the roof or the upper floor of the protected space by at least 50 cm, and smoke and hot gas outlets in the upper third of the walls or in the roof.

(3) Air inlet and smoke discharge gaps shall be distributed alternately, distributed as evenly as possible within the protected space in such a way as to ensure air circulation and smoke discharge, meeting the specific conditions laid down in the legislation.

(4) Air inlets can be provided by:

- a) stairways not enclosed in stairwells;
- b) gaps in facades, permanently open or with automatic opening, e.g. doors, windows, air intake ventilators;
- c) doors with automatic opening of rooms that are prevented with a smoke and hot gas evacuation system in the event of fire, in the external walls of the building;
- d) insertion gaps permanently open or with automatic opening, whether or not connected to channels and cheques;



- e) a combination of any of those listed in point b, c, d; or
- f) a mechanical injection power using fans (and tubing if indicated).

(5) The intake air shall always be below the smoke layer when it comes into contact with the smoke and shall not be used simultaneously as the same opening as the outlet (exhaust) and as the input (inlet). Air inlet gaps shall be positioned to ensure that the introduced air does not influence any smoke layer in the smoke tank, thus allowing hot smoke gases to cool and descend or become more turbulent.

(6) Smoke evacuation shall be provided through gaps in the roof or in external walls, in accordance with the provisions laid down in the Rules.

(7) Smoke and hot gas exhaust system is not mandatory in areas less than **30 m** from the external walls of the construction, which have in the upper third permanently open gaps or protected by devices which automatically open in the event of fire and provide the standard free surface for the evacuation of smoke by means of organised natural draught, and in the external fields they have devices for inserting fresh air size corresponding to the Rules.

**Article 8.1.4. (1)** Inlet or outlet protection devices shall be operated automatically and manually in accordance with the provisions of the legislation. Automatic operation of protective devices shall always be accompanied by manual control. Manual control shall be performed both centrally, for all smoke and hot gas exhaust systems in the fire compartment where the fire was detected, and locally. In constructions equipped with automatic extinguishing systems, actuation possibilities shall be provided for personnel present in the protected space and capable of manually controlling smoke and hot gas exhaust systems.

(2) The actuators of the inlet and outlet shut-off devices must ensure:

- a) opening of gaps and channels from protected volume;
- b) stopping fans which are not intended to evacuate smoke in the event of fire;
- c) starting of smoke evacuation fans and compensating air injection fans, as

appropriate.

(3) Manual control of opening devices may be achieved by mechanical, electrical, pneumatic or hydraulic system.

(4) Depending on the type of construction and the specific performance provisions, the centralised manual control shall be placed at the emergency service (when required) or main access to the construction.

(5) Automatic control of gap protection devices shall be provided by the fire detection, signalling and alarm system or local devices, where no such installation is provided.

**Article 8.1.5.** The entry into operation of any smoke and hot gas exhaust system in the event of fire shall automatically interrupt the operation of the normal ventilation and air-conditioning systems of the construction.

**Article 8.1.6** The entry into operation of any smoke and hot gas exhaust system in the event of fire shall be made after the automatic extinguishing installations have entered into operation.

**Article 8.1.7. (1)** Smoke exhaust systems in the event of fire are incompatible with gas or powder extinguishing systems for which provision is made for ventilation of the spaces into which the extinguishing agent has been discharged.

(2) In use, the rules for checking and maintaining smoke and hot gas exhaust systems in case of fire shall be observed.

**Article 8.1.8. (1)** Smoke and hot gas evacuation (natural-organized, mechanical, mixed, pressurization) in case of fire shall be provided at:

- a) crowded rooms;
- b) scenes with an area greater than **150 m<sup>2</sup>** and their pockets with heights greater than **10 m**;
- c) enclosed stairwells and buffer rooms (by means of overpressure)

for access to stairwells in high-rise, very high-rise and healthcare buildings (regardless of height regime), as well as lift shafts for the evacuation of people with disabilities or with wheelchairs and lifts for the evacuation of sick people with wheelchairs, stretchers or wheelchairs;

**d)** enclosed stairwells and horizontal common circulation that do not have direct windows to the outside through which smoke can escape in the event of a fire, from buildings/fire compartments with crowded rooms;

**e)** above-ground enclosed stairwells that do not have windows directly to the outside and provide for the evacuation of users of more than one level of the building and underground enclosed stairwells that do not have windows opening directly to the outside;

**f)** enclosed stairwells arranged in underground buildings that have no direct windows to the outside;

**g)** closed atriums, in accordance with regulatory provisions;

**h)** protected discharges or tunnels for the evacuation of users from constructions for any purpose (overpressure) or from buffer rooms;

**i)** rooms, compartments and production and/or storage buildings with an area larger than **36 m<sup>2</sup>** and with a heat load density greater than **105 MJ/m<sup>2</sup>**;

**j)** storage rooms for combustible materials and/or substances in civil buildings with thermal load density (**q**) over **105 MJ/m<sup>2</sup>** and area greater than **36 m<sup>2</sup>**;

**k)** underground car parks, in accordance with the specific technical regulation, and above ground car parks, in accordance with the regulatory provisions;

**l)** open parking spaces according to **Art. 3.2.11.21 paragraph 3**;

**m)** rooms with a very high risk of fire located underground, regardless of their area;

**n)** rooms with useful area larger than **36 m<sup>2</sup>** and thermal load density greater than **105 MJ/m<sup>2</sup>** located underground

**o)** rooms in underground civil buildings in which more than **50** users may be simultaneously accommodated and their escape routes through which more than **50** users may be evacuated simultaneously;

**p)** horizontal common movement longer than **30 m** which do not have windows directly outwards to evacuate smoke in the event of fire (located in such a way as to ensure the evacuation of smoke and hot gases in the event of fire to a maximum extent; **30 m** depth of horizontal common circulations), when adjacent rooms are not provided with windows or smoke discharges by natural, organised or mechanical system. When adjacent rooms are provided with windows or smoke discharges, horizontal common circulations no longer require smoke and hot gas evacuation systems in the event of fire;

**q)** horizontal common movement in raised buildings according to **Article 4.1.5.12.** and from very high buildings according to **Article 4.2.5.12.**

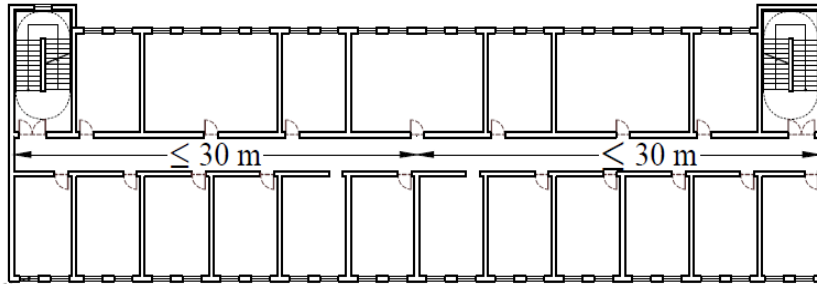
**r)** above-ground closed production and/or storage constructions with built area (**Ba**) of at least **20,000 m<sup>2</sup>** and width greater than **72 m** (rooms, fire compartments and buildings larger than **36 m<sup>2</sup>** and thermal load density greater than **105 MJ/m<sup>2</sup>**)

**s)** above-ground production and/or storage constructions closed with a built-up area (**Ba**) greater than **1,000 m** and where the activity is

carried out only in artificial light, with full perimeter roof and closing walls, in which only psychological gaps and access doors are provided (rooms, fire compartments and buildings larger than **36 m<sup>2</sup>** and thermal load density greater than **105 MJ/m<sup>2</sup>**)

t) other buildings, rooms and spaces referred to in the Rules.

*Note: Provision of smoke and hot gas exhaust systems for horizontal common circulation when required shall be done in accordance with Figure 77.*

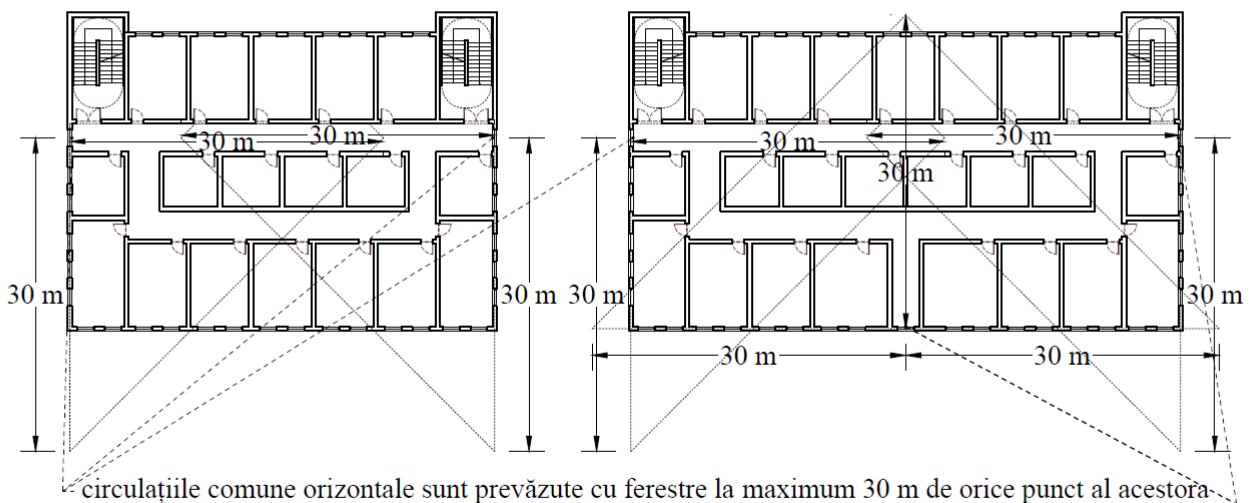
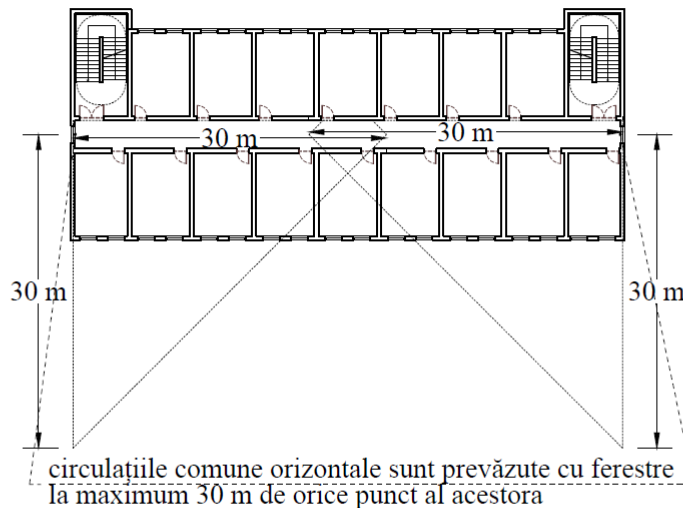


toate camerele perimetrare circulațiilor comune orizontale sunt prevăzute cu ferestre

toate camerele perimetrare circulațiilor comune orizontale sunt prevăzute cu ferestre

all perimeter cameras of horizontal common circulations are fitted with windows

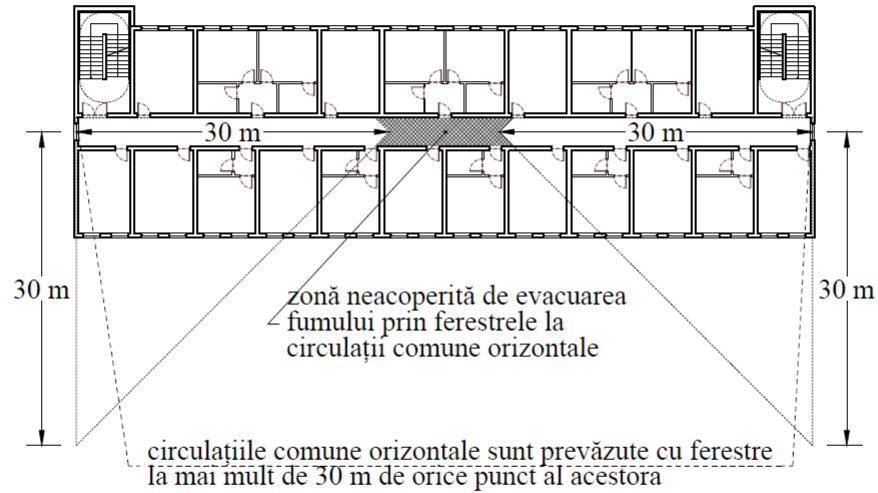
***Variant a) when adjacent rooms are provided with smoke evacuation (naturally organised through windows or mechanically) the horizontal common circulation does not require the provision of smoke evacuation systems***



circulațiile comune orizontale sunt prevăzute cu ferestre la maximum 50 m de orice punct al

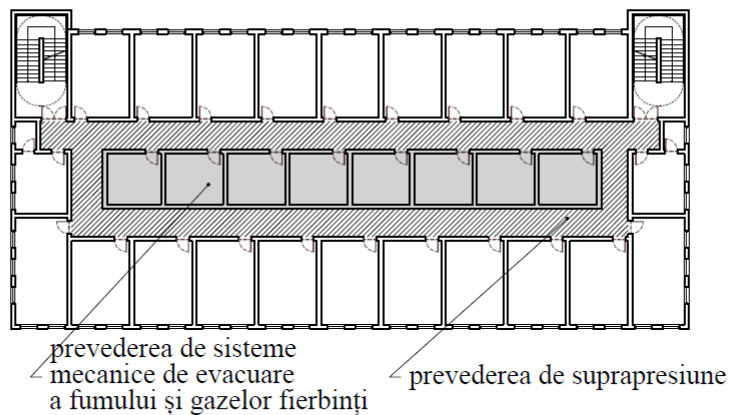
horizontal common circulation shall be provided with windows not more than 50 m from any point thereof

**Variant b) when windows of horizontal common circulations are located in such a way as to ensure the evacuation of smoke and hot gases in the event of fire up to 30 m depth, horizontal common movements no longer require the provision of smoke evacuation systems**



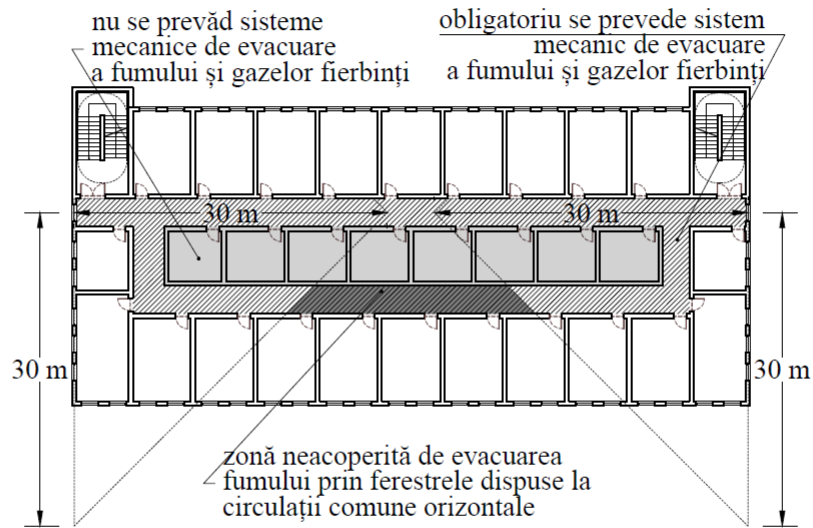
zonă neacoperită de evacuarea fumului prin ferestrele la circulații comune orizontale	area not covered by smoke evacuation through horizontal common movement windows
circulațiile comune orizontale sunt prevăzute cu ferestre la maximum 30 m de orice punct al acestora	horizontal common circulation shall be provided with windows not more than 30 m from any point thereof

**Variant c) where the windows of horizontal common circulations are located at a depth of more than 30 m, provision shall be made for a mechanical air intake and exhaust system for smoke and fumes**



prevederea de sisteme mecanice de evacuare a fumului și gazelor fierbinți	provision of mechanical smoke and hot gas exhaust systems
prevederea de suprapresiune	overpressure provision

**Variant d) where rooms that do not have windows directly on the outside through which smoke can be evacuated in the event of fire are provided with a mechanical inlet and outlet system for smoke and fumes, horizontal common circulations may be pressurised**



nu se prevăd sisteme v mecanice de evacuare a fumului și gazelor fierbinți	no provision is made for mechanical exhaust systems for smoke and hot gases
obligatoriu se prevede sistem mecanic de evacuare 7 a fumului și gazelor fierbinți'	mechanical smoke and hot gas exhaust system 7 is mandatory
zonă neacoperită de evacuarea fumului prin ferestrele dispuse la circulații comune orizontale	area not covered by smoke evacuation through horizontal common movement windows

**Variant e) where the windows of horizontal common circulations are more than 30 m deep and the rooms that do not have windows directly outside through which smoke can be evacuated in the event of fire are not provided with a mechanical system for the intake and evacuation of smoke and fumes, the common circulations must be equipped with a mechanical system for the intake and evacuation of smoke and fumes**

**Figure 77 - Provision of smoke and hot gas exhaust systems at horizontal common circulations**

**Article 8.1.9. (1)** Where the regulations specify the existence of direct external windows for the escape of smoke and hot gases in the event of fire from stairwells and common horizontal escape routes, these functional windows shall be located on each storey, shall have a free aerodynamic area of not less than 1 m<sup>2</sup> and shall be provided with manual operation not more than 1.50 m above the floor. The air intake is made through the access door in the stairwell from the outside of the building or through another system provided by the designer according to **Art. 8.1.1. paragraph 6**, except for in situations where the doors do not protect gaps that have the role to limit the transmission of fire to or from the outside.

**(2)** When the normative content mentions the existence of windows directly outside through which the smoke is evacuated from the common horizontal exhaust circulations (located at less than **30 m** in depth), these functional windows must have a free aerodynamic area of at least **1.00 m<sup>2</sup>**, to be arranged at the ends of the corridors and provided with manual operation arranged at least **1.50 m** from the floor. Automatic actuation is also foreseen when the building is equipped with an automatic fire detection system.

**(3)** When the normative content mentions the existence of windows directly to the outside through which the smoke is evacuated from the rooms, with the exception of common horizontal exhaust circulations (located at less than **30 m** in depth), these functional windows must have an aerodynamic area free of minimum **1.00 m<sup>2</sup>**, to be arranged at the ends of the corridors and provided with manual operation arranged at a minimum of **1.50 m** from the floor. Automatic actuation is also foreseen when the building is equipped with an automatic fire detection system. Air intakes shall be made by dispositions located on different facades or opposite to those on which the smoke evacuation devices (functional windows) are located, under the conditions laid down by the legislation.

**(4)** When the normative content mentions the existence of direct windows to the outside

through which the smoke is evacuated, in all cases these functional windows must have a free aerodynamic area of at least **1.00 m<sup>2</sup>**, be located at the ends of the corridors and be equipped with manual actuation located at minimum **1.50 m** from the floor.

(5) Buffers shall be pressurised according to standards **SR EN 12101-6** -Smoke and heat control systems Part 6: Specification for pressure differential systems. Kits and **SR EN 12101-13** -Smoke and heat control systems Part 13: Pressure differential systems (**PDS**). Design and calculation methods, installation, acceptance testing, routine testing and maintenance.

**Article 8.1.10. (1)** The exhaust of smoke and hot gases in the event of a fire must ensure upward air circulation in the room and exhaust of smoke in relation to the air introduced.

(2) The evacuation of smoke and hot gases in the event of fire shall be ensured by organised natural draught or mechanical ventilation. Free aerodynamic surface of devices with automatic opening for smoke evacuation in case of natural fire – organised draught shall be at least **1 %** from room area

(3) The smoke and hot gas exhaust system in the event of a fire shall be provided by means of alternating smoke outlets and fresh air inlets.

(4) Smoke vents in the event of fire, made and sized in accordance with the provisions of the standard and technical regulations, shall be located in the upper third of the walls of the room, with the lower part of the grille located at least 1.80 m above the floor or in the roof provided in the upper third of the roof, referred to the maximum height of the roof. Smoke vents can communicate directly with the outside or through ducts (fire resistant smoke vents) or smoke vents (Figure 78), taking into account pressure losses on the ducts and niches.

(5) The air inlet is through air inlets at the bottom (in the lower third of the walls) of rooms/spaces equipped with smoke and hot gas exhaust systems in case of fire, with their upper edge not more than 1 m above the floor for rooms/spaces with a maximum clear height of 3 m, which may communicate with the outside directly or through air inlet ducts or vents (Figure 78). The air inlet shall be through air inlets in the lower third of the walls of rooms/spaces provided with smoke and hot gas exhaust systems in case of fire for rooms/spaces with a clear height of more than 3 m, which may communicate with the outside directly or through air inlet ducts or vents (Figure 78).

(6) The air inlet for any smoke evacuation system in the event of fire, may be natural or, if mechanical, shall be **75 %** from the exhaust smoke volume flow rate (with a tolerance of plus or minus **10 %**). In the case of an organised natural draught system, the aerodynamic surface of the air inlet ports shall be minimal **75 %** from the free surface of the smoke and fibre-gas evacuation devices. When establishing the calculation rates in mixed variants, the introduction of natural compensation air and mechanical discharge shall be considered as a speed of **1 m/s** at the introduction ports/devices, i.e. the introduction of air mechanical compensation and natural discharge, a speed of **1 m/s** at drainage ports/devices.

(7) The rooms that have doors or grills directly outside the building and meet the condition of **paragraph 6**, it is considered to ensure the air intake necessary for the evacuation of smoke and hot gases in case of fire, if they are equipped with automatic and manual opening devices in case of fire.

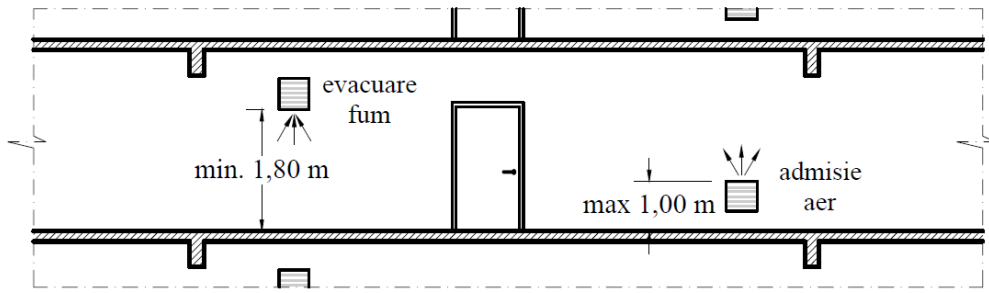
(8) Smoke exhaust and air intake openings in case of fire can be permanently open (grills) or closed, with devices that open automatically in case of fire (hatches, smoke exhaust windows or shutters) and are provided and with manual actions.

(9) Any of the fire escape or air intake openings shall have the smallest dimension of at least 0.20 m.

(10) The opening of the smoke and hot gas exhaust devices in case of fire is ensured automatically, individually or in groups, and the opening of the air intake devices will also operate.

(11) When provided, in the room equipped with smoke and hot gas exhaust devices in case of fire, the shutters shall be at least fire resistant at least **EI60<sub>multi(i..o)</sub>** at the smoke exhaust openings and fireproof at the little **E<sub>600</sub>60<sub>single(i..o)</sub>** at air inlets, normally closed in standby position. The provision of flaps is not mandatory in situations where the smoke is evacuated from a single level or

the related piping serves a single level of the construction.



evacuare fum	smoke discharge
min. 1,80 m	min. 1.80 m
max 1,00 m	max 1.00 m
admisie aer	air intake

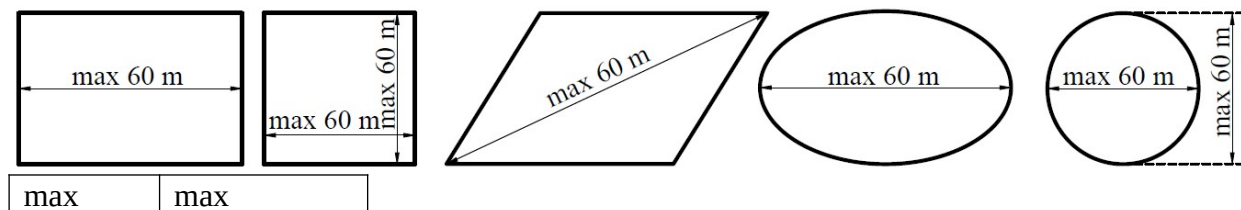
**Figure 78 - The height arrangement of the smoke exhaust and air intake openings for rooms/spaces with a maximum free height of 3m**

**Article 8.1.11.** Smoke and hot gas evacuation devices in case of fire through natural-organized draft, located in the external walls or roof of the building (gaps, grills, hatches, windows with automatic opening, shutters), can ensure the evacuation of smoke from the respective room on maximum distance of 30 m.

**Article 8.1.12. (1)** The screens lowered under the roof or under the upper floor of the protected space, in the natural draught system, are arranged according to the provisions laid down, with smoke reservoirs. Smoke tanks are separated by minimum smoke barriers **DH30** or structural constructional elements with minimum fire resistance of **30** minutes. The geometrical boundaries of a smoke tank may be given by all building elements (opaque internal or external walls, glazed elements, beams or screens, etc.) separating the space in smoke and hot gas evacuation areas. In all cases, the boundaries of the areas for which the smoke discharge calculation is made shall be at least the same time as the fire resistance and the same height as defined in the particular cases within the Rules.

**(2)** The continuous screens shall be attached to the building resistance elements in the potential fire risk area.

**(3)** The maximum length of the smoke tank along any axis shall not exceed **60 m** (according to Figure 79).



**Figure 79 - Maximum length of the smoke tank**

**Article 8.1.13.** If the fire is directly below the smoke tank, the maximum area of any tank must not exceed 2,000 m<sup>2</sup> if there is a natural-organized smoke exhaust system or 2,600 m<sup>2</sup> if there are mechanical smoke exhaust fans. If the fire is in a room adjacent to the space containing the tank or is below an enclosed mezzanine in the same space (e.g. single and multi-storey malls and atriums), the maximum area of the burning room (or overhang) allowed to cause the flue gases to flow in the smoke tank must be 1,000 m<sup>2</sup> if there is natural smoke exhaust or 1,300 m<sup>2</sup> if there are mechanical smoke exhaust fans. The maximum area of the smoke tank must be 1,000 m<sup>2</sup> if there is natural smoke exhaust or 1,300 m<sup>2</sup> if there are mechanical smoke exhaust fans.

**Article 8.1.14. (1)** In multi-storey buildings, smoke exhaust in the event of fire (of the upper storeys) is generally provided separately for each storey of the building and the common collecting ducts (single or multi-storey fire resistant smoke exhaust ducts) passing through other storeys of the building must meet one of the following conditions set out in Table 118:

**Table 118: Use of exhaust pipes for smoke and hot gases in the height of the construction**

	<b>Collecting pipes on building height</b>			
	<i>In multi-storey buildings without fireproof floor slabs cutting (ve)</i>		<i>In multi-storey buildings with fireproof floor slabs cutting** (ve)</i>	
	<b>pipes</b>	<b>Shutters at the entrance to the collector channel</b>	<b>pipes</b>	<b>Shutters at the entrance to the collector channel</b>
<b>I</b>	$E_{600} 120^*_{ve} S_{single}$	$E_{600} 120_{single(i \rightarrow o)}$	$EI 120^*_{ve} S_{multi}$	$EI 120_{multi(i \rightarrow o)}$
<b>II</b>	$E_{600} 120^*_{ve} S_{single}$	$E_{600} 120_{single(i \rightarrow o)}$	$EI 120^*_{ve} S_{multi}$	$EI 120_{multi(i \rightarrow o)}$
<b>III</b>	$E_{600} 90^*_{ve} S_{single}$	$E_{600} 90_{single(i \rightarrow o)}$	$EI 90^*_{ve} S_{multi}$	$EI 90_{multi(i \rightarrow o)}$
<b>IV</b>	$E_{600} 60^*_{ve} S_{single}$	$E_{600} 60_{single(i \rightarrow o)}$	$EI 60^*_{ve} S_{multi}$	$EI 60_{multi(i \rightarrow o)}$

Notes:

\* - the gap between the floor and pipes is sealed with materials in fire-resistant compositions of at least **EI** with the same value as the standard fire resistance of the floors they intersect;

\*\* - the gap between the fire-resistant floor and pipes is sealed with materials in fire-resistant compositions of minimum **EI** with the same value as the standard fire resistance of the fire-resistant floor they intersect;

**(2)** In the case of the use of common collector channels (fire-resistant pipes) for the evacuation of smoke and hot gases in case of fire of all above-ground or underground levels of buildings, the vertical niches through which the collector channels of the smoke and hot gas exhaust system in case of fire respective fire crosses other levels of the construction will meet the conditions provided for in **Art. 2.4.11.2.** and the specific requirements of each destination in relation to the construction characteristics according to the standard (example: tall and very tall buildings, underground parking lots, etc.).

**(3)** In the case of the use of common collector channels (fire-resistant pipes) for the evacuation of smoke and hot gases in the event of a fire of all above-ground or underground levels of tall or very tall buildings, the eaves will be protected with walls of fire reaction class **A1, A2s1d0** minimum fire resistance **EI 180** and hatches and access doors in the walls of the vertical niches must be made of **A1, A2s1d0** materials with fire resistance **EI 90**.

**(4)** The envisaged shutters at the entrance to the collecting channel will be normally closed, in a waiting position.

**Article 8.1.15.** In constructions provided with skylights, the evacuation of smoke and hot gases in case of fire can be ensured through their movable meshes, which have provided for automatic opening in case of fire and meet the specific conditions of smoke evacuation devices. The natural and organised air intake shall take place within the perimeter, corresponding to the Rules.

**Article 8.1.16.** Smoke screens are not mandatory when the following conditions are simultaneously met:

- the density of the heat load in that room shall not be greater than **420 MJ/m<sup>2</sup>**;
- the slope of the roof is greater than **20°** and not required by horizontal separators, according to **Figure 13** from terminology;
- hatches are provided in the upper third of the slope relative to the maximum height of the slope.



## 8.2. Natural draught smoke evacuation - organised

**Article 8.2.1. (1)** The evacuation of smoke through natural-organized draft is carried out through air inlets and smoke evacuation gaps that can communicate with the outside directly or through natural channels, so arranged, dimensioned and made as to ensure the controlled circulation of air in the protected volume and the evacuation of smoke.

**(2)** The introduction of air is carried out through intake gaps with the useful free aerodynamic area of **75%** of the useful free aerodynamic area of the exhausts, and the exhaust of smoke through gaps in the facades (free or closed with devices that open automatically in case of fire), through ducts and niches, or through devices (hatches) with automatic opening located in the upper third of the frame, related to the maximum height of the frame, or in the upper third of the external walls of the room (when the ceiling has an inclination of less than **20°**). The smoke exhaust devices through natural-organized draft ensure the exhaust of smoke over a maximum depth of **30 m** in the room.

**(3)** The devices for the introduction of fresh air for compensation in case of fire, will have a standardized useful free surface, related to the useful area of the devices for smoke evacuation that they protect, according to the Rules.

**(4)** Permanently open natural ventilation gaps, practiced in the lower third of the exterior walls, add up to the free surface required for air compensation in case of fire.

**(5)** Air intake holes are in all cases in the lower third of the walls of the room/space and are distributed alternately (between them), distributing as evenly as possible in the protected space, having their upper edge no more than **1 m** from the front of flooring in the case of rooms/spaces with a maximum free height of **3 m**.

**Article 8.2.2. (1)** Smoke evacuation devices in the event of fire shall have a normal free aerodynamic area relative to the surface of the room they protect, in accordance with the provisions of the legislation.

**(2)** Permanently open natural ventilation gaps in the roof or in the upper third of the external walls shall be added to the free surface required for smoke evacuations.

**(3)** The devices for protecting the gaps for intake and exhaust (valves, panels, hatches, etc.) must be (in the standby position), fireproof for air intake and fireproof for smoke exhaust, with the resistance to fire at least equal to that of the channel in which they are mounted, but at least the fire performance provided for in **Art. 8.1.10 paragraph 11**. For devices provided in the roof or in external walls, these conditions are not mandatory.

**Article 8.2.3.** Smoke evacuation devices and hot gases shall meet the following requirements:

- a)** reliability class **Re 300** (300 cycles) and devices with dual operation (also used for normal ventilation) shall be subjected to **10,000** ventilation opening cycles;
- b)** the snow load classification is **SL 250 (25 daN/m<sup>2</sup>)** for areas with an altitude below **400 m**, **SL 500 (50 daN/m<sup>2</sup>)** for heights between **400 m** and **800 m** and the obligation to associate with devices that prevent the accumulation of snow; at altitudes above **800 m**, the slope of the roof and devices shall be **> 45°**;
- c)** class **T (-0,5)** for ambient temperature (-0.5 °C);
- d)** class **B<sub>300</sub>30 (300°C for 30 minutes)** for exposure to heat.

**Article 8.2.4. (1)** Smoke exhaust hatches provided in smoke exhaust ducts that open automatically to extract smoke must have a fire resistance of at least class **B<sub>300</sub> 30**. The smoke exhaust duct in which the smoke exhaust hatch is installed must be at least **EI 30** fire resistant. The fire resistance class of smoke exhaust hatches must be equal to or higher than that of the smoke exhaust duct in which they are installed.

**(2)** Movable meshes can be used in smoke and hot gas exhaust systems for a single room and/or a single smoke tank.

(3) Smoke tanks must meet the requirements set out in Art 8.1.3. and Art. 8.1.13.

(4) A smoke exhaust hatch is provided at a maximum of 200 m<sup>2</sup> of the floor surface, according to SR CEN/TR 12101-4.

(5) The total area of the building and/or the smoke zones connected to a smoke and hot gas exhaust manifold on each floor must not exceed the surface of the maximum smoke zone allowed in accordance with Art. 8.1.13.

**Article 8.2.5.** When the main room equipped with a smoke and hot gas exhaust system contains one or more rooms with an area of less than 36 m<sup>2</sup>, the installation of smoke and hot gas exhaust systems in the smaller rooms is optional, the smaller rooms having to be provided with the same active protection systems as the main room. In this case, the amount of smoke must be calculated on the basis of the area summed up with the inner chambers, according to the percentage based on the density of heat load contained therein.

**Article 8.2.6. (1)** The aerodynamic free area of the air inlets is the total unobstructed cross-sectional area (geometric free area), measured in the plane where the area is minimum and at right angles to the direction of the air/smoke flow, multiplied by the flow coefficient.

(2) In the absence of standardized tests, the flow coefficient for the air inlets is chosen according to the provisions of Table 119, in accordance with SR EN 12101-2.

**Table119: Flow coefficient values for air inlets**

Type of opening	Opening angle (degree) <sup>(1)</sup>	Flow coefficient
Free opening (gap, inlet port, etc.)	-	0.7
The opening angle of the protection elements of the air inlets	≥ 90°	0.7
Grids/blinds protecting the air inlets	90°	0.65
The opening angle of the protection elements of the air inlets	≥ 60°	0.5
	≥ 45°	0.4
	≥ 30°	0.3

Note: (1) the opening angle with respect to the vertical axis, with a tolerance of  $\pm 5^0$ .

(3) In the absence of standardized tests, the flow coefficient for mobile smoke exhaust devices/holes/mesh is chosen according to the provisions of Table 120.

**Table120: The values of the flow coefficient for the mobile smoke exhaust devices/ inlets/ meshes**

Type of opening	Opening angle (degree) <sup>(1)</sup>	Flow coefficient
Free opening (gap, inlet port, etc.)	-	0.65
Grids/shutters protecting the smoke exhaust vents	90°	0.5
Opening angle of mobile devices/mesh	≥ 90°	0.65
	≥ 60°	0.5 0.35 <sup>(2)</sup>
	≥ 45°	0.4 0.3 <sup>(2)</sup>
	≥ 30°	0.3 0.15 <sup>(2)</sup>

Notes: <sup>(1)</sup> the opening angle with respect to the vertical axis, with a tolerance of  $\pm 5^0$ .

<sup>(2)</sup> when opening inwards

### 8.3. Smoke evacuation by mechanical ventilation

**Article 8.3.1. (1)** The evacuation of smoke and hot gases by mechanical ventilation shall be ensured by mechanical smoke evacuation and the mechanical introduction of air so that there is controlled air circulation and a controlled discharge of smoke in the protected space. Where smoke is discharged by mechanical ventilation and the introduction of compensation air is natural, the exhaust system for smoke and hot gases may be considered as mixed, repeating a particular case of the smoke exhaust system and hot gases by mechanical ventilation.

**(2)** The natural introduction of air is carried out in accordance with the provisions laid down and mechanically by insertion pits connected via channels (cheques) to an introduction fan.

**(3)** Smoke evacuation is carried out in accordance with the standard provisions, and the mechanical evacuation is ensured by ducts connected to the exhaust fan.

**(4)** The air speed at the insertion apertures shall not exceed 5 m/s and mechanical air inserts shall ensure a minimum 75 % from the exhaust volume flow rate (with a tolerance of plus or minus 10 %).

**(5)** Smoke vents must be protected with fire-tight dampers on inlets and fire-resistant dampers on outlets in the standby position. It is not compulsory to provide for drains where the drains or outlets are on a single storey.

**(6)** The ratio of the long side to the short side of an inlet or outlet shall not exceed 2.

**(7)** The valve actuators shall be carried out in accordance with the provisions laid down and in the event of fire to ensure the automatic operation of smoke discharge fans.

**(8)** When exceptionally provided, the chambers for smoke and fibre-gas exhaust fans shall be separated from other buildings, rooms and technical installations in accordance with **Article 2.4.14.3 paragraph 3**. It is not necessary to provide rooms as specified above if the smoke hatches or outlets are installed outside the building.

**Article 8.3.2.** The building's normal ventilation or air-conditioning system may also be used to exhaust smoke and hot gases produced in the event of a fire if it meets the standard conditions for smoke exhaust.

### 8.4. Smoke exhaust and air intake ducts, niches, ventilators

**Article 8.4.1. (1)** Regardless of the system adopted for smoke evacuation in the event of a fire, the smoke exhaust and air intake ducts shall be separate.

**(2)** The cross-section of the pipes shall be at least equal to that of the outlets to which they are connected and the ratio of the cross-sectional sides shall not exceed 2.

**3.** Inside rooms which are provided with smoke and hot gas exhaust systems, smoke exhaust and air inlet ducts shall be made of materials of reaction to fire class **A1** or **A2-s2d0** and performance criteria **E<sub>600</sub> 30 (ve and/or ho)S<sub>single</sub>** (or **E<sub>300</sub> 30 (ve and/or ho) S<sub>single</sub>** inside rooms equipped with an automatic sprinkler system), and the construction elements to which the piping is attached shall have a fire resistance at least equal to that of the piping, according to the criteria applicable to them.

**(4)** When passing through rooms for other purposes, smoke exhaust and air intake ducts shall be of reaction to fire class **A1** or **A2-s2d0** and fire resistant to a minimum of **EI 60 (ve and/or ho) S<sub>multi</sub>**.

**(5)** In tall buildings, very tall buildings, buildings with crowded, mixed, underground, hospital, etc. rooms or other types of buildings, when passing through rooms for other purposes as well as on horizontal circulation routes, the smoke exhaust and air intake ducts shall be of reaction to fire class **A1** or **A2-s2d0** and fire resistant to a minimum:

- **EI90(ve and/or ho)S<sub>multi</sub>** (**E<sub>300</sub>90<sub>ve</sub>** or **hoS<sub>single</sub>** if they do not intersect fireproof walls or floors) when the building has lifts for transporting people with wheelchairs or people with disabilities that can also be used for their assisted evacuation in case

of fire or lifts for transporting patients with wheelchairs, with the stretcher or cart or of disabled persons that can also be used for their assisted evacuation in case of fire.

- **EI120**(<sub>ve</sub> and/or <sub>ho</sub>)**S<sub>multi</sub>** (**E<sub>300</sub>120<sub>ve</sub>** sau **hoS<sub>single</sub>** if they do not intersect fireproof walls or floors) when the building has lifts for transporting people with wheelchairs or people with disabilities that can also be used for their assisted evacuation in case of fire or lifts for transporting patients with wheelchairs, with the stretcher or cart of disabled persons that can also be used for their assisted evacuation in case of fire, in tall and very tall buildings;

- **Ei120**(<sub>ve</sub> and/or <sub>ho</sub>)**S<sub>multi</sub>** (**E<sub>300</sub>120<sub>ve</sub>** sau **hoS<sub>single</sub>** if they do not intersect fireproof walls or floors) when lifts for intervention are provided in the building.

In these cases, if they are connected to vertical pipes at the height of the construction, they as well as the shutters provided for entering the collector channels will not have a fire resistance time lower than that of the other pipes that connect to them.

(6) Vertical smoke exhaust ducts (except collectors) must withstand a fire of at least **EI60<sub>ve</sub>S<sub>multi</sub>** (or **E<sub>300</sub>60<sub>ve</sub>S<sub>single</sub>** inside rooms that are equipped with automatic sprinkler extinguishing system). When the smoke is extracted from the exhaust ways (corridors, hallways, halls, foyers, etc.) or from rooms directly outside, it is allowed to use smoke exhaust ducts with a resistance of at least **EI30<sub>ve</sub>S<sub>multi</sub>** (or **E<sub>300</sub>30<sub>ve</sub>S<sub>single</sub>** inside the rooms that are equipped with an automatic sprinkler extinguishing system).

(7) The smoke exhaust and air intake ducts can be connected to individual vertical niches or to vertical collector niches (shunt), with pipes according to the normative provisions. The vertical niches through which the collector ducts of the smoke and hot gas exhaust system in case of fire crosses other levels of the construction will fulfil the conditions stipulated in Art. 2.4.11.2. and the specific requirements of each destination according to the regulations.

(8) The exhaust systems of the above ground and air inlet levels of the construction shall be independent of those of the underground levels.

(9) Vertical collecting ducts, with the area sized to accommodate the corresponding discharge and inlet requirements of more than one room or space, shall have the performance specified in Table 118. The niches will be made by fire reaction class A1, A2s1d0 walls with a minimum fire resistance of EI 180 and the hatches and access doors in the walls of the vertical niches must be made of **A1, A2s1d0** materials with EI 90 fire resistance. When passing through other levels of the building, the smoke exhaust openings protected by shutters shall be at least **EI60<sub>multi(f--o)</sub>** resistance at the smoke exhaust openings and fireproof at least **E<sub>600</sub>60<sub>single(f--o)</sub>** at the air intake openings, normally closed in standby position.

**Article 8.4.2. (1)** Smoke discharge fans in the event of a fire by mechanical ventilation shall be fire resistant class **F<sub>400</sub>120**.

(2) In buildings equipped with automatic water fire-extinguishing systems, smoke discharge fans may be provided in the event of a fire class **F<sub>200</sub>120**.

(3) The connection between the smoke fan in the event of fire and the smoke outlet/pipe, shall be made of products of the class reaction to fire **A1** or **A2-s2d0**.

(4) Fans for introducing fresh air in the event of fire by mechanical ventilation shall be installed outside the building in such a way that the components on which they are freely arranged have a minimum fire resistance **REI/EI60 (A1 or A2-s1, d0)** or be screened to a minimum **3 m** to the tyre of the construction with minimum fire resistant elements **REI/EI60 (A1 or A2-s1, d0)** or placed inside the building in rooms provided with walls **REI/EI60 (A1 or A2-s1, d0)**, floors **REI60 (A1 or A2-s1, d0)** and doors **EI60-C**self-closing, in buildings with **III, IV** and **V** fire stability.

(5) Fans for introducing fresh air in the event of fire by mechanical ventilation shall be installed outside the building in such a way that the components on which they are freely arranged have a minimum fire resistance **REI/EI120 (A1 or A2-s1, d0)** or be screened to a minimum **3 m** to the tyre of the construction with minimum fire resistant elements **REI/EI120 (A1 or A2-s1, d0)** or placed inside the building in rooms provided with walls **REI/EI120 (A1 or A2-s1, d0)**, floors

**REI120 (A1 or A2-s1, d0)** and doors **EI120-C, with** self-closing, in buildings with **I** and **II** fire stability.

**(6)** The fans for introducing fresh air in case of fire by mechanical draft will be fire resistant class F400 120 when installed in the serviced space. In buildings equipped with automatic water fire-extinguishing systems, class F<sub>200</sub>120 fresh air inlet fans may be provided for installation in the space served.

**Article 8.4.3.** Air injection and smoke evacuation fans in the event of fire shall be supplied with mandatory electrical power from two independent sources.

**Article 8.4.4.** The operating and non-functioning status of smoke and hot gas exhaust ventilators in the event of a fire will be signalled in places where stand-by duty is provided and at the emergency services (where provided).

**Article 8.4.5.** The vertical chimneys for the evacuation of smoke in case of fire will have the outer ends through which the smoke is evacuated, located at the top of the constructions or portions of above-ground buildings and arranged at distances of at least 1.5 m from combustible elements.

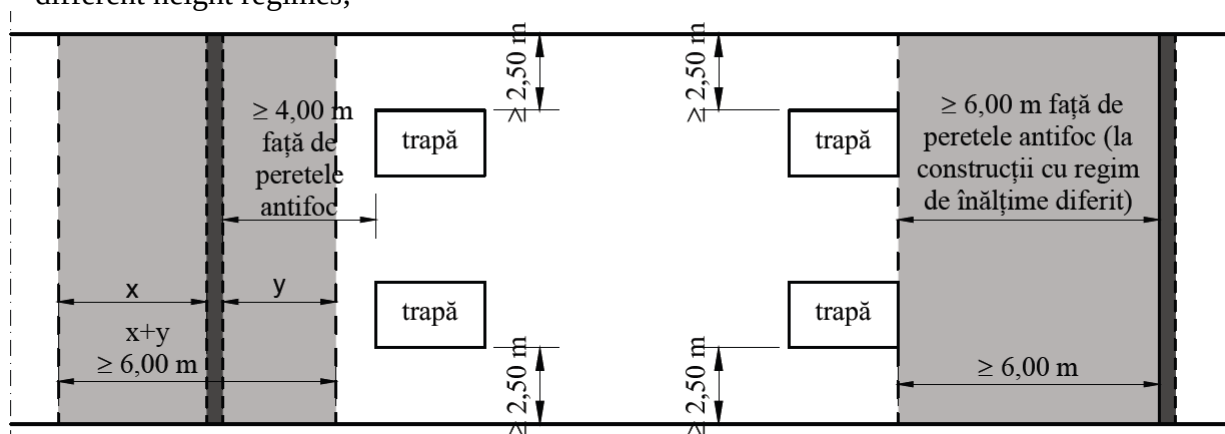
**Article 8.4.6. (1)** Vertical chimneys for the evacuation of smoke in case of fire will have the outer ends through which the smoke is evacuated, located at the top of the respective buildings or portions of above-ground buildings. The construction elements around the smoke exhaust openings (vertical smoke exhaust chimneys and smoke exhaust hatches) must be protected/made with/made of construction products with fire reaction class A1 or A2-s1d0 at a distance of little bit:

- a) **2 m** laterally (all around) when installed in the roof;
- b) **1 m** laterally (all around) and at least **2 m** above, when placed in external walls.

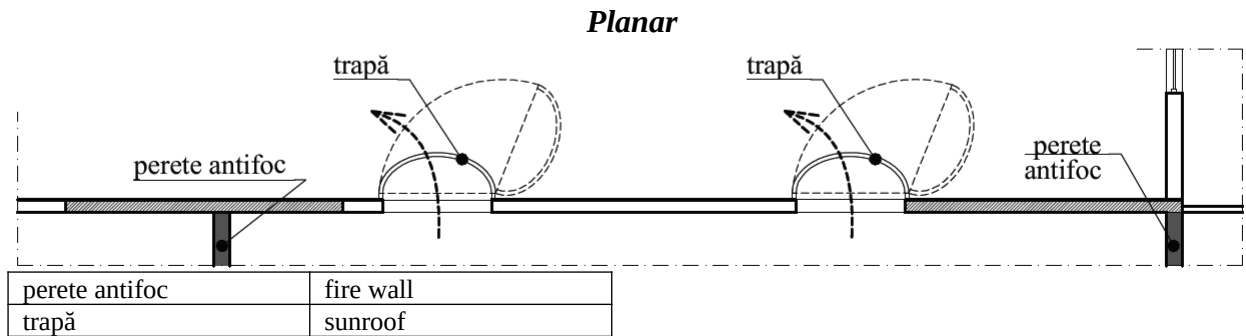
**(2)** Minimum distances between fresh air sockets and the outer ends of smoke evacuation guides shall be ensured **8 m** (measured horizontally). The ends of smoke discharge chimneys shall be positioned in such a way that, as far as possible, the dominant wind does not lead the smoke to the air sockets.

**(3)** The distance from the edge of the smoke outlets in the roof of buildings shall be (as shown in Figure 80) at least:

- a) **4 m** from fire resistant walls separating fire compartments when the two fire compartments have the same height regime;
- b) **2.5 m** to external walls;
- c) **6 m** from external walls with glazed surfaces without fire resistance of a higher portion of the building/adjacent building/set back level, if this is not constituted as a separate fire compartment (in the case of combining buildings) or from fire-resistant walls fire that separates fire compartments under conditions where the two fire compartments have different height regimes;



> 4,00 m față de peretele antifoc	> 4.00 m against the fire wall
trapă	sunroof
> 6,00 m față de peretele antifoc (la construcții cu regim	> 6.00 m from the fire wall (in buildings of different



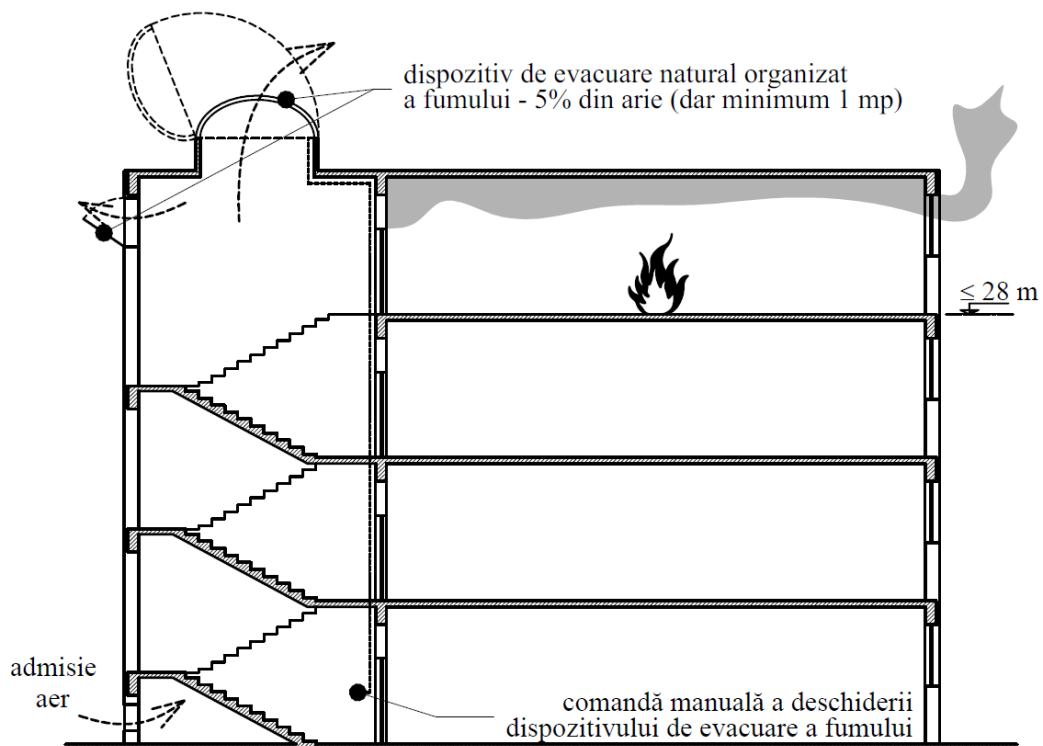
**Section**

**Figure 80 - Placing smoke and hot gas vents on the roof/terrace of buildings**

## 8.5. Enclosed stairwells and enclosed horizontal common circulation

**Article 8.5.1. (1)** Enclosed above-ground staircases which ensure the evacuation of users and have no direct windows to the outside, shall be provided with a smoke evacuation system in the event of fire, by natural-organised draught, or shall be overpressurised.

**(2)** The evacuation of smoke and hot gases by natural-organised draught from enclosed stairwells is achieved by the automatic opening in case of fire of the smoke exhaust device (located in the wall at the top level of the stairwell or in the roof of the stairwell) and of the air inlet provided at its lower part (at the level of the access way from outside). Automatic opening devices shall also have manual actuations (Figure 81).



dispozitiv de evacuare natural organizat a fumului - 5% din arie (dar minimum 1 mp)	organised natural smoke evacuation device - 5% of the area (but minimum 1 m <sup>2</sup> )
admisie aer	air intake
comandă manuală a deschiderii dispozitivului de evacuare a fumului	manual control of the opening of the smoke exhaust device

**Figure 81 - Smoke evacuation from closed above-ground stairwells ensured by natural draft (the principle does not apply to closed stairwells provided with overpressure)**

**Article 8.5.2. (1)** The aerodynamic free area of the exhaust device for smoke and hot gases by natural - organised draught shall be at least 5% of the largest area of one level of an enclosed stairwell, but at least 1 m<sup>2</sup>. The free area of the device for the introduction of fresh air by natural - organised draught must represent at least 75% of the useful free area of the smoke exhaust hatch. The opening of the smoke outlet (hatch) and the air inlet shall be capable of being controlled automatically (by the fire detection and fire alarm control panel or other devices if there is no fire detection and fire alarm system) and manually from the access way outside the staircase and from the private fire brigade (when provided). In case the air intake is via the access door to the stairwell directly from the outside, it will be opened automatically and manually.

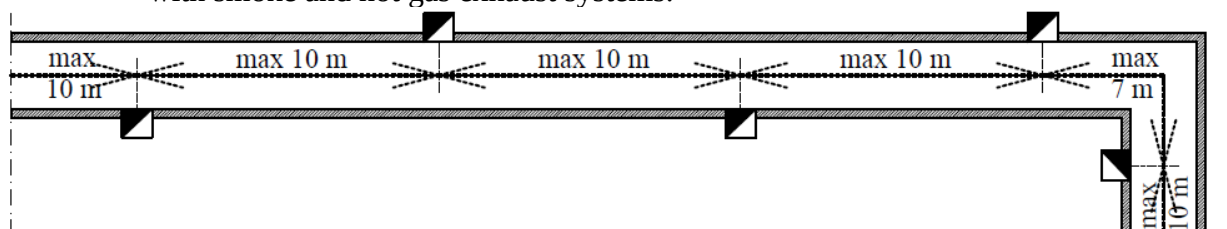
**Article 8.5.3. (1)** Air intake in enclosed above-ground stairwells can be provided naturally through air inlets or mechanically (with air intake fan). In the event of mechanical introduction of air by pressurization, the actuation will be automatic by means of a fire detection, signalling and alarm system or other devices if there is no fire detection, signalling and alarm system and pressure compensation devices will be provided by gravity grids (in the building envelope, according to the profile standard) or by pressure transducers.

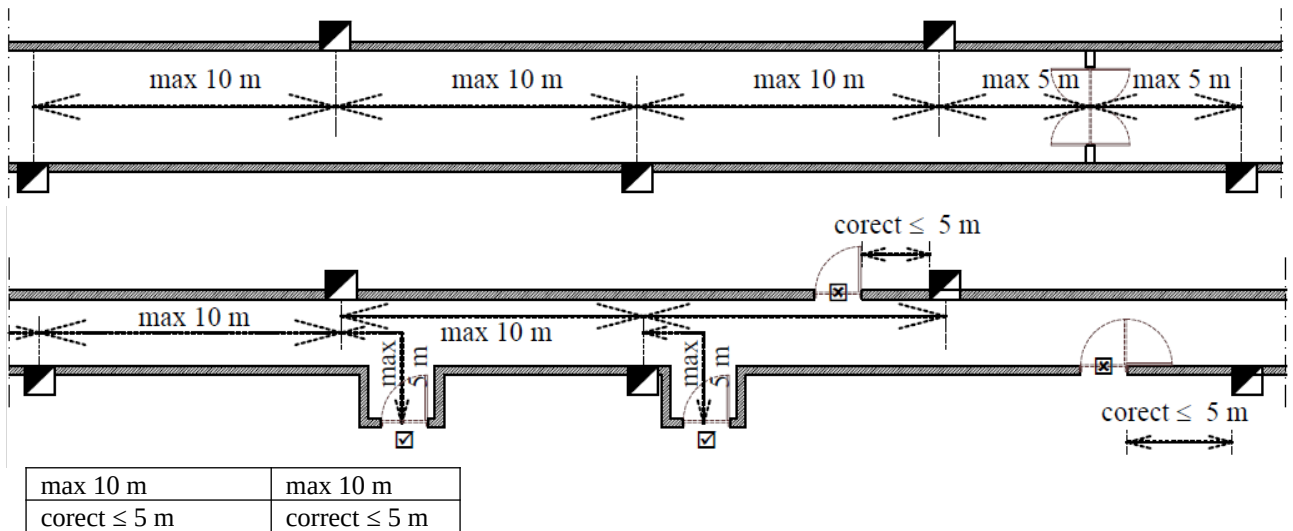
**(2)** The escape of smoke and hot gases in the event of fire from enclosed stairwells is not permitted by mechanical ventilation.

**(3)** The evacuation of smoke and hot gases in the event of fire from enclosed underground stairway houses ensuring the evacuation of users may be carried out by natural and organised draught, in accordance with the standard provisions.

**Article 8.5.4. (1)** The evacuation of smoke and hot gases in the event of fire by organised natural draught of closed horizontal common circulations in construction shall comply with the following conditions:

- a)** air inlets and smoke outlets shall be alternated, at horizontal distances measured at the axes of the respective circulations, which shall not exceed **10 m** in a straight line, or **7 m** braked line (Figure 82);
- b)** doors of user-accessible rooms located on an escape route that is not between an air inlet and a smoke outlet should be no more than **5 m** from either;
- c)** the inlets and smoke vents shall have areas of not less than **0,1 m<sup>2</sup>** for each horizontal common circulation exhaust passage (flow) unit in the area to be provided with smoke and hot gas exhaust systems.



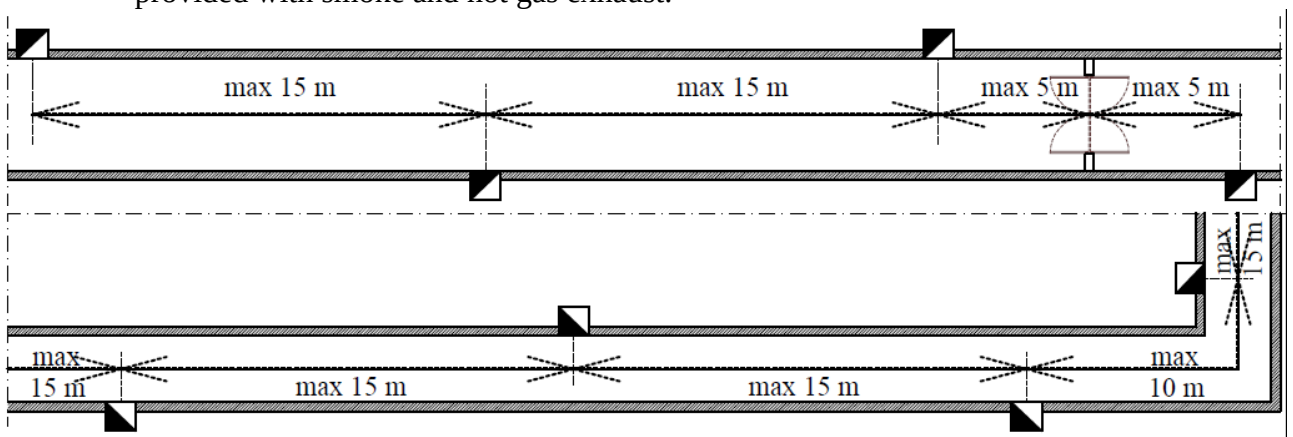


**Figure 82 - Exhaust of smoke and hot gases in case of fire from horizontal common circulations by natural-organised draught**

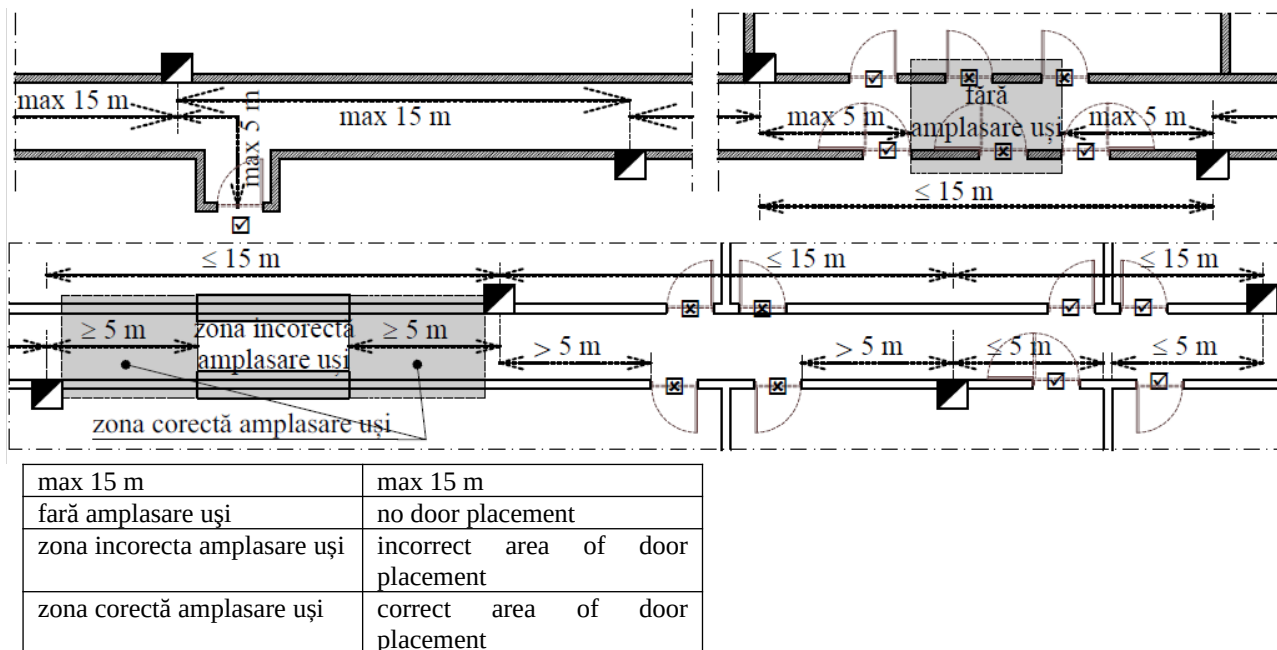
(2) The gaps in the perimeter enclosing walls of the construction may constitute air inlets or smoke outlets if they comply with the conditions of arrangement, operation and sizing laid down in the standard and in the specialist technical regulations.

**Article 8.5.5.** The exhaust of smoke and hot gases in the event of fire by mechanical ventilation of closed horizontal common circulation in buildings shall comply with the following conditions (Figure 83):

- air inlets and smoke outlets shall be alternated, at horizontal distances measured at the axes of the respective circulations, not exceeding **15 m** in a straight line, and **10 m** in a braked line;
- doors in rooms accessible to users, situated on a route of escape which is not between an air insertion mouth and a smoke outlet, it is advisable to be at most **5 m** by any of them;
- the portions of the horizontal common circulation between an air inlet and a smoke exhaust outlet shall be provided with an extraction flow (at the inlet) of at least **0,5 m<sup>3</sup>/s** for each horizontal common circulation exhaust passage unit (flow) in the area to be provided with smoke and hot gas exhaust.







**Figure 83 - Exhausting smoke and hot gases in case of fire from horizontal common circulation by mechanical ventilation**

**Article 8.5.6. (1)** The protected openings are overpressured with respect to the adjacent rooms with which they communicate, according to the provisions of the normative and specialized technical regulations.

**(2)** The common horizontal circulations that do not have direct windows to the outside through which to evacuate the smoke (considering roofs placed at a maximum depth of 30 m), are provided with a system for evacuating the smoke and hot gases in case of fire by natural draft-organized or through mechanical ventilation or are overpressured compared to the adjacent rooms with which they communicate, according to the provisions of the norm and specialized technical regulations.

**Article 8.5.7. (1)** The overpressure of horizontal common functional circulations shall be such that the pressure on the doors does not exceed **80 Pa**.

**(2)** Pressurization of protected horizontal clearances, buffer rooms and protected stairwells must be carried out so that the pressure on the doors is in accordance with **SR EN 12101-13** -Smoke and heat control systems. Part 13: Pressure differential systems (PDS). Design and calculation methods, installation, acceptance testing, routine testing and maintenance, and **SR EN 12101-6** – Smoke and heat control systems. Part 6: Specification for pressure differential systems. Kits.

**Article 8.5.8.** In high-rise or very high-rise buildings, the horizontal common circulation shall be provided to exhaust smoke and hot gases in accordance with the provisions of these Rules. Closed stairwells and buffer rooms are overpressurised, the design and calculation of the system is done alternatively and based on standards **SR EN 12101-13** -Smoke and heat control systems. Part 13: Pressure differential systems (PDS). Design and calculation methods, installation, acceptance testing, routine testing and maintenance, and **SR EN 12101-6** –Smoke and heat control systems. Part 6: Specification for pressure differential systems. Kits

**Article 8.5.9. (1)** For enclosed stairwells, protected decks, escape tunnels and overpressurised buffer spaces, the design and calculation of the system shall be carried out alternatively and on the basis of standards **SR EN 12101-13** -Smoke and heat control systems. Part 13: Pressure differential systems (PDS). Design and calculation methods, installation, acceptance testing, routine testing and maintenance, and **SR EN 12101-6** –Smoke and heat control systems. Part 6: Specification for pressure differential systems. Kits

(2) The air velocity shall be at least 1 m/s at access doors to the fire level and stairway access doors from the outside of the building, with all other doors closed.

(3) Protected clearances, evacuation tunnels and buffer rooms are pressurized through a pipe separate from the one for the stairwell. The pressure in the stairwell must be gradual, at least 5 Pa higher than the pressure in the pressurized spaces with which it communicates directly. In the other pressurized spaces with which they communicate directly, the gradient must be maintained at least 5 Pa more than the pressure in the previous spaces on the circuit of the escape path to the stairwell.

## 8.6. Atriums

**Article 8.6.1.** The evacuation of smoke and hot gases in case of fire from closed atriums must be ensured as follows:

**a)** when the density of the heat load ( $q$ ) is less than **105 MJ/m<sup>2</sup>** smoke evacuation is carried out through a smoke and hot gas evacuation system in the event of fire through natural-organized draft with automatic opening devices, which ensure a free surface of at least 1% of the area of the highest level of the atrium delimited by the walls (without taking into account the access to the atrium), but at least 2 m<sup>2</sup> or through a smoke and hot gas exhaust system in case of fire through mechanical ventilation, properly designed and dimensioned.

**b)** when the density of the heat load ( $q$ ) is greater than **105 MJ/m<sup>2</sup>** smoke evacuation is carried out through a smoke and hot gas evacuation system in the event of fire through natural-organized draft with automatic opening devices that ensure a free surface of at least **5%** of the area of the highest level of the atrium delimited by walls (without to take into account the access to the atrium) or through the exhaust system of smoke and hot gases in case of fire through mechanical ventilation, appropriately designed and dimensioned.

**c)** When spaces with health, accommodation, education, trade functions are provided adjacent to the atrium, regardless of the thermal load, the atriums are provided with smoke and hot gas exhaust systems in case of fire through natural draft-organized with automatic opening devices that ensure a free surface of at least **5%** of the area of the highest level of the atrium delimited by the walls (not taking into account the access to the atrium) but at least **2 m<sup>2</sup>** or through a smoke and hot gas exhaust system in case of fire through mechanical ventilation, properly designed and dimensioned.

**Article 8.6.2. (1)** Air intakes are provided at the bottom of the atriums.

(2) In the case of natural-organised draught smoke evacuation, the useful free aerodynamic area of the air inlets shall provide a free area of not less than **75%** of the free area of the smoke evacuation devices and the mechanical introduction shall not exceed **5 m/s** per grille.

(3) In the case of smoke evacuation by mechanical ventilation the mechanical air inlets must provide at least **75%** of the evacuated volumetric flow rate (with a tolerance of plus or minus **10%**) and the air velocity at the inlets shall not exceed **5 m/s** per grille.

(4) The automatic actuation of smoke exhaust and air intake devices shall be controlled by a fire detection, signalling and alerting system.

(5) Automatic actuation of smoke exhaust and air intake devices will be coupled with manual controls located at the outside accesses to the atrium and from the emergency service (where provided).

## 8.7. Simplified calculation method for smoke and hot gas evacuation in case of fire

**Article 8.7.1. (1)** In order to limit the propagation of fires, the building shall be provided with a smoke and hot gas evacuation system, made in accordance with the provisions of the

standard, with smoke tanks made in accordance with Art. 8.1.12. and Art. 8.1.13. and screens or perimeter walls (ensuring at least the same fire performance as the screens), using the simplified calculation method for the evacuation of smoke and hot gases in case of fire.

**Article 8.7.2.** The smoke and hot gas exhaust system consists of air inlets in the lower part (lower third of the walls) of the protected space, continuous fire-resistant screens with a minimum fire resistance of DH 30, or structural elements with a minimum fire resistance of 30 minutes, lowered below the roof or the upper floor of the space in question by at least 50 cm, and smoke and hot gas outlets in the upper third of the walls or in the roof.

**Article 8.7.3. (1)** The arrangement of the lowered screens under the roof or under the upper floor of the protected space in the simplified natural-organised draught exhaust calculation system shall be based on the heat load density of the space as specified in Table 121.

**(2)** Continuous screens shall be fixed to the structural elements of the building in the area of potential fire risk

**Table 121: Arrangement of continuous screens in a natural-organised draught smoke and hot gas exhaust system**

<i>Heat load density 'q' (MJ/m<sup>2</sup>)</i>	<i>The ratio of the sum of the free areas of the smoke vents to the area of the enclosure</i>
$q \leq 420 \text{ MJ/m}^2$	<b>1 : 100</b>
$420 \text{ MJ/m}^2 < q \leq 840 \text{ MJ/m}^2$	<b>1 : 100 to 1 : 80</b>
$840 \text{ MJ/m}^2 < q \leq 1680 \text{ MJ/m}^2$	<b>1 : 80 to 1 : 66,(6)</b>
$1680 \text{ MJ/m}^2 < q \leq 4200 \text{ MJ/m}^2$	<b>1 : 66,(6) to 1 : 40</b>
$q > 4200 \text{ MJ/m}^2$	<b>1 : 30</b>

Note:

- for intermediate values of heat load density calculation, the ratio is determined by linear interpolation

**Article 8.7.4. (1)** Smoke and hot gas vents in the event of fire shall be distributed as evenly as possible in the protected space and may be permanently open or closed (protected by devices with automatic opening in the event of fire and manually operated).

**(2)** Opening smoke and hot gas vents in case of fire can be done individually or in groups.

**(3)** Where there are smoke escape openings in the roof, in the top third of the roof rafters, referred to the maximum height of the roof rafters, or in the top third of the outer walls of the room (where the roof slope is less than 20°), these shall be added to the area required for the escape of smoke and hot gases produced in the event of fire.

**Article 8.7.5.** The natural-organised draught exhaust devices for smoke and hot gases specified in the standard must meet the requirements laid down in the standard and in the series of European standards SR EN 12101 as well as SR CEN/TR 12101-4 and SR CEN/TR 10101-5.

**Article 8.7.6.** When exhausting smoke and hot gases by mechanical ventilation, the following conditions shall be observed:

- a)** the screens shall be arranged in accordance with the provisions laid down for the exhaust system by natural and organised draught and shall be continuous, constructed and arranged to provide a cassette of the space under the roof or top floor;
- b)** the exhaust outlets are arranged in such a way as to ensure at least one outlet per maximum **200 m<sup>2</sup>**;

c) depending on the density of the thermal load ( $q$ ), the extraction flow of an outlet will be at least  $1 \text{ m}^3/\text{s}$  and a maximum of  $3 \text{ m}^3/\text{s}$  for  $100 \text{ m}^2$  delimited by screens, according to the provisions of Table 122:

**Table 122: Extraction flow of a smoke and hot gas outlet by mechanical ventilation**

Density of heat load ( $q$ ) in rooms ( $\text{MJ}/\text{m}^2$ )	Extraction rate of an outlet ( $\text{m}^3/\text{s}$ )
$q \leq 420 \text{ MJ}/\text{m}^2$	1
$420 \text{ MJ}/\text{m}^2 < q \leq 840 \text{ MJ}/\text{m}^2$	From 1 to 1.25
$840 \text{ MJ}/\text{m}^2 < q \leq 1680 \text{ MJ}/\text{m}^2$	From 1.25 to 1.5
$1680 \text{ MJ}/\text{m}^2 < q \leq 4200 \text{ MJ}/\text{m}^2$	From 1.5 to 2,5
$q > 4200 \text{ MJ}/\text{m}^2$	3

Note:

- for intermediate calculation values of heat load densities, the extraction rate shall be determined by linear interpolation or choose maximum value

d) a maximum of two smoke tanks delimited by screens may be connected to an exhaust fan and the fan flow rate may be reduced to the flow rate required by the largest connected smoke reservoir.

**Article 8.7.7. (1)** Air intakes may be natural or mechanical and shall be provided at the bottom in the lower third of the protected space (with their upper edge not more than  $1 \text{ m}$  above floor for rooms/spaces of maximum clear height  $3 \text{ m}$ ), it is recommended that they be located in areas opposite to escape ports or façades.

(2) It is not permissible for fuel elements to cross screens.

**Article 8.7.8. (1)** In spaces with full suspended ceilings, the screens delimiting the smoke tanks shall descend from the roof soffit and extend beyond the plane of the full suspended ceiling by at least  $50 \text{ cm}$ .

(2) The plenum fitted with automatic sprinkler fire-extinguishing systems, bounded by screens, the roof soffit and the full suspended ceiling shall constitute smoke tanks independent of those under the full suspended ceiling, which shall be fitted with smoke and hot gas exhaust systems independent of those under the full suspended ceilings and shall be sized accordingly. The passage of smoke and hot gases from the smoke tank under the full suspended ceiling through the smoke tank in the plenum is not permitted except through fire-resistant ducts/tubes in accordance with the regulations.

**Article 8.7.9. (1)** In all cases, automatic operation of smoke and hot gas exhaust devices (hatches, hoods, grilles, etc.) will be doubled by manual operation.

(2) Similarly and concurrently with the actuation of the smoke and hot gas exhaust devices, the compensating air inlet devices shall be actuated as appropriate.

## CHAPTER 9

### **INTERVENTIONS IN EXISTING CONSTRUCTIONS CONSTITUTING A BUILDING FUND PRIOR TO THE DATE OF ENTRY INTO FORCE OF THE RULES**

**Article 9.1.** Interventions to existing constructions that are not extended, are carried out preserving the fire performance of the construction elements that are replaced in accordance with the regulations applicable at the time of their realization (in accordance with Annex 10 of the Rules), and the equipping with fire safety installations is carried out in accordance with the technical regulations in force.

**Article 9.2.** Extensions to existing buildings shall be carried out in accordance with the technical regulations specified in *Annex 10*. Fire safety equipment shall be installed in accordance with the technical regulations in force.

**Article 9.3.** The following measures may be provided for existing buildings:

- preservation of their intended use and therefore of the fire performance of the structural elements of the existing building in accordance with the requirements of *Annex 10 on existing buildings*; if the intended use changes, the building can be brought into compliance according to the general technical regulations for new buildings or measures to improve the fire safety requirements or alternative protection (passive, active or combinations thereof) aimed at improving the requirements that cannot be met are provided on the basis of technical expertise on the basic fire safety requirement (building and/or installations). Even if there is no change of destination, the building may also comply with the requirements of the regulations in force for new constructions if the beneficiary so wishes.
- maintenance of the degree of resistance foreseen in *Annex 10* on existing buildings and the other provisions applicable to them, if there is no change of destination.
- only modifications to the non-structural elements of the building which will have the fire performance specific to the provisions of the *Annex 10* on existing constructions;
- fire compliance of the building shall be in accordance with the requirements of *Annex 10* on existing buildings, unless the use changes.

**Article 9.4.** For existing buildings (with the exception of extensions) measures to improve the fire safety requirement may be provided for, such as:

- use of construction materials and products the minimum reaction to fire class **C-s3, d1**, but as a minimum in accordance with the provisions laid down;
- use of building elements, materials and products with fire-resistance performance greater than the provisions laid down;
- reduction of heat load density in all existing building spaces;
- equipping the building with fire safety installations in addition to those provided for in the technical regulations in force;
- the enclosure of open interior staircases in closed stairwells and the provision of systems for the evacuation of smoke and hot gases in case of fire;
- provision of systems for the evacuation of smoke and hot gases in the event of fire of common horizontal exhaust circulations with lengths longer than **30 m** in the whole of the building;
- equipping the building with fire detection, signalling and alarm facilities and, where the deployed surface area is larger than **7,000 MP** or building has more than **5** levels above ground and where people stay at night; with the exception of residential buildings, it will also have a voice alarm system;
- fire-fighting equipment with sprinklers where the floor area exceeds **7,000** square metres or the building has more than **5** storeys above ground, except for residential buildings, if this is not required by specific regulations;
- equipping the construction with dry columns in addition to the requirements of the specific regulation;
- equipping the construction with lifts for evacuating disabled persons or for intervention, as the case may be, complying with the regulatory provisions;

- the provision of residual current devices (**RCD**) in accordance with the technical regulations in force or in addition to those provided according to the specifications of the standard "Standard for the design, execution and operation of electrical installations related to buildings", indicative **I7**;
- the provision of arc fault protection devices (by automatic disconnection when an electric arc fault occurs - **AFDD**) in accordance with the technical regulations in force or in addition to those provided for in the technical regulations in force, in accordance with the recommendations of SR EN 62606 and SR HD 60364-4-42/A1 as well as the specifications of the profile standard "Standard for the design, execution and operation of electrical installations related to buildings", indicative **I7**;
- the provision of a lightning protection system (**LPS**) for a construction and the choice of the level of lightning protection through external installation and/or internal installation of the lightning protection system (**LPS**) in accordance with the technical regulations in force or in addition to those provided in the technical regulations in force;
- provision of overvoltage and overcurrent protection devices (**OPD**) according to the recommendations of SR EN 61643-11, SR IEC/TR 62066, SR 60364-5-534, SR IEC 60364-4-44, etc.

## ANNEXES

### ANNEX 1 – LOCATION OF BUILDINGS

**(1)** *The standard conditions for limiting the possibilities of fire propagation between buildings and fire compartments are mandatory and are achieved by locating them at the minimum safe distances set out in **Table 4: Minimum safety distances between structures or above-ground fire compartments (civil, production and/or storage) or delimited by fire resistant bulkheads separating fire compartments (fire bulkheads) and, where applicable, fire resisting floors separating fire compartments (fire floors), applying the provisions laid down in Chapter II, Section III/2.3. - ‘Fire propagation limitation’/2.3.2. - ‘Fire-resistant elements for the separation of fire compartments and the protection of functional pass-through gaps’** in the legislation.*

**(2)** *For existing constructions, the safety distances set out in Annex 10 on **Table 145: Safety distances to existing constructions** or be bounded by fire resisting walls separating fire compartments (fire walls) and, where appropriate, fire resisting floor boards separating fire compartments (fire boards), the provisions laid down in CHAPTER 2/GENERAL PERFORMANCE CONDITIONS FOR EXISTING BUILDINGS/ A.10 shall apply. 2.2. BUILDING LOCATION AND FIREWALL COMPLIANCE/ Location.*

**(3)** *Buildings combined in a fire compartment shall be located in relation to other buildings or fire compartments at the minimum safety distances set out in **Table 4**, depending on the level of fire stability established in accordance with **Art. 2.2.1.1. paragraph 2**. The safety distances set out in **Annex 10 in Table 145** shall apply to existing buildings that have been joined together.*

**(4)** *Above-ground civil (public), production and/or storage buildings or mixed buildings shall be built in groups or clustered at unrestricted distances from each other, within the limits of specific fire compartments, with maximum permitted areas depending on the intended use, the most disadvantageous level of fire stability, the greatest fire risk and the number of standard levels (taking into account the sum of the actual built areas).*

**(5)** *Buildings intended for persons who cannot evacuate themselves (defined according to terminology), as well as for objects, equipment or apparatus of particular importance, higher*

and/or very high civil buildings or with crowded rooms, shall not be pooled with other constructions.

**(6)** The adjoining of tall and/or very tall above-ground civil buildings to other buildings or to each other is prohibited within the same fire compartment.

**(7)** Civil buildings of normal heights may be located independently or combined with other civil buildings of normal heights within the fire compartment areas for civil buildings permitted in the regulations (i.e. Annex 10 for existing buildings). Ordinary production and storage buildings may be located independently or combined with other production and/or storage buildings within the fire compartment areas permitted in the regulations (i.e. Annex 10 for existing buildings).

**(8)** Production and storage buildings shall not be merged with civil buildings and must be partitioned with fire walls or placed at safe distances (between production/storage buildings and civil buildings). Buildings with production and/or storage functions may be combined (with each other), ensuring the appropriate partitioning and protection measures for each function.

**(9)** The independent buildings as well as the groupings or mergers of constructions established according to **paragraph 4**, are located so as not to allow the propagation of fires for a specified period of time or, in case of collapse, not to affect the neighbouring objects, respecting the minimum safety distances or separating themselves from other constructions by fire walls. By summing up the built-up areas of the respective buildings (Ba), the maximum permissible values for the resulting fire compartment shall be respected, depending on the intended use and the most unfavourable level of fire stability provided, the highest fire risk and the standard number of levels. The fire compartment resulting from the merger of buildings will have the fire stability level determined by the building with the worst level, the highest fire risk and the standard number of levels.

**Example** (in accordance with **Figure 86**):

In the case of **new construction**, the resulting combination of **Building "A" + Building "B" + Building "C"** (with unimportant distances between them) shall comply:

- the most disadvantageous fire stability level for the resulting existing fire compartment (resulting in fire stability level **IV** of the merged compartment)

- maximum permissible area according to intended use for the resulting existing fire compartment (maximum permissible area according to intended use for the merged compartment with fire stability level **IV** according to Table 41: Conditions for correlating the built-up areas (Ba) of buildings and civil above-ground fire compartments with the fire stability level **or** Table 114: Condiții de corelare a ariilor construite (Ac) și a numărului de niveluri al construcțiilor și compartimentelor de incendiu supraterane de producție și/sau depozitare; pentru fiecare construcție cu funcțiuni mixte (civile-civile sau producție-depozitare/ producție-producție/ depozitare-depozitare) se aplică **Art. 7.1.1**; production and/or storage construction shall not be pooled with civil buildings)

- highest fire risk for the resulting existing fire compartment (according to subchapter **2.1.2. Fire risk (Art. 2.1.2.1. to Art. 2.1.2.6.) and Articles Art. 2.2.2.1., Art. 3.1.1.1., Art. 6.1.1.1., Art. 6.1.1.2., Art. 6.1.2.1., Art. 6.1.2.2. Article 7.1.3, etc.**; for buildings with mixed functions (civil-civil or production-warehousing/production-production/warehousing-warehousing) apply according to **Article 2.1.2.4. or Article 7.1.3.**)

- the standard number of levels, for the resulting existing fire compartment (number of levels according to intended use, for the merged compartment with fire stability level **IV**, according to **Table 42**: Conditions for correlation between destination, simultaneous maximum capacity and number of above-ground levels of civil buildings with fire stability level **III, IV or V or** Table 114: Conditions for the correlation of the built-up areas (Ba) and the number of levels of above-ground production and/or storage buildings and fire compartments)

In the case of existing buildings, the resulting combination of **Building "A" + Building "B" + Building "C"** shall comply:

- the most disadvantageous fire stability level for the resulting existing fire compartment (resulting in fire stability level **IV** of the merged compartment)
- maximum permissible area according to intended use for the resulting existing fire compartment (maximum permissible area according to intended use for the merged compartment with fire stability level **IV** according to Table 147: Permitted built-up areas for fire compartments of existing civil buildings (public) above ground) **or** Table 168: Built-up areas and number of permitted levels for existing buildings and fire compartments of existing production and/or storage buildings; for each building with mixed functions (civil-civil or production-warehousing/production-production/ warehousing-warehousing) shall apply in accordance with Articles **A.10. 7.1.3. and A.10. 7.1.4.**; production and/or warehousing construction shall not be pooled with civil buildings)
- the highest fire risk (i.e. the resulting fire hazard category) for the resulting existing fire compartment (according to Art. **A.10. 2.1.1., A.10. 2.1.2., A.10.2.1.3, A.10. 2.1.4., A.10. 2.1.5., A.10. 2.1.6., A.10. 2.1.1. (3), A.10. 2.2.8., A.10. 5.1.1., A.10. 7.1.3. and A.10. 7.1.4.** , etc.; for mixed-purpose buildings (civil-civil or production-warehousing/production-production-warehousing) shall apply in accordance with Articles **A.10. 2.1.1., A.10. 2.1.2. or A.10. 7.1.2., A.10. 7.1.3. and A.10. 7.1.4.** )
- the standard number of storeys for the resulting existing fire compartment (number of storeys according to use for the combined compartment with fire stability level **IV** according to Table 148 - Maximum permissible number of storeys above ground and capacity of existing civil buildings with fire stability levels III, IV and V **and/or** Table 168: Built-up areas and number of permitted levels for existing buildings and fire compartments of existing production and/or storage buildings)

Note: Exhaust lengths shall comply in accordance with the fire compartment's fire stability level **IV** for each of the uses of the buildings/constructions being merged (for both examples, i.e. new buildings being merged or existing buildings being merged).

Notes **Figure 87** (example for amalgamation of new civil buildings compared to other buildings/compartments arranged outside the property limit):

If the distance between the fire compartment formed by the resulting combination of **Building "A" + Building "B" + Building "C"** and other building(s)/other building(s)/other fire compartment(s) (e.g. from Building "E") does not comply with the prescribed safety distances, a fire wall (provided within the property boundary) shall be provided as prescribed (or a fire wall provided at the subject building/building, including provision of shutters, curtains, etc.). at the building/construction within the property boundary)

'**R**' is the regulatory safety distance (according to **Table 4:** Minimum safety distances between structures or above-ground fire compartments (civil, production and/or storage) or Table 145: Safety distances to existing constructions)

In all cases **Ba of merged fire compartment = Ba sum of pooled buildings**

## **ANNEX 2 – FIRE WALLS AND SECTORAL WALLS**

### **ANNEX 2.1 – FIRE WALLS AND PROTECTION OF FUNCTIONAL GAPS IN FIRE WALLS**

#### **Fire walls**

(10) Walls separating fire compartments shall have fire resistance determined according to the heat load density according to Art. **2.3.2.1.2.**, reaction to fire class **A1, A2s1d0.**

Walls separating fire compartments **must section off the full height of the building.**



## **Protection of functional gaps provided in fire walls**

**(11)** Doors provided for functional circulation or escape in walls separating fire compartments in civil buildings shall have fire resistance in accordance with Table 123.

**(12)** Doors provided for functional circulation or escape in walls separating fire compartments in production and/or storage buildings shall have fire resistance in accordance with Table 124. In production and/or storage buildings, escape routes for users may also be those passing through fire walls separating fire compartments:

- a) to compartments with a low fire risk, if they serve to evacuate users from adjacent production and/or storage areas;
- b) to compartments with a medium, high or very high fire risk, without volumetric explosion, if they serve to evacuate users of adjacent compartments and are not their only escape route, in which case the second escape route may also be through a space of medium, high or very high fire risk if the routes are distinct and separated from each other by fire resisting walls and the circulation openings therein are protected by fire resisting and smoke-tight enclosures in accordance with Table 124;
- c) rooms or spaces with a very high risk of fire and volumetric explosion, if they serve to evacuate users of production or storage spaces with the same risk of fire and do not constitute their only possibility of evacuation;

**(13)** Fire resistant doors, shutters and curtains protecting functional gaps in fire walls **EI-M180/REI180** (example) must be fire resistant for a minimum of 90 minutes as follows:

- a. Fire resistant doors (including their closing devices) shall be fire resistant to a minimum **EI<sub>2</sub> 90-C5S<sub>200</sub>**.
- b. Fire resistant shutters (including their closing devices) shall be fire resistant to a minimum of **EI<sub>2</sub> 90-C3**.
- c. Fire resistant curtains (fitted with sprinkler assemblies if they only meet the **E90** criterion) shall be fire resistant to a minimum of **EI 90** (fire tightness and thermal insulation 90 minutes).

\* are provided with self-closing "C" = self-closing/automatic closing class

Note: In all cases for fire walls faced with building façades with resistance of less than 3 hours (according to **Article 2.3.2.1.2.**), the gaps provided shall be protected by doors, fire resistant shutters (for a minimum of half of the fire resistance of the fire walls, but at least 1 hour for fire walls **EI-M 60/REI 60** or **EI-M 90/REI 90** and at least 90 min for the other fire walls provided for in **Article 2.3.2.1.2**, excluding fire walls **EI-M 240/REI 240** where they are protected by doors, shutters have fire-resistant curtains 120 min).

## **ANNEX 2.2 – FIRE WALLS AND FIRE-RESISTANT WALLS IN HALLS**

### **ANNEX 2.3 – FIRE COMPARTMENTATION WALLS INTENDED TO LIMIT THE SPREAD OF FIRE (FIRE PROTECTION WALLS LIMITING THE SPREAD WITHIN FIRE COMPARTMENTS)**

**(14)** In civil buildings, the following partitioning walls can be provided with the role of limiting the spread of fire, having at least the following performance levels:

- |                             |  |
|-----------------------------|--|
| - Level I (125 m ≥ h)       | - REI/EI 180 (A1 or A2-s1,d0), doors EI <sub>1</sub> 90-C5S <sub>200</sub> |
| - Level I (75 m ≤ h < 125m) | - REI/EI 180 (A1 or A2-s1,d0), doors EI <sub>2</sub> 90-C5S <sub>200</sub> |
| - Level I (45m ≤ h < 75m)   | - REI/EI 120 (A1 or A2-s1,d0), doors EI <sub>1</sub> 60-C5S <sub>200</sub> |
| - Level I (28m ≤ h < 45m)   | - REI/EI 120 (A1 or A2-s1,d0), doors EI <sub>2</sub> 60-C5S <sub>200</sub> |
| - Level I (h < 28m)         | - REI/EI 120 (A1 or A2-s1,d0), doors EI <sub>2</sub> 60-C5S <sub>200</sub> |
| - Level II                  | - REI/EI 90 (A1 or A2-s1,d0), doors EI <sub>1</sub> 45-C5S <sub>200</sub>  |
| - Level II (+)              | - REI/EI 90 (A1 or A2-s1,d0), doors EI <sub>2</sub> 45-C5S <sub>200</sub>  |
| - Level III                 | - REI/EI 60 (A1 or A2-s1,d0), doors EI <sub>2</sub> 30-C5S <sub>200</sub>  |
| - Level III (+)             | - REI/EI 45 (A1 or A2-s1,d0), doors E 30-C5S <sub>a</sub>                  |

- **Level IV** - **REI/EI 30 (min B-s1,d0), doors EI<sub>2</sub> 15-C5S<sub>a</sub>**
- **Level V** - **REI/EI 15 (min C-s1,d0), doors C5**

**(15)** In production/storage buildings, the following fire stopping walls may be provided, having at least\* the following performance levels:

- **Level I** - **REI/EI 120 (A1 or A2-s1,d0), doors EI<sub>2</sub> 60-C5S<sub>200</sub>**
- **Level II** - **REI/EI 120 (A1 or A2-s1,d0), doors EI<sub>1</sub> 60-C5S<sub>200</sub>**
- **Level II (+)** - **REI/EI 90 (A1 or A2-s1,d0), doors EI<sub>2</sub> 45-C5S<sub>200</sub>**
- **Level III** - **REI/EI 60, doors E 30-C5S<sub>a</sub>**
- **Level IV** - **REI/EI 30, doors E 15-C5S<sub>a</sub>**
- **Level V** - **doors C3**

**(16)** Fire protection partitions that limit the spread inside fire compartments are used for:

- splitting\* large areas (e.g. large civilian buildings);
- minimum separation\* of administrative areas from production and storage facilities (depending on the density of heat load in adjacent spaces) when administrative areas are not constituted as distinct fire compartments;
- minimum insulation\* of production facilities, machinery, used in the production process where necessary (depending on the density of heat load in adjacent spaces);
- minimum structural separation\* between certain different areas of use (depending on the density of heat load in adjacent spaces), where such zones are not constituted as separate fire compartments;
- minimum constructive separation\* between areas protected by automatic fire extinguishing systems and unprotected areas (depending on the density of heat load in adjacent spaces);
- minimum constructive\* separation of open space areas where their areas exceed the permitted value by **400 m<sup>2</sup>** and the saturated spaces do not generate more restrictive performance (depending on the density of the heat load in adjacent spaces).

General note\*: with validity only when the adjacent spaces do not generate more restrictive performances (no higher requirements corresponding to the heat load densities (q) from the adjacent spaces and/or the highest heat load densities (q) from the spaces they separate) and/or when the separation is not constituted as a separate fire compartment.

**(17)** The partitioning walls with the role of limiting the spread of fire (of protection against fires that limit the spread inside the fire compartments) must **NOT** section the construction along its entire height.

**(18)** The attic of above-ground civil constructions is ensured by making sections of the building according to **Art. 3.1.2.9. paragraph 1**. Atticing above-ground civil constructions (creating a functional level in the volume of the attic) is allowed if the fire-resistant partition walls exceed a minimum of 30 cm, according to **Art. 3.1.2.9. paragraph 2** and the following figures:

## **ANNEX 2.4 - FIRE WALLS AND PARTITIONS**

**(19)** The fire walls shall be located according to the level of fire stability of the building or fire compartment and their functions in conjunction with the type of construction as specified in Table 125.

**(20)** The partition walls are mandatory in the cases established by the regulations and for the situation of buildings classified in fire stability level **I** (except for high and very high buildings) or **II** (when full coverage fire detection, signalling and alarm systems, automatic fire extinguishing systems and smoke evacuation from common horizontal circulation, i.e. corridors/ hallways and stairwells) for which the **built-up area is not limited**, as provided for in letter c) of Table 41:

Conditions for correlation of built areas (Ba) of civil above-ground buildings and fire compartments to the level to be stabilised at fire.

*(21) Sector walls when positioned between two or more fire compartments shall be shaped as fire walls.*

*(22) In cases where the designed building will be within the maximum permissible number of storeys above ground specified in Table 125, but the fire stability level is higher, then composite full facade thermal insulation systems corresponding to the designed fire stability level shall be chosen, but shall not be taken into account in determining the fire stability level.*

## **ANNEX 3 - LIMITING THE SPREAD OF FIRE ON THE FAÇADE**

### **ANNEX 3.1 – GENERAL PROVISIONS**

*(23) It is mandatory for perimeter closures of any kind of construction to be constructed and carried out in such a way as to delay the spread of fires from one level to another, both outside the perimeter closure (on the front) and through the interior of the construction, in accordance with the rules laid down.*

*(24) In order to delay the spread of fire through the interior of the building, gaps between the floor slabs and the curtain wall as well as between the floor slabs and other types of exterior walls anchored to the load-bearing structure of the building (e.g. sandwich panel facade type) shall be sealed with sealing systems having the same fire resistance as the floor slab:*

- in buildings of normal height:
  - i. minimum fire resistance **EI 30**;
- in high buildings:
  - i. minimum fire resistance **EI 60**;
- in very high buildings below the height of **125 m**:
  - i. minimum fire resistance **EI 90**;
- in very high buildings of higher height or equal to **125 m**:
  - i. minimum fire resistance **EI 120**.

### **ANNEX 3.2 – RULE H + L**

*(25) In cases where the Rules explicitly states, the vertical elements may be added together with horizontal elements having the same fire resistance (same time period) according to Figure 42 - Summary concept of vertical elements with the same fire resistant horizontal elements (general case).*

#### **Definition of H and L indices (definition)**

*(26) Index 'H' generally represents the vertical distance which must be equal to either **1.20 m** or the value of the characteristic index determined by summing the heights (b+c+d). When the openings/windows in the facade are not superimposed, the H index shall be measured against the shortest distance between these gaps/windows.*

*(27) Index 'L' means the horizontal distance between the outer plane of the boundary elements and the outer face of the facade members, measured directly above the superimposed openings, including the elbows, if they form a fire-resistant obstacle. The measurement shall be made over the largest width of the superimposed gaps in the facades. This value should only be taken into account when it is greater or equal to **15 cm**.*

(28) Examples of measurements **H** and **L** and implementing rules for more complex cases are given below in the Annex.

### **Constructive solutions with H + L**

(29) The following may be taken into account:

Superlight offset on a fully glazed façade (variant a)

In order to take into account the height of a superlight in the calculation of **H**, the setback **L<sub>1</sub>** must not exceed **40 cm**, measured in relation to the area of the interior glazing.

Flat or curved multi-sloped facade (opaque part and glazed part) (variant b) and (variant c)

Façade inclined inwards (variant b):

Whatever the value of angle  $\alpha$ , the general rule **H+L** applies (if **L**  $\geq$  **15 cm**).

Facade inclined outwards (variant c):

If  $\alpha \leq 15^\circ$ : the facade rules apply, measuring **H** with respect to the vertical and **L** equals **0**.

If  $\alpha > 15^\circ$ : the facade of the lower level below the inclined level must be **A1, A2s1do, EI i**  $\rightarrow$  o the same framing with the level required for the fire stability of the structure of the building's floors.

Secluded upper floor (variant d)

**L** is taken into account only if its value is greater than or equal to **15 cm** (**L**  $\geq$  **15 cm**).

Upper floor in the console (variant e) and (variant f)

Projection value **L'** to be taken into account in the calculation of **L**, only if greater than **80 cm** and value of withdrawal **d'** is only taken into account in its calculation **L** only if greater than **15 cm**

$$L' \leq 80 \text{ cm and } d' < 15 \text{ cm} \Rightarrow L=0$$

$$L' \leq 80 \text{ cm and } d' \geq 15 \text{ cm} \Rightarrow L=d'$$

$$L' > 80 \text{ cm and } d' < 15 \text{ cm} \Rightarrow L'=L-80 \text{ cm}$$

$$L' > 80 \text{ cm and } d' \geq 15 \text{ cm} \Rightarrow L'=(L-80 \text{ cm})+d$$

### **Windows and balcony/terrace doors**

(30) Parts that open (doors, windows, or equivalent) and do not have the same fire resistance / tightness classification as the continuous areas that can be summed for the constructive solution **H + L** (generally **1.20 m** of the canopy elements / terrace), are not taken into account when measuring the **H** index.

(31) Balconies or consoles, located in front of an opening and that meet the requirements of resistance (**R**) and reaction to fire according to the regulations are taken into account when measuring the **L** index.

(32) 'L' means the shortest distance of the balcony/console measured perpendicular to the façade.

**ANNEX 3.3 - STRIPS FOR COMPOSITE THERMAL INSULATION SYSTEMS -  
PRINCIPLES FOR THE CONSTRUCTION OF STRIPS AND STRIPS FOR  
THERMAL INSULATION AND/OR COMPOSITE EXTERIOR THERMAL  
INSULATION SYSTEMS OF PERIMETRIAL WALLS, OTHER THAN A1, A2-s1d0**

**(33)** For all constructions, the external thermal insulation and/or external thermal insulation composite systems (end-use compact systems) of the perimeter walls shall be fire reaction class as specified in **Art. 2.3.6.1.8.** and Table 16: External thermal insulation and/or composite thermal insulation systems (compact systems under end-use conditions) on solid facades or with glazed elements or other unprotected gaps (for different functions/building types).

**(34)** In all cases, account shall be taken of the provisions laid down in **Article 2.3.6.1.9.**

**(35)** For thermal insulation and/or composite external thermal insulation systems for perimeter walls other than **A1, A2-s1d0**, the following principles shall be used (as shown in Figure 108):

- Full bonding of the facade/tape (reaction class to fire **A1, A2-s1d0**) on a backing
- Screw or metal nail
- Bonding or embedding insulation to the backing
- Thin or thick plastering system
  - $t < 200 \text{ mm}$  - 1 strip
  - $t \geq 200 \text{ mm}$  - 2 strips (recommendation)

**(36)** On the facades of perimeter walls of buildings provided with thermal insulation and/or composite external thermal insulation systems of perimeter walls other than **A1, A2-s1d0**, including gaps (doors and/or windows) in the masonry, continuous horizontal bands/strips of thermal insulation of reaction to fire class **A1 or A2-s1d0** shall be made according to Figure 109.

**(37)** On the facades of perimeter walls of buildings provided with thermal insulation and/or composite external thermal insulation systems of perimeter walls other than **A1, A2-s1d0**, without gaps in the masonry, in the case of a thick plaster system, continuous horizontal bands/strips of thermal insulation of reaction to fire class **A1 or A2-s1d0** shall be made according to Figure 110. A single strip shall be applied at the lower start of the fuel heat-insulation (the bottom of the band/strip at a maximum distance of 600 mm above the beginning of the thermal insulation).

**(38)** On the façades of perimeter walls of buildings equipped with thermo-insulation and/or composite external thermal insulation systems for perimeter walls other than **A1, A2-s1d0**, without gaps in masonry, in the case of a thin plastering system, the construction of continuous horizontal heat-insulation bands/strips class reaction to fire **A1 or A2-s1d0** perform as shown in Figure 111. For thin rendering systems, the bands/strips shall be installed as follows:

- at the lower start of the fuel heat-insulation (bottom of the band/strip, a maximum distance of 600 mm above the start of the thermal insulation/thermal insulation composite systems);
- level 1 (between ground floor and 1th floor covered with thermal insulation or combustible thermal insulation composite systems) and level 2 (between floors 1 and 2 covered with thermal insulation or combustible thermal insulation composite systems).

**(39)** On the facades of perimeter walls of buildings provided with thermal insulation and/or composite external thermal insulation systems of perimeter walls other than **A1, A2-s1d0**, the protection of openings by thermal insulation cladding of reaction to fire class **A1 or A2-s1d0** (for wall-mounted joinery) shall be carried out as follows, according to Figure 112

- **variant a)**  $H \geq 1.20 \text{ m}$  - protection of openings through heat-insulation kits class reaction to fire **A1 or A2-s1d0** (wall joinery) for  $H \geq 1.20 \text{ m}$ :
  - only applicable to wall joinery facades, index  $H$  (from  $H + L$ ) being  $H$

≥ 1.20 m

- protective strips bordering gaps can be applied continuously between the gaps and on their side; these strips have the same thickness as thermal insulation and/or thermal insulation composite systems other than the reaction to fire class **A1** or **A2-s1d0**; example: the characteristics of the thermal insulation used to make these edging strips can be: basaltic mineral wool according to **SR EN 13162**, Euroclass **A1** (the basaltic mineral wool band will be completely bonded to perimeter walls).

- **variant c) H < 1.20 m** - protection of openings through heat-insulation kits class reaction to fire **A1** or **A2-s1d0** (wall joinery) for **H < 1.20 m**

- only applicable to wall joinery facades, funnel index **H** (of **H + L**) being **H < 1.20 m**

**(40)** On the facades of perimeter walls of buildings provided with thermal insulation and/or composite external thermal insulation systems of perimeter walls other than **A1, A2-s1d0**, on the same facade, where the **H**-index (of **H + L**) is **H < 1.20 m**, continuous horizontal bands/strips of thermal insulation of reaction to fire class **A1** or **A2-s1d0** shall be made according to Figure 113 **Variant a)** (left side of the picture). On the facades of perimeter walls of buildings provided with thermal insulation and/or composite external thermal insulation systems of perimeter walls other than **A1, A2-s1d0**, on the same facade, where the **H**-index (of **H + L**) is **H < 1.20 m**, continuous horizontal bands/strips of thermal insulation of reaction to fire class **A1** or **A2-s1d0** at the corners shall be made according to Figure 113 **Variant b)** (left side of the picture).

**(41)** On the facades of perimeter walls of buildings provided with thermal insulation and/or composite external thermal insulation systems of perimeter walls other than **A1, A2-s1d0**, including embeddings/retractions, in the case of a thin plaster system, continuous horizontal bands/strips of thermal insulation of reaction to fire class **A1** or **A2-s1d0** shall be made according to Figure 114. The principle is for facades without gaps in the masonry, except for the recessed facade (for the recessed facade the index **H** (of **H + L**) is **H < 1.20 m**). When the previous solution is applied on a recessed/retracted facade, the portion between the windows and the two adjacent facades must also have thermal insulation applied continuously, between the gaps and on their side, fire reaction class **A1** or **A2-s1d0**, regardless of whether they are without or with openings.

**(42)** The principle of over-thermal insulation in composite external thermal insulation systems of perimeter walls, provided with thermal insulation of external perimeter walls different from existing **A1, A2-s1d0**, implies (as shown in Figure 115):

- Full strap bonding on the substrate

- Screw or metal nail

- Calibration on existing insulation other than **A1, A2-s1d0** (thin or thick plaster system)

**(43)** If the integrated balcony/console is integrated into the construction structure and participates in the index **H + L** (e.g. when complying with the principles set out in **Article 2.3.6.1.2.**), the arrangement of the continuous strips/bands shall follow the principles illustrated in Figure 116. **(Variant a)**, principle for the construction of continuous horizontal heat-insulation bands/strips class reaction to fire **A1** or **A2-s1d0** in height 'H' of the balconies and consoles that form an integral part of the structure).

**(44)** If the balcony is detached from the main structure of the building, the arrangement of the continuous bands/strips shall comply with the principles illustrated in Figure 116 **(Variant b)**, principle of making continuous horizontal bands/strips of thermal insulation reaction to fire class **A1** or **A2-s1d0** on the height "H" of balconies and brackets which are **not** an integral part of the structure). The balcony separated from the structure does not participate in the sum of indicia **H+L**.

*(45) On the recessed access portions that break the overlap band at the bottom of the thermal insulation and/or composite thermal insulation systems other than **A1, A2-s1d0** (depending on their depth) of the perimeter wall facades of buildings provided with thermal insulation and/or composite external thermal insulation systems of perimeter walls other than **A1, A2-s1d0**, including gaps (doors and/or windows) in the masonry, is achieved by the interposition of thermal insulation of reaction to fire class **A1 or A2-s1d0**, as shown in Figure 117.*

*(46) On the facades of perimeter walls of buildings provided with thermal insulation and/or composite external thermal insulation systems of perimeter walls other than **A1, A2-s1d0**, comprising large openings (where the height of the opening exceeds the height of the floor between two storeys), this is achieved by interposing continuous horizontal bands/strips of thermal insulation of reaction to fire class **A1 or A2-s1d0**, as shown in Figure 118.*

*(47) On the facades of perimeter walls of buildings provided with thermal insulation and/or composite external thermal insulation systems of perimeter walls other than **A1, A2-s1d0**, comprising recessed lower storeys, continuous horizontal bands/strips of thermal insulation of reaction to fire class **A1 or A2-s1d0**, as shown in Figure 119, are interposed.*

*(48) On the perimeter wall facades of buildings provided with thermal insulation and/or composite external thermal insulation systems of perimeter walls other than **A1, A2-s1d0**, including facades with loggias (irrespective of their depth), continuous horizontal bands/strips of thermal insulation of reaction to fire class **A1 or A2-s1d0** are interposed, as shown in Figure 120.*

*(49) On the facades of perimeter walls of buildings provided with thermal insulation and/or composite external thermal insulation systems of perimeter walls other than **A1, A2-s1d0**, comprising facades with different openings (facades with openings with height less or greater than the others with  $L > 500$  mm and  $200 \text{ mm} < h < 500$  mm), it is achieved by interposing continuous horizontal bands/strips of thermal insulation reaction to fire class **A1 or A2-s1d0**, according to Figure 121.*

*(50) On the facades of perimeter walls of buildings provided with thermal insulation and/or composite external thermal insulation systems of perimeter walls other than **A1, A2-s1d0**, on dropped facades of different heights, continuous horizontal bands/strips of thermal insulation of reaction to fire class **A1 or A2-s1d0** are interposed, as shown in Figure 122. In the case of gaps between storeys, the principles of construction on facades with different spans above apply.*

*(51) On facades of perimeter walls of buildings with thermal insulation and/or composite external thermal insulation systems of perimeter walls other than **A1, A2-s1d0**, on sloping ground, continuous horizontal bands/strips of thermal insulation of reaction to fire class **A1 or A2-s1d0**, as shown in Figure 123, shall be used.*

## **ANNEX 4 – CONSTRUCTIVE COMPOSITIONS**

### **ANNEX 4.1 – LIFTS**

#### **Lifts – General**

*(52) Lifts for the functional movement of persons and in general of vertical transport systems shall be separated from the rest of the construction by vertical and, where appropriate, horizontal elements, reaction to fire class **A1 or A2-s1d0** and fire resistant corresponding to the level of fire stability provided, building type and destination, according to **Article 2.4.4.2.1 paragraph 1**. Only access (pallier) gaps in the construction levels are permitted. Access openings to lifts intended for the functional movement of persons (able-bodied or disabled) shall be protected by fire-resistant*

doors in accordance with Art. 2.4.4.2.5. paragraph 1 and Art. 2.4.4.2.1. paragraph 2, paragraph 3, paragraph 4 and paragraph 5. *In all cases, account shall be taken of the provisions laid down in **Article 2.4.4.2.5 paragraph 2 and paragraph 3.***

*(53) In civil buildings of normal height separation walls from the rest of the construction of cargo lifts shall comply with **Article 2.4.4.2.4 paragraph 1.** Access openings to small material lifts (monte-charge type), electric or hydraulic, shall be protected by fire-resistant doors in accordance with Art. 2.4.4.2.1. paragraph 3. Landing gaps through which users have access to goods lifts in civil buildings of normal height shall be protected by doors in accordance with Art. 3.1.4.3. paragraph 2.*

*(54) A maximum of three lift cabs or mechanical vertical means of transport (cabins intended for the functional movement of persons, cargo, monte-charge or lifting platforms, etc.) are permitted in a single well, as shown in Figure 124.*

### **Lifts for the evacuation of disabled persons and emergency lifts**

#### **Lifts intended for the transport of wheelchair users or disabled persons which can also be used for their assisted evacuation in the event of fire**

*(55) Lifts for the transport of persons with wheelchairs or persons with disabilities which can also be used for assisted evacuation in the event of fire must be provided in buildings with persons who cannot evacuate themselves (defined according to the terminology) and additionally according to **Art. 2.4.4.3.3.***

*(56) Lifts intended for the transport of sick persons by wheelchair, stretcher or trolley or of disabled persons which can also be used for their assisted evacuation in the event of fire must be provided in health care or mixed health care buildings where the evacuation of users in the event of fire must be carried out by wheelchair, stretcher or trolley.*

*(57) Lifts intended for the transport of persons with wheelchairs or disabled persons which can be used and for their assisted evacuation in the event of fire shall be arranged in their own shaft separated from the rest of the building by fire-resistant walls and fire-resistant floors in accordance with the building regulations:*

- **Article 3.1.4.4 paragraph 2** for buildings of normal height;
- **Article 4.1.4.13 paragraph 1 letter a)** for high buildings;
- **Article 4.2.4.13 paragraph 1 letter a)** for very high buildings.

*(58) Lifts intended for the transport of wheelchair users or disabled persons which can also be used for their assisted evacuation in the event of fire must simultaneously comply with the provisions:*

- **Article 3.1.4.4 paragraph 3 letters c), d), e), f) and g)** for buildings of normal height;
- **Article 4.1.4.13 paragraph 1 letter b)** and **Article 3.1.4.4 paragraph 3 letters c), d), e), f) and g)** for high buildings;
- **Article 4.2.4.13 (1) b)** and **Article 3.1.4.4 paragraph 3 letters c), d), e), f) and g)** for very high buildings.

*(59) Access to lifts intended for the transport of wheelchair users or people with disabilities which can also be used for their assisted evacuation in the event of fire must comply with the provisions:*

- **Article 3.1.4.5 paragraphs 1 ÷ 4** for buildings of normal height;
- **Article 4.1.4.13 paragraphs 2 ÷ 7** for high buildings;
- **Article 4.2.4.13 paragraphs 2 ÷ 7** for very high buildings.



## **Lifts designed for the transport of sick people in wheelchairs, stretchers or trolleys or disabled people which can also be used for assisted evacuation in case of fire**

**(60)** Lifts intended for the transport of sick persons by wheelchair, stretcher or trolley or of disabled persons which can also be used for their assisted evacuation in the event of fire must be provided in health care or mixed health care buildings where the evacuation of users in the event of fire must be carried out by wheelchair, stretcher or trolley.

**(61)** Lifts intended for the transport of sick persons by wheelchair, stretcher or trolley or disabled persons which can also be used for their assisted evacuation in the event of fire in health care buildings (or mixed health care buildings where evacuation of users in the event of fire must be carried out by wheelchair, stretcher or trolley) shall be arranged in their own shaft separated from the rest of the building by fire-resistant walls and conforming fire-resistant floors:

- **Article 3.2.4.4 paragraph 6** for buildings of normal height;
- **Article 4.1.4.13 paragraph 1 letter a)** for high buildings;
- **Article 4.2.4.13 paragraph 1 letter a)** for very high buildings.

**(62)** Lifts intended for the transport of sick persons by wheelchair, stretcher or trolley or disabled persons which can also be used for their assisted evacuation in the event of fire in health care buildings (or mixed health care buildings where the evacuation of users in the event of fire must be carried out by wheelchair, stretcher or trolley) must simultaneously comply with the provisions:

- **Article 3.2.4.4 paragraph 6 letter b)** and **Article 3.1.4.4 paragraph 3 letters c), d), e), f) and g)** for buildings of normal height;
- **Article 4.1.4.13 paragraph 1 letter b)** and **Article 3.1.4.4 paragraph 3 letters c), d), e), f) and g)** for high buildings;
- **Article 4.2.4.13 (1) b)** and **Article 3.1.4.4 paragraph 3 letters c), d), e), f) and g)** for very high buildings.

**(63)** Access to lifts intended for the transport of sick people in wheelchairs, stretchers or trolleys or disabled people which can also be used for their assisted evacuation in the event of fire in health care buildings (or mixed health care buildings where evacuation of users in the event of fire must be carried out by wheelchair, stretcher or trolley) must comply with the provisions:

- **Article 3.2.4.4 paragraphs 7, 8 and 9** for buildings of normal height;
- **Article 4.1.4.13 paragraph 8 and paragraph 9** for high buildings;
- **Article 4.2.4.13 paragraph 8 and paragraph 9** for very high buildings.

### **Intervention lifts**

#### **General provisions**

**(64)** Emergency lifts in the event of fire (fire brigade) are mandatory in the situations set out in the regulations and in addition in accordance with **Article 2.4.4.4.2**.

**(65)** The lifts provided for fire intervention (by the fire brigade) shall be arranged in their own shaft separated from the rest of the building by fire-resistant walls and fire-resistant floors:

- **Article 3.1.4.7 paragraph 1** for buildings of normal height;
- **Article 4.1.4.15 paragraph 2** for high buildings;
- **Article 4.2.4.15 paragraph 2** for very high buildings.

**(66)** Lifts intended for intervention in the event of fire (fire brigade) shall comply with the provisions of:

- **Article 3.1.4.8 paragraphs 5 ÷ 14** for buildings of normal height;
- **Art. 3.1.4.8. paragraphs 3 ÷ 8, Art. 3.1.4.8. paragraphs 11 ÷ 14 and Art. 4.1.4.14. and Art. 4.1.4.15. paragraph 1 and paragraphs 5 ÷ 7** for tall buildings;

- **Art. 3.1.4.8. paragraphs 3 ÷ 8, Art. 3.1.4.8. paragraphs 11 ÷ 14 and Art. 4.2.4.14. and Art. 4.2.4.15. paragraph 1 and paragraphs 5 ÷ 7** for very tall buildings.

**(67)** Access to lifts provided for fire response (by fire brigade) must comply with the provisions:

- **Article 3.2.4.4 paragraphs 7, 8 and 9** for buildings of normal height;
- **Article 4.1.4.15 paragraph 3 and paragraph 8** for high buildings;
- **Article 4.2.4.15 paragraph 3 and paragraph 8** for very high buildings.

### **Intervention lifts**

**(68)** The escape flows where the staircase is provided for evacuation as well as for access of the emergency forces shall be conformed according to Table 126.

### **Well protected from access and intervention by firefighters**

**(69)** In buildings with a height of **75 m** or more, at least one emergency lift must be provided with access from the buffer room of the stairwell intended solely for firefighters.

**(70)** "Protected fire access and intervention shaft" refers to an overpressure ventilated buffer room from which an intervention lift is accessed and which has direct access to a protected ladder for firefighting purposes (intended for firefighter intervention only). It is mandatory for very tall buildings higher than **75 m** and is recommended for tall buildings and very tall buildings less than or equal to **75 m** as well as hospital buildings higher than **4** storeys above ground with users who cannot evacuate themselves and other types/functions of buildings.

**(71)** The floor of the overpressure ventilated buffer room shall be graded from the lift door to the door(s) of the overpressure ventilated buffer room with a maximum slope of **1: 200** to prevent the escape of water into the lift well. The ventilated buffer room in excess pressure provides a buffer zone to prevent smoke from entering the protected ladder. It acts as a working area for firefighters in carrying out firefighting operations and it is necessary to limit the size to max. **10 m<sup>2</sup>** to prevent the overpressure ventilated buffer room being used for other purposes.

1). The shaft must be fully protected to a minimum of **REI 240** in very tall buildings over **75 m** in height (or **REI 180/ REI 120** if provided in other building types/functions), with protection involving the lift, the overpressure ventilated buffer room and the protected staircase.

2) The ladder shall be complied with as a pressurised intervention scale according to **SR EN 12101-13**, with the pressurisation class required for intervention (this may require open doors during the intervention).

3) If the lift is only used for access by intervention forces, the clear width of the stairway ramp and the access doors to it shall have dimensions free of min. **90 cm** and the door at the intervention lift has the dimensions free of min **80 cm**.

**(72)** The lift shall be designed in such a way that it can function correctly under the conditions of the **SR EN 81-72**. Electrical equipment in the fire lift shaft and on the car located up to **1.0 m** from a wall containing a landing door must be protected against dripping and splashing water or must be fitted with enclosures with a protection rating of at least **IP X3** according to **EN 60529**. All electrical equipment situated less than **1.0 m** from the bottom floor shall have a protection degree of **IP 67**. Equipment located in the machinery space outside the well and in the sump must be protected against malfunctions caused by water. The well must be equipped with suitable means to ensure that the water level does not rise above the level of the fully compressed cabin pads. Means shall be provided to prevent the water level in the foundation from reaching equipment which could create a malfunction of the fire lift.

## ANNEX 4.2 – ATRIUMS

### General atriums

(73) The atrium whose free volume is closed on all sides and whose minimum width is less than or equal to the height of the highest facade and which is open at the top at least 90%, is considered an open atrium.

(74) The smallest dimension of an atrium is defined as the diameter of the cylinder inscribed over the whole height of the atrium in the clearance between:

- the ends of open atrium balconies;
- vertical walls for closed atriums;
- ends of balconies and vertical walls for open atriums on one side and closed on the other side.

(75) The basic section of the atrium is the largest of the horizontal sections included among the building elements delimiting the atrium (according to the previous paragraph). At each level, the section of the gap between building elements shall be at least equal to half of this basic section.

(76) The base volume of the atrium is the product of the base section multiplied by the total height of the atrium measured at the ceiling of the last tier.

(77) Atrium whose dimensions are specified above and which is totally or partially covered (**10 % or above**) is considered a covered atrium. Two types of coated atriums are distinguished in this category:

- open coated atriums are volumes in which one or more tiers are permanently opened to the central volume.
- enclosed coated atriums are volumes where all levels (except the lower level) are closed laterally by walls, even if gaps exist in these lower level walls, or if the levels have balconies or open horizontal circulation between the walls and the volume of the atrium.

(78) The provisions of the legislation refer to those covered atriums which have a minimum of at least  $\sqrt{7H}$  of their height (in which **H** is the smallest atrium height) and having at least four levels on one or more sides of the building adjacent to the atrium.

(79) When creating atriums, patios or courtyards of light on less than **4 levels** and covered, the filled areas with a height of at least **1.20 m**, between the levels, next to the floors, must be **E 30**.

### Atrium types

(80) VARIANT 1: The building has atrium, the double-deck area having a minimum of 4 levels.

(81) VARIANT 2: The building was considered without an atrium, having less than 4 levels. When creating atriums, patios or courtyards of light on less than **4 levels** and covered, the filled areas with a height of at least **1.20 m**, between the levels, next to the floors, must be **E 30**.

(82) ATRIUM (PATIO, COURT OF LIGHT) closed enclosure inside a building, delimited on one or more sides by at least four levels of the building.

(83) Atriums may be uncoated or covered.

(84) The atriums treated in the standard are those that meet the conditions:

- 1) are bounded on one or more sides of at least four levels of the building;
- 2) are covered and have at least two  $\sqrt{7H}$  ( $H$  being the smallest atrium height).
- 3) fulfil condition  $l \geq \sqrt{7H}$  .

**(85)** In the production of narrower covered atriums (width less than  $\sqrt{7H}$  ), the flue effect in the event of fire shall be increased and one of the following additional measures specified in **Article 2.4.9.11 paragraph 2**.

#### **Atrium location**

**(86)** The location of atriums in relation to the building may be adjacent (on one to three sides) or embedded.

**(87)** Compared to building levels, the atrium can be closed with full walls, vitreous or unclosed walls.

**(88)** Storage of combustible materials and/or substances, not separated from the atrium, is **NOT ALLOWED**.

**(89)** In atrium buildings it is not recommended to have adjacent spaces, not separated from the atrium, with a high fire risk, and when these are foreseen (commerce, exhibitions and similar with heat load density -  $q$  over **840 MJ/m<sup>2</sup>** these spaces must be equipped with detection, signalling and alarm systems and fire extinguishing machines. Where spaces with functions of health, educational accommodation, trade, exhibitions and the like are provided adjacent to the atrium, it shall be provided with smoke and hot gas evacuation systems in the event of fire.

**(90)** Deposits of combustible materials and/or substances shall be separated from atriums with fire resistant elements, constructed and sized in accordance with the density of the heat load ( $q$ ) from those deposits, but not less than **EI 120**.

#### **Common horizontal circulation open to the atrium**

**(91)** Common horizontal circulation routes open to the atrium shall be provided at their boundary to the atrium (under the floors) with continuous screens having a height of at least **50 cm** and fire resistance of not less than **DH 60** for fire stability levels **I and II**, and not less than **DH 30** for the other fire stability levels, and with sprinklers suitably located with an operating time of not less than 60 minutes if the adjacent spaces are equipped with such installations; continuous beams of the structure having a height of at least **50 cm** underneath the floor, from which they can continue with continuous screens. Common horizontal circulations closed towards the atrium, are provided at their limit towards the atrium with carpentry panels that are separated by solid continuous areas (parapets), fire resistant at least **EI 60** for levels I and II of fire stability, respectively minimum **EI 30** for the other fire stability levels and the minimum height of **1.20 m** or according to **Art. 2.4.9.4. 2**.

### **ANNEX 4.3 - CONSTRUCTIONAL COMPOSITIONS SPECIFIC TO THE RISK OF VOLUMETRIC EXPLOSION**

#### **Rooms and spaces with explosion hazard**

##### **Terminology:**

**(92) Explosion** (of an explosive atmosphere) - Abrupt recovery of pressure and temperature due to oxidation or other exothermic reaction.

**Gaseous explosive atmosphere** - Mixture with air, under normal atmospheric conditions, of flammable substances in the form of a gas, vapour or mist in which, after ignition, combustion spreads into the whole of the unconsumed mixture.

**Explosive atmosphere with dust** - Mixture with air, under normal atmospheric conditions, of flammable substances in the form of dust or fibres in which, after ignition, combustion spreads throughout the unconsumed mixture.

**(93) Danger area (due to gaseous explosive atmospheres)** - Area where there is or may be present a gaseous explosive atmosphere in such quantities, requiring special precautions for the construction, installation and use of electrical equipment.

**(94) Hazardous area (dust)** - An area in which fuel dust in the form of cloud or layer is, or may be expected to be present in such quantities, requiring special measures for the construction and use of electrical equipment, in order to prevent the ignition of an explosive mixture of dust/air or a layer of combustible dust.

**(95) Non-hazardous area (due to gaseous explosive atmospheres)** - Area where an explosive atmosphere in gas or with combustible dust cannot be present in such quantities as to require special precautions for the construction, installation and use of electrical equipment.

**(96) Non-hazardous area (dust)** - Area where combustible dust is not present in sufficient quantity to allow the formation of significant explosive dust/air mixtures and/or layers of combustible dust.

**Zone 0** - Area where a gaseous explosive atmosphere is present on a permanent basis or for long periods of time.

**Zone 1** - Area where a gaseous explosive atmosphere is likely to occur during normal operation.

**Zone 2** - Area where a gaseous explosive atmosphere is unlikely to occur during normal operation and where, if this does occur, it is likely to only happen on rare occasions and for a short period of time.

Indications of occurrence and duration may be obtained from the codes specific to certain industries or applications.

**Zone 20** - Area where fuel dust, in the form of cloud, is present permanently or frequently in sufficient quantity to produce an explosive concentration of combustible dust mixed with air, and/or where the dust layer can be formed with an excess thickness and not controlled during normal operation.

This can happen within a confined dust space where dust can form explosive mixtures, frequently or over long periods. This typically occurs inside the equipment.

**Zone 21** - An unclassified area as Zone 20 in which, during normal operation, combustible dust in the form of a cloud is likely to occur in sufficient quantity to be capable of producing an explosive concentration when mixed with air.

This area may include, inter alia, the immediate vicinity of the points of supply or disposal of spray products and areas where dust layers are drilled and it is likely that during normal operation it will result in an explosive concentration of combustible dust mixed with air.

**Zone 22** - Area not classified as Zone 21, where dust clouds may occur infrequently and persist for short periods or where accumulations or layers of combustible dust may be present under abnormal conditions and may generate explosive dust mixtures in the air. When the removal of accumulations or layers of dust cannot be ensured due to abnormal conditions, this area is classified as zone 21.

This area may include, among other things, areas in the vicinity of equipment containing dust that may leak and form deposits (crushing rooms, for example, where dust may escape from crushing and settle).

**Lower explosive limit LEL (abbreviations)** - The concentration of flammable gases, vapours or waxes in the air up to which an explosive gaseous atmosphere does not form.

**(97)** The classification of ATEX areas depends on the presence of explosive mixtures in the area.

Gas and vapour ATEX areas

Zone 0 / Category 1G

Zone 1 / Category 2G

Zone 2 / Category 3G

ATEX areas for dust

Zone 20 / Category 1D

Zone 21 / Category 2D

Zone 22 / Category 3D

### **Rooms and spaces with explosion hazard**

#### **Constructive measures in areas with explosion hazard**

**(98)** Where rooms (spaces) with an explosion hazard (very high risk and volumetric explosion) cannot be arranged outside construction for other purposes, the protective measures provided for in the technical regulations shall be taken, given that the layout of rooms with an explosion hazard is not recommended at the lower levels of a double-deck construction with another purpose.

**(99)** When rooms with explosion hazard are arranged in constructions for other purposes, they shall be separated by explosion resistant elements (walls, floors). Blast-resistant floors must meet the conditions of the respective blast-resistant walls.

**(100)** Explosion resistant elements shall also ensure that the propagation of fires from spaces adjacent to that of danger of explosion (fire resistance according to thermal load density) is prevented.

**(101)** Functional communication gaps in blast resistant walls shall be protected by protected buffer rooms provided with **EI/REI 120** fire resistant walls (except the wall to the room with very high fire and volumetric explosion risk which must be minimum **REI 180**) and 2 doors x **EI<sub>2</sub> 90-C5S<sub>200</sub>**.

**(102)** Rooms with explosion hazard shall not have suspended ceilings and non-ventilated areas.

**(103)** Enclosed rooms and spaces with explosion hazard shall be provided with decompression gaps in the event of explosion.

**(104)** The rooms of heating plants equipped with a solenoid valve and an automatic gas detector shall be provided with pressure relief gaps in the event of an explosion with an area of at least **0,02 m<sup>2</sup> per 1 m<sup>3</sup>** of room volume.

Determination of the surface dimensions of the pressure discharge areas (decompression gaps in case of explosion) shall be done according to the following formula (except for the spaces in the previous paragraph):

$$A_{ex} = 0.05 \times V$$

Where:

$A_{ex}$  - the size of the area of the blast pressure relief gap in  $m^2$ ;

$f_{ex} = 0.05$  - specific gap area factor for explosion decompression expressed in  $m^2/m^3$ ;

$V$  - indoor air volume of the enclosure, expressed in  $m^3$ .

**(105)** Decompression gaps may be provided in external walls or roof.

**(106)** Decompression gaps in partitions and separating floors from the rest of the construction are not permitted. If an open drum is used, decompression gaps shall also be provided on the opposite side of the open drum and a baffle wall similar to that in **Art. 2.3.4.1.5** shall be provided towards the open drum. .

**(107)** The gaps provided for decompression in the event of an explosion may be unclosed or closed with closing elements which yield to the pressure caused by the explosion (panels or portions of wall or roof of the easily displaceable or folding type, windows, single-glazed skylights).

**(108)** Folding panels can be hinged (spindles), horizontal or vertical.

**(109)** Ammonium nitrate stores shall be made only of gap-free building materials, reaction to fire class **A1**, taking into account the specific fire-fighting measures in the Safety Data Sheet, and shall as a rule be placed at minimum distances from other buildings as determined by the formulae:

–  $D = 22.2(0.25Q)^{1/3}$  against vulnerable installations and critical infrastructure (corresponding to an explosion overpressure of 5.5 kPa)

–  $D = 17.8(0.25Q)^{1/3}$  against residential buildings, including hotels, motels and other accommodation (corresponding to an explosion pressure of 7 kPa)

–  $D = 10.4(0.25Q)^{1/3}$  against commercial developments including shops, offices and entertainment centres (corresponding to an explosion pressure of 14 kPa)

–  $D = 7.8(0.25Q)^{1/3}$  against other industrial buildings (corresponding to an explosion overpressure of 21 kPa),

where:

$D$  = the distance between the warehouse and any other neighbouring construction, expressed in metres;

$Q$  = the quantity of ammonium nitrate in kilograms.

Note: Distances are rounded up to the nearest multiple of 10 m and are used exclusively for quantities less than the relevant quantities (in tonnes) of substances for the classification of establishments according to Law No 59 of 11 April 2016 (as amended). For locations with high population density (e.g. near a crowded room, a sports stadium, a large shopping centre or a tall/very tall building) the minimum distances will be set with the formula:  $D = 44.4 (0.25Q)^{1/3}$

### **‘Provisions against explosion hazards’ for stationary batteries**

**Similar to: SR EN IEC 62485-2: 2019 (‘Safety requirements for secondary batteries and battery installations Part 2: Stationary batteries) – Chapter 7 ‘Provision against explosion hazards’**

#### 7 Provisions against explosion hazards

7.1 Gas emissions

7.2 Ventilation requirements

7.3 Natural ventilation

7.4 Forced ventilation

7.5 Charging modes

7.6 Overload under fault conditions

7.7 Near the battery

7.8 Prevention of electrostatic discharges in the use of batteries

## 7 Provisions against explosion hazards

### 7.1 Gas emissions

During charging, floating charging and overloading, gases are emitted from all secondary batteries and cells, except for secondary cells that are gas-tight. This is the result of the electrolysis of the water through the overcharge current. The gases produced are hydrogen and oxygen. When emitted into the atmosphere, an explosive mixture may be created if the concentration of hydrogen in air exceeds 4 %.

When the gas emission is experimentally determined on the basis of battery test standards and the resulting value is lower than that used in this standard, then no reduction of ventilation requirements will be allowed.

If the experimental gas emission value is greater than the assumed value in this standard, then the ventilation requirements should be adapted, implicitly increased.

When a cell reaches its full state of charge, water electrolysis takes place according to Faraday law. Under standard conditions, i.e. at 0 °C and 1 013 hPA (standard temperature and pressure under the International Union of Pure and Applied Chemistry):

– 1 Ah decomposes 0.336 g H<sub>2</sub>O in 0.42 l H<sub>2</sub> + 0,21 l O<sub>2</sub>;

– 3 Ah decomposes 1 cm<sup>3</sup> (1 g) H<sub>2</sub>O;

– 26.8 Ah decomposes 9 g H<sub>2</sub>O in 1 g H<sub>2</sub> + 8 g O<sub>2</sub>.

When the charging equipment is switched off, the emission of gas from the cells may be considered to have ended about one hour after the power supply has been shut down.

### 7.2 Ventilation requirements

The purpose of ventilation of premises or enclosures where batteries are located is to maintain the hydrogen concentration below the 4 % vol. threshold called the Lower Explosive Limit (LEL). Spaces or enclosures in which batteries are located may be considered safe to explosion when, by natural or artificial ventilation, the hydrogen concentration is kept below this safety limit.

The minimum airflow rate for ventilation of the battery space or enclosure shall be calculated using the following formula:

$$Q = v \times q \times s \times n \times I_{gas} \times C_{rt} \times 10^{-3} (\text{m}^3/\text{h})$$

**Q** - is the ventilation air flow rate in m<sup>3</sup>/h;

**v** - is the necessary dilution of hydrogen: (100% – 4%) / 4 % = 24;

**q** = 0.42 × 10<sup>-3</sup> m<sup>3</sup>/Ah hydrogen generated at 0 °C;

Comment: for calculation at a temperature of 25 °C, value **q** at 0 °C multiply by the factor 1.095.

**S** = 5, general safety factor;

**s** - is the number of cells;

**I<sub>gas</sub>** - is the gas current at rated capacity mA/Ah for floating charging current **I<sub>float</sub>** or amplifier charging current **I<sub>impulse</sub>**;

**C<sub>rt</sub>** – is the capacity C<sub>10</sub> lead acid cells (Ah), **U<sub>f</sub>** = 1,80 V/cell at 20 °C or C5 capacity for NiCd (Ah) cells, **U<sub>f</sub>** = 1,00 V/cell at 20 °C.

For:  $v \times q \times s = 0.05 \text{ m}^3/\text{Ah}$  the calculation formula for the ventilation air flow is:

$$Q = 0.05 \times n \times I_{gas} \times C_{rt} \times 10^{-3} (\text{m}^3/\text{h})$$

**I<sub>gas</sub>** - the production of gas is determined by the following formula:

$$I_{gas} = I_{float/amp} \times f_g \times f_s (\text{mA/Ah})$$



Where:

$I_{float}$  - is the floating charging current at full charge conditions at a float charging voltage defined at 20 °C;

$I_{ampl}$  - is the amplifier charge current at full charge conditions at an amplifier charge voltage defined at 20 °C;

$f_g$  - is the gas emission factor, the proportion of fully charged current that produces hydrogen;

$f_s$  - it is the safety factor, to take into account possible defective cells that may be found in a string of batteries or older batteries.

Unless otherwise specified by the manufacturer, values for  $I_{float}$  and  $I_{ampl}$  with the supporting data are presented in Table 127 (equivalent to Table 1 of **SR EN IEC 62485-2**):

### **7.3 Natural ventilation**

It is preferable that the necessary ventilation is provided by natural ventilation. If natural ventilation is not possible, forced (artificial, mechanical) ventilation will be implemented.

Rooms or enclosures in which batteries are located require, under naturally ventilated conditions, an air intake and exhaust with minimum clear opening areas calculated according to the following formula:

$$A = 28 \times Q$$

Where

$Q$  - is the fresh ventilation air flow rate ( $m^3/h$ );

$A$  - is the free zone of air inlet and outlet opening ( $cm^2$ ).

NOTE For the purpose of this calculation, the air velocity is assumed to be 0.1 m/s.

Air inlet and venting must be located in an optimal place to create the best conditions for air exchange, i.e. with

- openings on opposite walls;
- minimum separation distance of 2 m at openings on the same wall.

Batteries equipped with hydrogen exhaust systems based on gas collection caps and tubes shall not be covered by any product, test or safety standard. Therefore, the provisions of this standard for ventilation of premises or premises where batteries are installed are mandatory.

### **7.4 Forced ventilation**

Where an appropriate air flow –  $Q$  cannot be achieved by natural ventilation and forced ventilation is used, the charging system shall be connected with the ventilation system or an alarm when the required air flow is not provided, for the selected charging mode.

The air extracted from the battery room shall be evacuated outside the building.

### **7.5 Charging modes**

The usual charging mode for stationary batteries is direct current/constant voltage charging (characteristic IU, see A.3).

Where charging methods other than characteristic IU or characteristic U are used within the limits specified in Table 127 (equivalent to Table 1 of **SR EN IEC 62485-2**), the airflow  $Q$  for ventilation shall be sized according to the maximum output current of the charger. If charging equipment with a variable characteristic is used, then the end-of-charge current considered 25 % of the rated current of the charger shall be used to calculate the ventilation demand.

NOTĂ A variable characteristic charger is a constant resistance charger with a decreasing current when the voltage increases due to the increasing state of charge of the battery.

### **7.6 Overload under fault conditions**

There may be other circumstances, e.g. malfunction of the charger or thermal evaporation conditions, where the battery may produce more gas than the values taken into account in the design of the ventilation.

Precautions shall be taken against malfunction of the charger or thermal evaporation, e.g. by lowering the charging voltage below the voltage in the open circuit or by automatically disconnecting the power supply. Alternatively, ventilation should be calculated to match the maximum charger output current.

### **7.7 Near the battery**

In the immediate vicinity of the battery, dilution of explosive gases is not always ensured. A safety distance must therefore be observed within which incandescent devices (maximum temperature of area 300 °C) capable of producing sparks. The dispersion of the explosive gas depends on the speed of release of the gas and ventilation near the source of release. For the calculation of the safety distance  $d$  from the source of release, the following formula shall be applied, assuming a hemispherical dispersion of the gas. Safety distance  $d$  is also found in B.1. of SR EN IEC 62485-2:2019. For detailed information on the calculation of the safety distance, see Annex B.

$$d = 28.8 \times 3 \sqrt[3]{I_{\text{gas}}} \times \sqrt[3]{C_{\text{rt}}} \quad 3 \text{ mm}$$

Where:

$I_{\text{gas}}$  - is the gas-producing current (mA per Ah);

$C_{\text{rt}}$  - is the rated capacity (Ah).

NOTE: The required safety distance can be achieved by using a partition between the battery and the incandescent device.

Where batteries are an integral part of a power supply system, e.g. in a UPS system, the safety distance  $d$  may be reduced according to the equipment manufacturers' safety calculations or measurements. The level of air ventilation rate must ensure that there is no risk of explosion by keeping the hydrogen content of the air below 1%vol. plus a safety margin at the potential ignition source.

When gases are released from an  $n$ -cell monobloc battery through a single vent opening or cap or tube, then the capacity value used to calculate the safety distance from this opening must be  $C_{\text{rt}} = n \times C_{\text{rt}}$  monobloc battery.

### **7.8 Prevention of electrostatic discharges in the use of batteries**

Wearing clothes and shoes that can generate electrostatic loading is prohibited (see also 9.2 f).

Use only cotton fabric dampened with water to clean the battery. Other cleaning methods such as liquids and sprays lead to the accumulation of electrostatic charge or damage to the exterior of the battery.

## **ANNEX 4.4 - ROOMS AND SPACES FOR UTILITY FACILITIES AFFECTING CONSTRUCTIONS (Pumping stations)**

**(110)** The pumping station providing an extinguishing flow greater than 4.2 l/s shall be separated with fire reaction class **A1 or A2-s1d0** fire resistant elements corresponding to the heat load density ( $q$ ) in adjacent rooms, but minimum **EI/REI 180** for walls and minimum **REI 90** for floors.

**(111)** The pumping station with a flow rate greater than 4.2 l/s may communicate with the rest of the building through a protected functional gap with fire resistant door **EI2 90-C3** or through a protected buffer room, (if it has no direct windows to the outside) and provided with fire resistant doors **EI<sub>2</sub> 45-C3**. Only installations, devices and apparatus specific to this function may be fitted in the room and an external access path (direct door from the outside or from a common traffic ladder) shall be provided.

**(112)** The pumping station with flow less than 4.2 l/s, is separated from the rest of the construction with elements of reaction to fire class **A1 or A2-s1d0**, min **EI/REI 60** for walls and minimum **REI 45** for floors. The station can communicate with the rest of the building through a protected functional gap with a fire resistant **EI<sub>2</sub>30-C3** door without requiring access from the outside (direct

door from the outside or from a common circulation staircase). The station may have access from a hallway/corridor directly connected to an exit to the outside or to an escape stairway with a direct exit to the outside).

#### **ANNEX 4.5 – STORAGE ROOMS**

**(113)** Storage rooms for solid combustible materials and substances with a larger area of 36 m<sup>2</sup> located in constructions for other purposes, must be provided in accordance with the rules:

- a) separations from the rest of the construction, with walls and floors **A1, A2s1d0**, fire resistant corresponding to the density of the heat load and the hazard classes of the stored materials;
- b) the protection of functional communication gaps in separation elements;
- c) smoke evacuation in case of fire.

#### **ANNEX 4.6 - SPECIFIC RENEWABLE ENERGY INSTALLATIONS AND EQUIPMENT**

**(114)** Facades and roofs on which photovoltaic devices are applied shall have:

- a) thermal insulation of the non-combustible facade, regardless of the destination and/or height regime of the building;
- b) non-combustible anchorages and assemblies, regardless of the destination and/or rise of the building;
- c) linkages of equipotential bonding and grounding, according to specialist regulations.
- d) on the roof, the layer to which it is applied:

- the external fire performance set out in Table 2 shall be: Minimum requirements for the classification of the building or fire compartment in the fire stability levels for civil engineering and/or Table 3: Minimum conditions for the classification of the building or fire compartment in the fire stability levels for production and/or storage buildings in the Rules or Table 144: Minimum conditions for the classification of existing buildings with the level of fire stability in **Annex 10** (for existing constructions) for refrigerator systems (Panels/systems of slope roof coverings with additional PV loads)

or

- in the case of arranging the photovoltaic panels over a terrace-type floor, the external component layer of the roofs with the role of ensuring the building's weatherproofness (most often the waterproofing) must meet the external fire performance provided in Table 2: Minimum requirements for the classification of the building or fire compartment in the fire stability levels for civil engineering and/or Table 3: Minimum conditions for the classification of the construction or fire compartment into fire stability levels for production and/or storage buildings **of the Rules** or Table 144: Minimum conditions for classifying existing constructions in the fire stability level of **Annex 10** (for existing constructions) for cladding systems (Panels / cladding systems of sloping roofs with additional loads from PV) according to the classification in fire stability level of construction;

- e) on the facades, the layer to which it is applied must achieve the minimum fire performance **EI 30**.

#### **ANNEX 4.7 - REFRIGERATING AGENTS**

**(115)** According to the series of standards **SR EN 378**, the certified designer shall take into account the classification of refrigerants according to flammability, the maximum permitted quantity of refrigerant according to the occupancy categories. The responsibility regarding the fire safety

compliance measures regarding the refrigerants, in order to adopt them, depending on the classification of the refrigerants and the maximum amount allowed falls on the designer and the investor/beneficiary.

Notes:

- For systems using flammable refrigerants, refrigeration systems must be constructed so that refrigerant leaks do not leak or stagnate, thereby creating a fire or explosion hazard in areas inside the equipment where components and appliances are installed that could constitute a source of ignition and which could work under normal conditions or in the event of a leak, in accordance with **SR EN 378-2**.
- Components and appliances shall not be considered to be a source of ignition provided that they comply with at least one of the requirements set out in **SR EN 378-2**.
- Refrigerants shall be classified into groups according to their influence on safety and health, into occupancy categories according to **SR EN 378-2**.
- Refrigerants shall be assigned according to flammability classification in one of the three groups 1, 2 and 3 based on the lower flammability limit at atmospheric pressure and ambient temperature:
  - group 1 – Refrigerated agents which are not flammable in a vapour state at any concentration in air;
  - group 2 – Refrigerated agents with a lower flammability limit equal to or greater than 3.5 % VA/when mixed with air;
  - group 3 – Refrigerated agents whose lower flammability limit is less than 3.5 % VA/when mixed with air;
- There are three types of locations for refrigeration systems. The appropriate location shall be chosen in accordance with **SR EN 378-2** which takes into account possible risks. These three types of locations are:
  - a) a refrigeration system that stops in a human-occupied space, but which is not a special engine room;
  - b) a refrigerating system with a high pressure part (excluding air-cooled condensers) installed in a special machinery room (see **SR EN 378-3**) or outdoors;
  - c) a refrigeration system with all component parts installed in a special machinery room (see **SR EN 378-3**) or outdoors.
- The maximum quantity of refrigerant in the specific group according to the occupancy category shall comply with the provisions of **SR EN 378-1**.

## **ANNEX 5 – EVACUATION ROUTES FOR USERS IN THE EVENT OF FIRE**

### **ANNEX 5.1 – DOORS**

#### **General information**

**(116)** ‘Door’ means a form of protection of an opening in any wall or in a structure surrounding a fire protected well (excluding such forms of protection called curtains and shutters\*), whether or not the door is constructed from one or more grooves. Doors used for escape, in general, may be:

- doors (normal opening, without closing systems) **on hinges or pivots** compliant **Article 1.2.1 paragraph 90 letter a)** of the Rules;
- doors **equipped with locking systems and exit devices** (anti-panic doors in agreement **SR EN 1125** or emergency exit doors according to **SR EN 179**) compliant with **Article 1.2.1 paragraph 90 letter b)** of the Rules;
- escape doors **sliding** fitted and opening on hinges or pins (sliding doors = doors **with break-out** and doors **redundant automatic sliding doors** compliant with **Article 1.2.1 paragraph 90 letters c) and d)** of the Rules)
  - break-out escape doors are sliding doors which have both sliding motion for automatic opening by means of presence and the possibility of being pivoted by pushing them by the flow of persons in the direction of evacuation. The sliding and pivot panel shall be positioned in such a way that there is no possibility of being placed in an intermediate position and there is the necessary space for pivot opening. It is recommended to use cutting-pivoted doors composed of two coupled panels; or

- redundant sliding exhaust doors used to close wall gaps and intended for the functional circulation and evacuation of users are doors powered by a complete automation system where for each essential component equipment (engine, processor, motion detector, accumulator, etc.) there is a source of electrical power (own batteries, power sets, etc.) in the event of a power failure, defect or fire, the sliding door will open automatically safely without the need for mechanical operation.

Note: Automatic sliding doors may be used on escape routes if they meet the following conditions:

- in the event of a defect, interruption of power supply or fire, the doors shall open automatically and shall remain open; the doors may be opened by pivot, folder or lateral opening (redundant sliding doors only) over the entire standard width to provide the exhaust pass-through units (flows) resulting from the calculation;

- door opening is also ensured manually by pushing in the direction of evacuation outwards or by side opening with an intrinsic mechanical power device;

- **carousel doors (with drum) / revolving doors according to Art. 1.2.1. paragraph 90 letter e) from the Rules**

Note: Carousel doors (revolving) may only be used on the users' escape routes if they are fitted with the possibility of lightly folding door sheets and thereby provides the pass-through units (clear width required to evacuate the streams) resulting from the calculation. Where revolving doors do not meet these requirements, doors with ordinary opening on hinges or pivots shall be provided in their immediate vicinity to ensure the normal escape conditions.

**(117)** The opening of the hinged or pivoted escape doors on the escape routes of more than 30 users capable of self-evacuation must be done in the direction of their movement to the outside (with the exception of the opening of the entrance doors in residential buildings that are not high or very high, where it can be done inwards).

**(118)** By opening, the escape doors must not obstruct each other or reduce the standard free width ("L") of the escape routes of the users.

**(119)** Access doors to enclosed escape stairwells shall be provided with self-closing systems (C), except access doors in accommodation apartments, and all fire resistant or fire-tight and/or smoke tight doors shall be fitted with self-closing systems (C) or, where appropriate, with automatic closing in the event of fire.

**(120)** Access doors to/from spaces fitted with excess pressure shall be equipped with self-closing systems/devices (C), regardless of their fire resistance performance characteristics.

**(121)** The fitting of the ferry, anti-panic bars, etc. on the doors or the angle of opening the doors on the escape path shall not narrow the clear width required to evacuate the exhaust streams resulting from the calculation, in accordance with Variants a and b of the Rules (concerning 'Free escape door widths and heights') and below.

**(122)** Next to escape doors for more than 5 users able to evacuate themselves do not have thresholds above the height of 2.5 cm and those with the highest height are connected by slopes to the floor (slopes with a maximum gradient of 8%).

### **Doors with normal opening on hinges or pivots, used on escape routes**

**(123)** Taps on hinges or pivots that can be used on escape routes (those not equipped with exhaust devices) may be in a groove or in two grooves. Both double door grooves (in two grooves) are considered to be outlet only when the clear width of each of them complies with the results of the standardised tests (on average when the clear width of each groove is greater than or equal to 50 cm width, that can be contradicted by the results of the standardised tests) the exhaust width of

the two grooves being added together. Otherwise, only the larger canteen may be counted for the discharge.

**Doors equipped with locking systems and exit devices (anti-panic doors according to SR EN 1125 or emergency exit doors according to SR EN 179)**

(124) Doors with emergency exit devices may not be fitted in place of doors with panic exit devices, but doors with panic exit devices may be fitted in place of doors with emergency exit devices.

**Doors with panic exit devices - "panic doors"**

(125) Doors fitted with panic exit devices are intended for evacuation from spaces and buildings where a large number of users, who do not know the spaces, can be present at the same time. Examples: crowded rooms, high and very high buildings, as well as those explicitly detailed in the regulatory framework, shopping centres, hospitals, theatres, discotheques, sports functions and catering, etc. The type of building and spaces as well as the number of escape routes and their characteristics shall be taken into account. The provisions of the legislative text for doors fitted with anti-panic bars are mandatory and must comply with the standard. The fitting of such doors refers to panic exit devices complying with the requirements of the European standard **SR EN 1125**.

**Doors with emergency exit devices – “emergency exit doors”**

(126) Doors fitted with emergency exit devices are intended for evacuation from buildings where the public is unlikely to be present in large numbers and where the staff in the building has been trained both in emergency procedures and in the use of specific emergency exit devices fitted. Examples are offices and rooms without crowding and visitors’ access (example to the external evacuation ladder). These are recommended as the lowest level for exit doors where no panic exit devices are required. The fitting of these doors refers to single-drive emergency exit devices complying with the requirements of European standard **SR EN 179**.

**Doors with electrically operated/controlled exhaust systems (for use on escape routes)**

(127) The design of an electrically controlled output system shall be such that any failure of a component included in a single electrical element, such as the trigger, the control element, the electrical locking element, the centrally controlled device, etc.) leads to immediate automatic release of the door.

(128) In premises and buildings where a large number of users who are unaware of the spaces can be present at the same time (e.g. crowded rooms or large numbers of people), the controlled electrical system provided for the evacuation provides solutions in which doors must be fitted with panic exit devices/push bars. The fitting of such doors may relate to exhaust systems with components which also meet the requirements of European standard **SR EN 13637**.

(129) For spaces with fewer users and where not everyone has knowledge of all possibilities for evacuation from buildings and spaces, doors shall be provided with emergency exit devices. The fitting of such doors refers to exhaust systems with components meeting the requirements of European standard **SR EN 179**.

**Sliding doors fitted with hinges**

**Special case: hinged escape doors or pivots capable of being kept open by the electromagnetic or electromechanical device during normal operation**

(130) Electro-magnetic or electromechanical door fixation device - ‘Electromagnetic or electromechanical door fixation device’ refers to a device that holds doors open. This device is designed to automatically close doors in the event of fire, thereby helping to limit the spread of fire and smoke. Triggering events for these devices include smoke detection, door power failure, fire alarm trigger and manual release.

- electromagnetic/mechanical door attachment device – see
- used for doors capable of being kept open by the electromagnetic or electromechanical device during normal operation.

**(131)** Electromagnetic or electromechanical door release device – “Electromagnetic or electromechanical locking device” refers to a device that provides access control by default of the evacuation and holding doors closed. This device is also designed to automatically release doors in the event of fire, thus helping to facilitate evacuation. An electromagnetic/electromechanical release device shall be provided with a means of manual cancellation (release of any other control) located in the discharge space.

*Note:* Must be used with access control during normal operation, with automatic release of door hold-open device in case of fire

**(132)** Doors fitted with panic exit devices shall be compulsorily prevented in the situations provided for in the regulation. Doors fitted with panic exit devices and doors fitted with emergency exit devices may be additionally provided (for theft or other reasons) in accordance with the provisions of Table 128.

## **ANNEX 5.2 – VERTICAL COMMON MOVEMENT (STAIRS)**

### **Straight ramp ladders**

**(133)** The enclosed escape stairway ramps of the above-ground levels shall be separated from the underground ramps in accordance with the provisions laid down in **Article 2.5.6.2.3 paragraphs 1 and 2, Art. 3.2.11.8, Art. 4.1.5.10, Art. 4.2.5.10, Art. 5.5.4, Art. 6.1.5.12, Art. 7.5.6.** and other provisions laid down in the Rules. Except for the situations provided for in **Article 2.5.6.2.3 paragraphs 3 and 4** and the other provisions laid down in the Rules.

**(134)** Underground ramps of enclosed internal stairs placed in the continuation of above-ground ramps shall be separated from ramps corresponding to above ground levels by minimum fire-resistant walls **EI/REI 120** and minimum fire-resistant floors **REI 60**. Functional communication between the underground staircase landings and the above-ground staircase landings of the building is permitted only through a fire door **EI<sub>2</sub> 90-C5S<sub>200</sub>**, located at ground floor level or at the intermediate landing between the basement and the ground floor, opening in the direction of escape. When there is no communication between the underground and aboveground ramps, the exit gap in the ground floor hallway of the underground ramp shall be protected by a fire resistant door of minimum **EI<sub>2</sub> 30-C5S<sub>200</sub>** (unless the standard specifies higher values).

### **Cross ramp ladders**

**(135)** The cross-ramp ladders consist of a combination of two stairs with straight ramps (each), leading to the achievement of two stairways (two separate escape routes).

### **Stairs with spiral ramps**

**(136)** Stairs with spiral ramps with one or more ramps may be curved or spiralled.

**(137)** The characteristic of these helical ladders is the convergence of the edges of the steps at a single point.

**(138)** In the case of stairs with helical ramps, regardless of the ramp width achieved for architectural reasons, only the part of the ramp in which the minimum width of the step is: **18 cm** (i.e. **20 cm** in busy rooms) and the maximum width of **40 cm**.

*(139) A staircase of a mixed shape, composed of helical ramps combined with parts of straight ramps, from the point of view of fire safety, shall be regarded as a staircase with rocking steps.*

*(140) The inclination of the ramps of the escape ladders, the surface and the shape of the steps and floors must allow users to circulate easily and safely, in accordance with the provisions of the applicable technical regulations.*

#### **Stairs with balanced steps**

*(141) Balanced staircases, irrespective of their size, can only be considered as escape routes for a passage unit (flow) for the evacuation of users, when they meet the construction and dimensioning conditions laid down in the standard and the technical regulations specific to staircases.*

*(142) The staircase with balanced steps differs from the other staircases by the different shape of the steps.*

#### **Stairs compliance**

*(143) Depending on the height of the building levels, the ramps of a ladder may be without or with intermediate tips.*

*(144) Stairwells are usually protected by doors or, where appropriate, buffer rooms in tall and very tall buildings. In addition to the standard conditions that these doors must meet, they must also be equipped with self-closing devices.*

*(145) By opening, access doors in stairwells should not reduce the normal width of the stairwells.*

#### **External stairs**

### **ANNEX 5.3 – CORRIDORS**

#### **General information**

*(146) "Corridor" refers to an unobstructed circulation providing a means of escape between rooms or spaces to an exit (final exit to the outside, stairway, overpressure ventilated buffer room, protected clearance, etc.), being a long, narrow room (at least twice as long as wide) along a series of rooms that serves as a passageway and connection to them.*

*(147) Corridors may be internal and external ("cursive") or a combination of the two.*

#### **Circulation and escape space (Escape route)**

*(148) 'Circulation space' (used for escape) refers to unobstructed access between a room and an exit from the building or compartment. Does not include areas used for commercial activities, information or reception desks, areas used for exhibitions, etc.*

*(149) In general, the circulation and evacuation space refers to common vertical (stairs) or horizontal circulations (corridors, hallways, buffer rooms ventilated in overpressure, protected clearances, etc.) evacuation. It is a common area of the route of users from a room to a final exit. Such common areas are separated from other areas by fire-resistant partition walls or equivalent (except as permitted by code).*

*(150) The parking lot is not considered a common evacuation circulation space.*



### **Dead-end corridor**

*(151) Dead-end corridor refers to a situation in a common circulation area/egress corridor where egress to stairs (or directly out) is only possible at one end (to one direction/stairway or to one exit to the outside), without being able to evacuate to the other end.*

## **ANNEX 5.4 – EVACUATION**

### **General information**

*(152) "One-way evacuation" refers to a situation where the occupants of a space have only one route / one direction, from the farthest point (or room door) to an exit or to a split point (as required), to reach several exits.*

*(153) "Two-way evacuation" refers to a situation where users of a space have the opportunity to choose two directions from one point to reach two different exits (doors directly to the outside, protected clearances, overpressure ventilated buffer rooms , stairs).*

*(154) "Evacuation in multiple directions" refers to a situation where users of a space have the possibility to choose multiple directions from a point to reach different exits (doors directly to the outside, stairs, protected clearances, ventilated buffer rooms in overpressure, etc.). In this case, the shortest direction is considered (only one of the lengths of the escape path must meet the standard conditions) when the evacuation is in several different directions, at least two of which must be opposite (at an angle of at least 90°), from the farthest place considered, to the door of the staircase, of the protected clearance or of the buffer room protected from access to the nearest escape ladder or to a door/exit directly outside.*

*(155) Evacuation from a fire compartment through spaces belonging to another fire compartment may take place only if the movement cannot be blocked by flames or smoke.*

*(156) In buildings, fire compartments or parts of buildings which are independent from the point of view of circulation, persons shall typically have access to at least one escape path, the second escape route (when required) shall, as far as practicable, lead in opposite directions and may belong to another fire compartment.*

*(157) Escape routes shall not lead outwards through places where circulation can be blocked in the event of fire due to flames, smoke, thermal radiation, etc.*

### **Length of escape route**

*(158) The length of the escape route for users of buildings shall be determined on the route to be followed in the axis of escape routes from the user's starting point to the nearest escape door (direct to the outside, access to an escape staircase or access to a protected landing) or the first step of an open staircase, taking into account the position of the various equipment or fixed objects to be agaped. The steering changes in the route shall be made at angles with degrees depending on the axis of the escape routes.*

### **Corridors**

*(159) Clearances on escape routes shall be measured horizontally in the centreline of the circulation and escape routes and in the shortest direction, as appropriate, from the door of the room or space (where within rooms/spaces the length of the escape route is less than the length of the enclosed corridor specific to each function or type of construction) to the door of the stairway, protected landing or access buffer to the nearest escape stairway or direct door to the outside.*

## **Open space**

**(160)** The distances on escape routes shall be measured horizontally in the axis of the traffic and escape routes and in the shortest direction, as appropriate, from the furthest place in a room or space (when within the rooms/spaces the length of the escape track is greater than the length of the flooded corridor specific to each function or construction type), the door of the stairway, protected clearance or access buffer room to the nearest escape ladder or direct door outdoors.

## **Particular case – corridors with evacuation in ‘Y’**

**(161)** The length measured to an access staircase in two different directions, located in different directions, shall be considered a permissible escape route if the total distance of each length to a staircase door does not exceed the standard length in two directions.

**(162)** A flooded corridor less than the normal length for each operation/building type, measured from an escape path with access to two stairways, buffer rooms, protected release rooms or exits in opposite directions, shall be considered as permissible escape if the total distance to a ladder, buffer room, protected release or outdoor exit does not exceed the length of escape in two directions.

## **Length of escape route**

**(163)** The length of the escape route (‘escape distance’) refers to the distance needed to be travelled from the furthest point in any chamber or space (except those explicitly stipulated in the regulation) or from the doors of cameras or spaces (where the length of evacuation from their interior is less than the length of the capped corridor for each individual operation or high or very high type of construction) to the edge of the door aperture, directly at:

- a closed exhaust staircase or a protected buffer room (ventilated over pressure) of an exhaust stairway, or
- an external staircase, or
- protected clearance, tunnel, or
- directly to the outside, or
- up to the first step of the open stairway

unless otherwise permitted under these Rules (as in the case of exits to refuge areas)

**(164)** The measurement starts at **40 cm** from the inside of the wall where the ‘furthest place/point’ or ‘starting point’ of any room/room or space is specified.

**(165)** Within rooms where necessary, the length measured to an outlet with access in two different directions, located in opposite directions, shall be considered as the permissible escape path if the total distance of each length to a door does not exceed the normal length in one direction and the angle formed between the two directions must be greater than or equal to 90° degrees.

## **Evacuation to existing buildings**

**(166)** Provisions may also apply to existing buildings **Article 2.5.14.1.** of the Rules.

## **Escape length**

**(167)** ‘Escape length’ means the actual distance to be travelled by a person from any point of a camera floor area (or from its door when the length of discharge of a capped corridor is not exceeded within the room) to the relevant exit (ladder, buffer room, protected clearance, tunnel, direct outlet), taking into account the arrangement of walls, partitions, intermediate doors and fixed locations specific to the facility.

**(168)** The length of the escape path of construction users shall be determined on the route to be travelled - **in the centre of the escape routes**, from the point of departure of the user to the nearest

evacuation door (direct outside, access to an evacuation ladder, buffer or access room in a protected clearance), or the first step of the open stairway, taking into account the position of different equipment or objects with fixed location or furniture and which must be bypassed in accordance with **sub-chapter 2.5.14. Length of escape path** (from the Rules).

## **ANNEX 5.5 – SPECIAL REQUIREMENTS FOR THE EVACUATION OF PERSONS WITH DISABILITIES**

### **Terminology**

**(169)** The following terminology shall be used, in accordance with Law No 448 of 6 December 2006 on the protection and promotion of the rights of persons with disabilities and ‘Rules on the adaptation of civil buildings and urban space to the individual needs of persons with disabilities, reference number NP 051 2012 Revision NP 051/2000’:

**Routes and means of access** - elements ensuring access to public buildings and enabling persons with disabilities to move inside the building;

**Public utility buildings** - buildings belonging to public and private institutions offering different types of services to the population;

### **General provisions**

**(170)** Public utility buildings, access roads, residential buildings, public transport stations, platforms of the main railway transport stations, parking areas and the other functions/destinations provided for by Law No 448 shall be adapted in accordance with the relevant legal provisions, so as to allow unhindered access for persons with disabilities and their evacuation.

**(171)** Heritage and historical buildings (historical monuments) shall be adapted in accordance with architectural characteristics, in accordance with the relevant legal provisions.

**(172)** The following buildings/functions are exempted from the standardized means (lifts or stairwell staging points) of egress for persons with disabilities:

(1) certain production buildings/production functions that are exempted from the respect of accessibility for persons with disabilities, in line with the regulatory requirements for accessibility in the built environment;

(2) ground floor buildings with or without subsurface/low water levels (subsoil/middle floor without permanent work activities, where no lifts or parking points are foreseen in the staircase, but other standardised evacuation arrangements such as ramps are provided on the ground floor).

**(173)** Buildings with medical use (hospitals, health care institutions, etc.) are mandatory with evacuation lifts for persons with disabilities.

**(174)** Escape routes must be free of any obstacles that may cause undue delay during the evacuation of disabled persons, e.g. high thresholds or steps.

**(175)** Stairways with less than 3 steps are prohibited in accordance with the provisions of **NP 063** in conjunction with **Art. 2.5.6.1.1. paragraph 3** of the Rules.

### **General requirements for parking points for disabled persons**

**(176)** A parking point for disabled persons shall be provided on all floors, including all levels of the subsoil (except the technical subsoil), except the ground floor, in order for disabled persons to wait safely for evacuation assistance.

*(177) It is recommended that there be at least two disabled parking spaces on each floor of a building/fire compartment, except in a building/compartment designed with a single escape stair permitted under these Rules. The corridor that is the escape route for people with disabilities (with wheelchairs) should have a minimum clear width of 1.20 m (1.30 m in sanitary buildings) and comply with the technical regulations in force. It is recommended that the minimum width of manoeuvring and waiting pockets should also be provided **1.80 m** and min. **2.00 m**. If these are not foreseen, consideration shall be given to **Article 2.4.4.3.3.** of the legislation.*

### **Special requirements for the evacuation of disabled persons from stationary points**

*(178) The parking point of persons with disabilities shall be located and kept during operation without hindrance and may be located in the following locations/areas:*

- a) The overpressure ventilated buffer room of the lift provided for the transport of people with wheelchairs or people with disabilities that can be used and for their assisted evacuation in case of fire;*
- b) The overpressure ventilated buffer room of the emergency lift (firemen);*
- c) In a corridor equipped with smoke and hot gas exhaust systems or overpressure ventilated, in a protected clearance or in an external corridor, in a waiting manoeuvre pocket so as not to reduce the exit gauge of the corridor/clearance protected;*
- d) In the enclosure of a ventilated buffer room under excess pressure if it does not reduce its exhaust gauge;*
- e) In the enclosure of an escape staircase if it does not reduce its escape clearance.*

*(179) The parking point of disabled persons located within the enclosure of an escape staircase shall be positioned away from the edge of the first step of the escape staircase and in all cases shall not influence the normalised width resulting from the calculation of the persons' escape path.*

*(180) The parking point of disabled persons situated in any area permitted under paragraph 140 letters a), b), c), d) shall not be reduced/penetrated into the dimensions/spaces required for evacuation for the abovementioned areas.*

*(181) If there is a parking point for disabled persons, a marking with "Parking point for disabled persons"/"Place of refuge for disabled persons") must be displayed prominently*

*(182) A means of communication/alarm shall be provided for disabled persons to call for assistance in the event of a fire emergency. The means of communication shall:*

- a. be located between **80 cm** and **1.20 m** above the final floor level;*
- b. be appropriately labelled;*
- c. with a clearly visible indication of the operation; and*
- d. generate a clear visual indication to indicate that the distress signal has been transmitted.*

### **Additional requirements for parking points for disabled persons**

*(183) A parking point for disabled persons shall be suitably dimensioned so that it can provide space to a wheelchair user and allow the user to easily handle the wheelchair.*

*(184) The parking point of disabled persons shall meet all of the following requirements:*

- a. the space provided for a wheelchair at a parking point of disabled persons shall be at least **1,50 m X 1,50 m** to enable wheelchair handling;*
- b. where a parking point for disabled persons is located within a protected escape ladder, a buffer room with excess pressure or a ventilated buffer room over pressure of the intervention lift or lift intended for the transport of persons with trolley or disabled*

persons who may also be used for their assisted evacuation in the event of fire, the wheelchair space shall not reduce the resulting dimensions by the calculation required for the evacuation or intervention of such spaces and the access of persons to the wheelchair shall not obstruct the exhaust flow; and

c. the parking point of disabled persons should be marked on the ground with a wheelchair symbol in white on a contrasting background with a visible rectangular outline (usually white) dotted.

**(185)** A parking point for disabled persons shall be closed by a fire-resistant construction as prescribed (fire resistant walls and floors of stairways, corridors ventilated over pressure, buffer rooms ventilated under excess pressure, or other rooms ventilated over pressure, except for external walls of a building which only need to meet its own standard conditions) and shall be served directly by an escape path to an outlet from the floor, ladder, lift also used for evacuation or final outlet to the ground floor.

**(186)** Handrails in the inside eye of a protected escape ladder shall be continuous.

**(187)** A dedicated lift for wheelchair users (intended for the transport of persons by trolley or disabled persons that can also be used for their assisted evacuation in the event of fire), where installed, shall be placed as prescribed. Such a lift, when in the operating position, must not shrink the standard dimensions of the escape route for users of the building.

**(188)** Internal and external exit ramps may be used as exits in place of internal and external escape staircases or lifts also used for the evacuation of disabled persons if they comply with specific regulations and the internal ramps have equivalent performance.

#### **Refuge area – general case**

**(189)** Parking points for persons with disabilities may be located in the enclosure:

- staircases
- protected buffer traps
- protected decks
- corridors/fencing protected against smoke
- common circulations of an adjacent compartment with which they communicate

Note: The construction of parking places for people with disabilities should not narrow the standard width of the escape route. Each parking point will have to provide the dimensions of **1.50 m x 1.50 m**.

**(190)** The area of refuge (where no parking points for disabled persons are provided for in existing buildings except for the health function) may be:

- a room inside a building (within the same fire compartment), or
- an area inside another building belonging to the same fire compartment, or
- an area (determined as separate room or not) within an adjacent separate fire compartment.

**(191)** “Refuge area” means an area where evacuated persons can temporarily refuge, through an interior corridor (protected or not) or outside corridor or by a buffer room (whether or not protected).

**(192)** When evacuation to the refuge area takes place in one direction, the following conditions are required:

- the refuge area has a lift for the evacuation of disabled people,
- there is a dedicated refuge room with the following characteristics: walls **EI180**, door **EI90-C5S<sub>200</sub>**.

*It should be positioned so that it is as close as possible to the stairwell.*

- the room dedicated to the refuge must be accessible from the outside through a window with the possibility of access for rescue teams to rescue people from a height,*
- the number of beds established shall be calculated taking into account 2/3 (two thirds) of the total number of beds and an area of **1m x 2m** shall be allocated for each bed.*

### **Lifts provided for disabled persons**

**(193)** *In order to meet the needs of people with disabilities, lifts used also for their evacuation must be designed (in non-medical buildings) as follows:*

- the minimum dimensions of the accessible lift cab used for a wheelchair user, with the accompanying person or for a person using other aids to move and has an accompanying person are **1,10 m x 1,40 m**, a free opening of the door of min. **90 cm** is recommended. The door shall be positioned on the narrow side of the cab.*
- the minimum dimensions of the accessible lift cabin used for two wheelchair user persons shall be **1,10 m x 2,10 m**, a free opening of the door of min. **90 cm** is recommended. The door shall be positioned on the guest side of the cab.*

**(194)** *If the lift car has two doors on adjacent walls, the minimum size of the car used for a wheelchair user is **1.60 m x 1.40 m** with a clear door opening of **1.10 m**.*

## **ANNEX 6 – ACCESS, INTERVENTION AND RESCUE ROUTES IN THE EVENT OF FIRE**

### **ANNEX 6.1 – TRAFFIC ROUTES**

**(195)** *Roadways passing over underground constructions (basements, canals, tunnels, etc.) or through above-ground constructions shall correspond to heavy traffic conditions and shall be dimensioned to ensure:*

- mass in tonnes to be borne by the road on a deck:
  - front: **15 t** (2 decks) and rear: **34 t** (3 decks)**
- total thrust of the hold on the road: stalling takes place in **4** points (the area of a hold is **0.8 m**)<sup>2</sup>*

**(196)** *The carriageways or platforms on which emergency vehicles or high-altitude rescue vehicles may travel may be designed with a capacity as in the previous paragraph. For the possibility of lowering ladders larger than these, their specifications shall be complied with, in accordance with the technical data of the high-altitude rescue vehicle.*

**(197)** *The carriageway should be wider where turning manoeuvres are carried out (according to the relevant regulations). Unless otherwise specified, the radius of the places where the return manoeuvres are carried out shall be deemed to be: **11 m**.*

**(198)** *The section connecting the driveway to a public road area shall be widened as necessary for all directions of travel.*

### **ANNEX 6.2 - PERIMETER OF EXTERNAL WALLS**

**(199)** *Building plan ABCDEFGHIJKLMNOP (as per Figure 225) where AP and KL are walls in common with other buildings (or fire compartments). The footprint of the building is the maximum perimeter of the plane obtained by the vertical (horizontal) projection of any point defining a console floor (i.e. the contour defined by ABCDEFGHIJKLMNOP points). The perimeter of the*

building for the purposes of the standard is the sum of the lengths of the exterior walls, taking into account the footprint of the cantilevered floors, i.e. (A to B to C to D to E to F to G to H to I to J to K) + (L to M to N to O to P).

**(200)** ABCDEFGHIJKLMNOA building plan (according to Figure 226) where KL is the wall in common with another building (or fire compartments). The footprint of the building is the maximum perimeter of the plane obtained by the vertical (horizontal) projection of any point defining a console floor (i.e. the contour defined by ABCDEFGHIJKLMNOA points). The perimeter of the building for the purposes of the standard is the sum of the lengths of the exterior walls, taking into account the footprint of the cantilevered floors, i.e. (A to B to C to D to E to F to G to H to I to J to K) + (L to M to N to O to P to A).

**(201)** Building plan ABCDEFGHIJMNOA (as shown in Figure 227) and has no walls in common with other buildings (or fire compartments). The footprint of the building is the maximum perimeter of the plane obtained by the vertical (horizontal) projection of any point defining a cantilevered storey (i.e. the contour defined by points ABCDEFGHIJMNOA). The perimeter of the building for the purposes of the standard is the sum of the lengths of the exterior walls, taking into account the footprint of the cantilevered storeys, i.e. (A to B to C to D to E to F to G to H to I to J to M to N to O to P to A).

## **ANNEX 7 - FUNCTION-SPECIFIC PERFORMANCE OF CONSTRUCTION WORKS**

### **ANNEX 7.1 - CIVIL BUILDINGS OF ORDINARY HEIGHTS BUILDINGS FOR HEALTH**

**General (at health functions: hospitals, polyclinics, dispensaries, crèches, children's homes, homes for the elderly and disabled, sanatoriums, etc.)**

**(202)** "Hospital" is a building used for medical and surgical care and must include continuous (24-hour) service healthcare functions, such buildings include, but are not limited to, the following:

- a) General hospitals (university, emergency, regional, etc.);
- b) Psychiatric hospitals (mental health institute);
- c) Hospitals for children (children and parents); and
- d) Community hospitals (semi-regional).

(A hospital is a publicly-owned or privately-owned health care facility with beds, of public utility, with legal personality, providing medical services. The medical services provided by the hospital are: preventive, curative, rehabilitative and palliative, pregnancy and maternity care, newborn care, etc.).

**(203)** "Nursing facility" refers to a building or part of a building used for the shelter and continuous medical care of persons (24 hours a day) who, because of physical incapacity, are unable to care for their own needs and safety without assisted (other persons') assistance. These functions provide inpatient medical care and include the following:

- a) Asylums;
- b) Nursing homes and homes for the aged and disabled; and
- c) Hospices;
- d) Other similar

**(204)** "Ambulatory care facility" is a building or part thereof used for outpatient medical services for the treatment of patients, patients unable to make arrangements for self-care or safety under emergency conditions, with no possibility of self-evacuation (without assisted care). These functions include the following:

- Day clinics for renal dialysis;
- Aesthetic clinics and other surgical clinics requiring general anaesthesia;

- Non-mental rehabilitation day clinics;
- Endoscopy clinics.
- Other similar

**(205)** "Assisted care facility" is a building or part of a building, without rooming-in accommodation (overnight), used by persons who, because of age or physical or mental disability, are unable to maintain their own safety. Such functions shall include the following:

A. (Pre-)Pre-school (children's homes - for pre-school children, e.g. crèches, day care centres, etc.); -

B. Day-care centres:

- Day care centres for the elderly;
- Day centres for people with mental disabilities;
- Day care homes for persons with intellectual disabilities;
- Day centres for mental/psychiatric rehabilitation and
- Children's homes – for children of school age
- Other similar

### **Sanitary operation – horizontal and vertical movement**

**(206)** In above-ground health care buildings of normal heights where evacuation of users in the event of fire must be carried out by stretcher or trolley, the clear widths of the functional circulation and escape stairways shall be a minimum of **1.40 m** for stairways and inclined landings with landings / bridges of **2.20 m** deep (1 stretcher evacuation flow where less than **120** beds are provided in the fire compartment) or a minimum of **2.20 m** for stairways and inclined landings provided with landings/bridges **2.60 m** deep (2 stretcher evacuation flows where **120** beds or more are provided in the fire compartment).

**(207)** The minimum clear passage height through common escape routes (corridors, hallways, buffer rooms, protected decks, stairways, escape tunnels, etc.) through which persons are evacuated by stretcher shall be: **h = min. 2.20 m** and stairways, regardless of clear width, shall have a handrail on both sides (fixed to the parapet, handrail or wall).

**(208)** As an alternative to the above provisions, for ramps, landings, staircases and inclined landings, where evacuation of users in the event of fire must be carried out by stretcher or trolley, the following alternative values set out in Table 129 may be adopted and may be applied in individual cases, provided that they are justified in the design:

**(209)** The number of lifts for the evacuation of people with disabilities is calculated according to the medical structure and the number of beds, considering **1 lift per 120 beds** (provided that any fire compartment with hospitalisation function, regardless of its capacity, is equipped with at least **2** user lifts, of which at least one must be compliant for people with disabilities).

**(210)** Lifts for evacuation of disabled persons shall be as follows:

(a) the dimensions of the cab shall be:

- i. for evacuation with **2** stretchers:
  - i) min. **2.20 m** width;
  - ii) min. **2.70 m** depth;
- ii. for evacuation with **1** stretcher:
  - i) min. **1.80 m** width;
  - ii) min. **2.70 m** depth;

b) the dimensions of cabin doors shall be:

- i) min. **1.40 m** clear width;
- ii) min. **2.05 m** clear height;

c) the doors of the cab shall be sliding with opening - automatic closing;



d) the dimensions of the escape platform in front of the lift shall be:

i) min. **2.50 m x 3.30 m** - grouping on one front;

ii) min. **2.50 m x 5.40 m** - grouping on two fronts (advisable **3.00 m x 5.40 m**);

(211) Inside the fire compartments with hospitalization function, the following values will be used for the dimensioning of the escape routes:

a) the clear width of the main corridors in care, diagnosis and treatment facilities shall be:

i) min. **2.20 m** for stretcher evacuation:

ii) min. **2.40 m** for roller bed evacuation;

b) the clear width of protected corridors with waiting (refuge) areas along the walls shall be:

i) min. **2.40 m** waiting on one side;

ii) min. **3.50 m** waiting on two sides;

c) clear width for the movement with the stretcher:

i) min. **1.80 m** turning at right angle;

ii) min. **2.20 m** space for manoeuvre.

### **Refuge area in health buildings**

#### **General provisions**

(212) The area of refuge in health buildings may be:.

- an area inside a building (within the same fire compartment), or

- an area inside another building belonging to the same fire compartment, or

- an area (determined as separate room or not) within an adjacent separate fire compartment.

(213) When evacuation to the refuge area takes place **in one sense** the following conditions are required:

- the refuge area has a lift for the evacuation of disabled people,

- there is a dedicated refuge room with the following characteristics: walls **EI180**, door **EI90-C5S<sub>200</sub>**.

It should be positioned so that it is as close as possible to the stairwell.

- the room dedicated to the refuge must be accessible from the outside through a window with the possibility of access for rescue teams to rescue people from a height,

- the number of beds determined shall be calculated taking into account **2/3** (two thirds) of the total number of beds in the refuge area, and for each bed an area of **1 m x 2 m**.

#### **'Refuge area' located in the same fire compartment**

(214) If the "refuge area" is located in **the same fire compartment** with the health function and is connected by a **closed or open (external) corridor**, instead of the requirement for the standard provision of simultaneity of the health building serving as refuge area regarding escape routes, the number of users for whom evacuation conditions are ensured in case of fire is determined.

(215) In this sense, the sum of the capacities of the two is taken into account, i.e. the maximum simultaneous user capacity added up, using the occupancy factors presented for users coming from the evacuated area as well as 100% of those coming from the non-transmuted refuge area.

(216) The horizontal and vertical escape routes of the building (or part of the building) serving as a refuge area must be complied with in this respect (in terms of the regulatory capacities required for evacuation).

*(217) Also, the standard length of the escape routes must be respected, represented by the length travelled from the point of departure from the area where evacuation is required, to the portion of the building that serves as a refuge area, to the entrance to the evacuation stairs (respectively of the rooms their buffers, if they are provided) or directly outside, of the portion of the building that serves as a refuge area.*

*(218) This area of temporary refuge must be adequately separated from the rest of the health building in which it is located or the adjacent health building by fire-resistant construction (minimum partition walls with rated fire performance and doors in fire walls sectorization with standardized fire performance or the most restrictive other conditions generated by the density of the thermal load or the risk from the adjacent rooms) and connected by an external corridor (or a circulation path open to the outside).*

*(219) The refuge area as well as the **closed or open (exterior)** access corridor must always be practicable and accessible. In this sense, if the temporary refuge is also done in corridors (in existing buildings), they must be equipped with smoke and hot gas (or overpressure) exhaust systems, and their standard dimensions necessary for evacuation must not be reduced by the temporary placement of evacuees from the adjacent building portion.*

#### ***'Refuge area' located inside another fire compartment***

*(220) Where the 'refuge area' is located **inside another fire compartment** with a health function, it must be connected by an external open corridor or a closed corridor equipped with overpressure or smoke and gas evacuation systems hot (among them, at the border of the fire compartments, a buffer room provided with overpressure is mandatory) between the two areas (the area to be evacuated belonging to one fire compartment and the refuge area belonging to another fire compartment).*

*(221) Where the 'refuge area' is located in another fire compartment with health operation, the total amount of the vehicle shall be ensured in order to determine the number of users for whom the evacuation conditions in the event of fire are ensured.*

*(222) In this sense, the actual sum of the capacities of the two is taken into account, namely the maximum simultaneous user capacity added up, meaning **100%** of the users who come from the area of refuge as well as **100%** of those who come from the area from which they are taking refuge.*

*(223) The horizontal and vertical escape routes of the compartment serving as a refuge area shall be complied within this respect (in terms of the regulatory capabilities required for evacuation).*

*(224) The standard length of escape routes must also be respected, represented by the length travelled from the point of departure from the area where evacuation is required, to the separate compartment that serves as a refuge area, to the entrance to the evacuation stairs (respectively the buffer rooms of them, if they are provided) or directly outside, of the separate compartment that serves as a refuge area.*

*(225) This temporary refuge area belonging to a fire compartment with a health function must be adequately separated from the area from which evacuation is required (belonging to another fire compartment), by fire walls and necessarily with a buffer room ventilated in overpressure provided with doors with standardized fire performances or the most restrictive ones generated by other conditions of the adjoining rooms) between an open external corridor or a closed corridor equipped with overpressure or smoke and hot gas exhaust systems between the two compartments.*

*(226) The refuge area as well as the external or internal corridor and the access buffer room must always be practicable and accessible.*

*(227) For this purpose, if the temporary refuge is also carried out on corridors (at existing constructions), they shall be provided with smoke and hot gas (or excess pressure) evacuation systems and their normal clearance necessary for evacuation shall not be reduced by the temporary location of evacuations from the adjacent fire compartment (with health operation).*

**General remark 1:**

*The standard length of escape routes must be respected, represented by the length travelled from the exit door of the room that serves as a refuge area, as well as the length travelled from the point of departure from the area where evacuation is required, to the nearest door provided to the escape stairs that are taken into account for this aspect (respectively of their buffer rooms, if they are provided or of the protected clearance to the stairs) or directly to the outside.*

*Regardless of the positioning of these areas (where evacuation is required as well as the refuge area) and horizontal and/or vertical escape routes usable within the same fire compartment, or of two or more fire compartments, the distance travelled is taken into account from the farthest point in the area where evacuation is required to the nearest of the evacuation stairs located in the refuge area. Similarly, on the ground floor, the same condition must be met, taking into account the distance travelled from the farthest point in the area where evacuation is required to the nearest door with access to the outside located in the refuge area.*

**General remark 2:**

*If the two areas (the area from which evacuation is required and the refuge area) are located in different fire compartments (both with a health function), one of the compartments (or certain spaces located in it) can become the area of refuge for the second (or any other) fire compartment.*

*In the event that two fire compartments with a health function become reversibly refuge areas (one for the other), it is mandatory that the escape routes are completely distinct (no overlapping evacuation in both directions), at least until the first intersection with a horizontal escape route (with two-way escape), provided in the refuge area.*

*(228) For evacuation to the refuge area, the following occupancy factors may be used to comply with it:*

- health operation with stretcher evacuation or roller bed outpatient care  
**2 m<sup>2</sup>/person,***
- other functions with **assisted** evacuation or wheelchair evacuation of disabled people: **1 m<sup>2</sup>/person***

***Note:** The refuge area in buildings with a health function is a TEMPORARY use/exploitation area, intended EXCLUSIVELY for people with disabilities. Therefore, the evacuation routes must be designed to be able to receive / evacuate all the people who will occupy the refuge area (i.e. the number of beds established is calculated taking into account two thirds of the total number of beds in the evacuated area, and for each bed an area of **1m x 2m** must be allocated) in case of emergency and a lift must be provided in the refuge area to evacuate disabled people (with stretcher or wheel bed). The designed refuge area can also be represented by existing spaces, rooms that meet the standard conditions (**EI180** walls and **EI90-C5S<sub>200</sub>** door), with free spaces that can temporarily receive the number of people evacuated from the evacuated portion, the total summation of the number of persons in a temporary situation not having to meet the standard conditions.*

*(229) Refuge areas shall have at least two distinct and independent escape routes (except those to other areas of refuge), directly to the outside (or via the escape stairs directly to the outside, if these areas are not located on the ground floor) in conditions where all zones are in the same fire compartment.*

## **ANNEX 7.2 – CAR PARKS**

### **Open parking (above ground)**

*(230) The above-ground parking lots can be:*

**Above-ground open parking** - open construction that has permanently open gaps on at least 50% of the surface of the external walls intended for housing motor vehicles and their trailers (in which no repair work is carried out).

In the above-ground open parking spaces, the smoke and hot gas exhaust holes arranged in the outer walls are taken into account only for a maximum depth of **30 m**, in which case they are considered to have ensured the conditions for smoke and hot gas exhaust. If the smoke exhaust holes arranged in the external walls do not meet the requirement mentioned above, then it is necessary to exhaust the smoke and hot gases from the above-ground open parking lots according to the provisions of the **NP 127** standard.

**Strong naturally ventilated above-ground parking** - a distinct category of open above-ground parking with one or more free perimeter levels (open to the outside) and which simultaneously fulfils the conditions provided for in **Art. 1.2.1** of the standard, definition no. 57), thus:

i. - on each parking level, the free surfaces in side walls open outwards shall be located on at least two opposite façades and each represent a minimum of **50%** of the total surface of the open façade, the height taken into account being the free distance between the finished floor and the roof;

ii. — the distance between the opposite free façades, open outwards, shall not exceed **75.00 m**;

iii. - the free perimeter areas, open to the outside, on each parking level are the standard percentage of the usable parking space area of that level; areas of enclosed spaces intended for horizontal and vertical pedestrian movements and other destinations (functional annexes, related activities, etc.) shall not be taken into account;

- The sum of the total areas of open gaps  $\geq$  the normalised percentage of the parking level floor area.

- Parking level floor area\*

\* - areas of enclosed spaces intended for horizontal and vertical pedestrian circulation, functional annexes, related activities are not taken into account;

- the areas of load-bearing (pillars, diaphragms) and non-load-bearing (perimeter enclosures, partition walls) construction elements are not taken into account.

- Outdoor open space area (or light courtyard)  $>$  Sum of open vertical surfaces

- The areas of outdoor spaces (or light courtyards are greater than or at least equal to the sum of the areas of openings in the exterior walls).

- Sum of open surfaces in external walls  $\geq$  **50%** of the total area of the open façade ( $h_x \times d_1 + h_x \times d_2 + h_x \times d_2 + h_x \times d_2 \dots$  etc.).

- the open outer space shall have the horizontal area at least equal to the sum of the perimeter adjacent free surfaces. Naturally ventilated above ground car parks are considered to have smoke and hot gas exhaust.

### **Electric car charging stations**

**(231)** As a rule, it is necessary to provide fire-resistant floor-to-floor walls/ partitions (with the same fire resistance as the parking structure) grouped in bundles of maximum 3 parking spaces on the long and short sides between parking spaces containing electric car charging stations (for **45°**, **60°**, **75°** or **90°** parking). If this is not possible, provision shall be made for alternative means to limit the spread of the fire to neighbouring vehicles. It is not recommended to position loading stations in such a way that loading is done longitudinally to the roadway. The same measures shall be provided for the charging stations of motorcycles and bicycles, taking into account the dimensions of **1.00 m x 2.60 m** (for parking on **90°**).

*(232) The positioning of weather water drains shall not interrupt the fire resistance of the floors. Plastic pipes for sewerage shall be provided with self-closing, minimum **EI** fire resistant shut-off systems with the same value as the standard fire resistance of the floors. Clearances around all ducts, cables, electrical conductors (regardless of size), etc., including those installed in ducts, shall be enclosed with materials having the same fire resistance as the floors they intersect (minimum floor fire resistance as specified in Table 2: Minimum requirements for the classification of the building or fire compartment into fire stability levels for civil construction and Table 3: Minimum requirements for the classification of the building or fire compartment into fire stability levels for production and/or storage buildings).*

*(233) As a rule, it is necessary to provide fire-resistant walls (floor-to-floor partitions) with the same fire resistance as the structure of the parking structure, grouped in bundles of a maximum of 3 parking spaces on the long and short sides between parking spaces containing electric car charging stations.*

### **ANNEX 7.3 – ARENAS AND STADIUMS**

*(234) The width of the functional circulation and evacuation routes for users in the stands, the evacuation staircases, and the circulation between sectors (parallel and perpendicular to the stands) shall be determined in accordance with **Art. 3.3.2.11**.*

*(235) The distance from each place down to an evacuation outlet in a safe space, land level access or road circulation shall be:*

- max **45,00 m** – for fire stability level **I** or **II**;*
- max **35,00 m** – for fire stability level **III**;*
- max **25,00 m** – for fire stability level **IV**;*
- max **15,00 m** – for fire stability level **V**.*

*(236) The seats (benches) must be fixed (fixed to the supporting structure).*

*(237) Access to the grandstands can be made by partially or fully combining the following three systems:*

- a) laterally or behind the grandstand;*
- b) from the front (in this case the first step shall be raised approximately **1.00 m** above the sports field);*
- c) with the vomiters (accesses in the upper-back part of the stages are recommended, opening in favour of adequate distribution circulation, the vomiters presenting the disadvantage of generating ambushes in case of emergency evacuation).*

*(238) The number of entries in the galleries is determined by the number of spectators and escape routes respectively, and by the need for controllers (which must be as low as possible).*

*(239) The maximum travel distance between a seat in the grandstand and the nearest exit (grandstand evacuation being the leaving of the grandstand seats by all spectators and their passage through the "grandstand access points" to the outer enclosure of the grandstand) must be **45.00 m** (for fire stability level **I** or **II**, for other stability level classifications the values in **Art. 3.3.2.9**. will be used).*

*(240) The dimensions of the access and escape routes in the stands shall comply with **Art. 3.3.2.10**.*

**(241)** For access, circulation and evacuation of users from the steps, the steps shall have equal widths (minimum **1.20 m** for evacuation of up to **200** users and minimum **1.60 m** for evacuation of more than **200** users) and depths.

**(242)** The size of the elements making up the grandstand must comply with the data resulting from the study of the visibility curve, resulting in either a straight profile of the grandstands or a parabolic one. Where the cross-section of the gradient is a parabolic curve, the following conventional elements shall be taken into account:

- the first step will have approx. **18 cm** high and the last one maximum **40 cm**;
- in front of the first step a circulation and evacuation space of at least **1.20 m** shall be reserved;
- the width of the graduation according to the type of seat, with/without backrest shall be minimum **75 cm** and not more than **85 cm**;
- the height of the step results from the calculation of the visibility curve (implicit in the steps provided on perpendicular circulations on usable steps and for evacuation).

**(243)** The dimensions of the steps, i.e. height (**h**) and depth (**l**), result from the calculation of the visibility curve, their maximum and minimum values depending on the type of step (standing or seated) as follows:

- a) Standing steps: maximum **h = 20 cm** and minimum **w ≥ 35 cm** (recommended **40 cm**);
- b) Steps with seating (with seating located directly on the step); **h max = 40 cm** and **L minimum = 70 cm** (recommended **80 cm**). In the case of their location by fixing them to the steps or in the case of individual seats, the minimum standard distance between rows (greater than or equal to **35 cm**) and their characteristics shall be taken into account.

**(244)** Seating on the steps can be on benches or individual chairs, whose minimum dimensions, i.e. depth (**l<sub>b</sub>** for benches and **l<sub>s</sub>** for chairs) and width (**L**) are as follows:

- bench seating: **l<sub>b</sub> ≥ 30 cm**, **l<sub>t</sub>** (minimum width of crossing between rows) **≥ 35 cm** and **l<sub>step</sub>** (step) **≥ 65 cm**;
- seats on individual seats (side-bounded seats with or without arms and backrest): **L ≥ 50 cm** (distance between the lateral boundaries of the seat), **l<sub>s</sub> ≥ 35 cm** (recommended **40 cm**) and **l<sub>t</sub> ≥ 35 cm** (minimum foot width) recommended **≥ 40 cm**. If the seat back is more than **30 cm** high, then the minimum width of the footrest shall be **40 cm**.

**(245)** Seating rows on individual seats shall be so dimensioned as to leave a minimum clear width (footrest width) of **35 cm** with the seats in the seated position. Where seats are foldable, the minimum width of passage between seats (seats with the bench seat raised) is recommended to be **50 cm**. The bench shall be placed in the console, so that the front edge moves forward by **20-30 cm** in relation to the vertical wall of the graduation on which it is placed.

**(246)** The free distance between rows of seats shall be at least **35 cm**.

**(247)** Perpendicular movements for more than **15** steps having a slope greater than **25°**, provision shall be made for user support points.

**(248)** In open stadiums and outdoor sports areas, the maximum number of seats permitted on a row of seats shall be standardised according to the level of fire stability provided and the way in which users are evacuated in row, as set out in Table 130.

**(249)** In all categories of stadiums and arenas, special safety and comfort conditions are provided for disabled spectators. It is necessary to provide special spaces in the galleries so as to ensure that persons with disabilities have good visibility and convenient access (wheelchair ramps), as well as

*appropriate sanitary and care services designed for this category of spectator, in accordance with the specific rules in force.*

*(250) Disabled spectators, including those in wheelchairs, must be provided with access to the galleries (from the entrance to the stadium via the external closing gates) so as not to create difficulties for their use or to other spectators. Motor-disabled spectators shall not be located in any stadium area where their inability to move quickly would pose a risk to other spectators in the event of emergency evacuation.*

*(251) The aisles and spaces for circulation and rest are mostly on the large "distribution rings" behind the stands. Distribution and clearance circulations that constitute common escape routes behind the stands must have a width large enough to take over these functions. If these movements are covered, they will have a heel below the ceiling of at least **2.40 m** (under **2.40 m** no accident potential elements will be foreseen) and will be free of any obstacle. Particular attention will be paid to the strength of the materials used and of the current parapets or handrails (with a height of at least 1.20 m and equipped with bars to prevent climbing in the case of railings). The connection between access to the stadium and circulation behind the stands is made by wide stairs or ramps, necessarily with straight ramps, leading to a wide, free area, located between the stands and the outer enclosure. "Funnel" effects and sudden changes of direction will be avoided. The number of gates along these movements constituting common escape routes must be limited to the minimum.*

*(252) The evacuation gates in the outer enclosure (stadium outlet) shall be as large as possible. All gates shall open outwards (for evacuation purposes). It is not advisable to use sliding gates. Ideally, approximately half of the external closure can be opened when the public exits, being designed in such a way as not to encourage intrusions (minimum height of **2.50 m**, details that do not allow climbing, etc.).*

*(253) The public food facilities are usually located behind the stands, near the exits, but in such a way that they do not constitute an impediment to the evacuation flow. The furniture shall be located in such a way as to ensure access and circulation through passages with widths determined by calculation. When placing the furniture with seats at the tables, passages with standardized widths determined by calculation and through which the users can escape in case of fire must be ensured, they are placed according to the regulations in force taking into account the risk of conflict, aggressiveness and violence in sports, the factors and forms of manifestation of violence in sports as well as the methods of combating it.*

*(254) Areas intended for the medical service (to be taken into account depending on the capacity of the stadium or the arena, i.e. medical practice, refuge and/or first aid station) must ensure the safe and urgent evacuation of patients. In the case of a medical office or infirmary, there must be a separate route, properly sized for stretcher transport, which does not intersect with other traffic or cannot be obstructed by other traffic and has its own parking lot where an ambulance is stationed.*

*(255) The annexes with a role in the safety of the spectators (surveillance post, regrouping space for civilian security personnel, spaces for police forces with the possibility of viewing the entire surface of the stadium and spaces for firefighters) are located according to the regulations in force, taking into account the risk that it is constituted by the effect of panic on a large crowd of people.*

*(256) The surface intended for spectators, as well as the playing surface, including the access and exit/escape routes for players, must be supervised by various control and warning systems (the protection system adopted must be chosen in such a way that it does not pose a danger to the spectators and does not create panic during emergency evacuation).*

*(257) In case of the provision of barriers to direct traffic, they will be made and placed in such a way that they do not prevent the movement and safe evacuation of users in case of fire. The arrangement of barriers, stairs, passages and exits must be made in such a way as to ensure a fluid, quick and safe evacuation, aiming to avoid the funnel effect (access/exit paths that are too narrow).*

#### **ANNEX 7.4 - TALL, VERY TALL OR CIVIL BUILDINGS WITH crowded rooms**

##### **Tall and very tall buildings**

*(258) High-rise building - above-ground civil (public) building, where the upper level of the wear layer of the floor of the last level used by users is located at more than 28 m and less than 45 m from the level of the reference level ( $28\text{ m} < h < 45\text{m}$ ). Tall buildings must allow the access of special vehicles for emergency situations on at least two (2) adjacent sides and on at least 50% of the perimeter of the external walls when their shape is atypical.*

*(259) The following shall not be considered as high buildings:*

- buildings for production and/or storage;*
- multi-dwelling buildings with a maximum of 12 above-ground levels;*

*(260) Civil buildings (whatever their intended use) on which above the standard limit level there is a single built-up level occupying a maximum of 50% of the built-up area of the level below it and comprising only technical spaces associated with the building (lift rooms, heating and ventilation plants, etc.), functional circulation (corridors, hallways, buffer rooms, etc.) or ancillary spaces (laundry rooms, ironing rooms, drying rooms, etc.), without the permanent presence of persons.*

*(261) Underground levels shall not be taken into account when determining the high building type.*

*(262) Buildings located adjacent to the slope streets are not considered high when they have access to intervention on two sides in portions of the height (elevation) of the last floor usable below 28.00 m.*

*(263) In tall and/or very tall buildings, access and escape routes for fire-fighting vehicles must be provided on at least two (2) adjoining sides and at least 50% of the perimeter of the exterior walls.*

*(264) Civil (public) buildings in which above the limit level (28.00 m) there is a single storey occupying a maximum of 50% of the building's constructed area and comprising technical spaces are not considered tall buildings.*

*(265) Multi-family dwellings with a maximum of 12 storeys above ground level are not considered to be high-rise buildings, but one storey above ground level is allowed, occupying max. 50% of the floor area and intended EXCLUSIVELY for technical premises, laundry rooms, ironing rooms)*

*(266) In tall and very tall buildings it is mandatory to provide at least two separate and independent escape routes, so located as to ensure their judicious distribution and the possibility for persons to easily recognise the route to the outside.*

##### **Buildings with crowded rooms (escape lengths at crowded rooms)**

*(267) Crowded rooms shall have a minimum of two distinct and independent escape routes.*



*(268) Lengths of escape routes to crowded rooms shall comply with the standard conditions, depending on the category of the crowded room (S1, S2) and the level of fire stability of the construction*

## **ANNEX 7.5 - MIXED-FUNCTION CONSTRUCTIONS**

*(269) Mixed-function building - above-ground construction comprising different main civil-civil or civil-civilian functions of production and/or storage or production-storage.*

*(270) Distinct function (civil or production or storage) exceeding 50 % from the total developed area of the construction (Da), determines that the construction is classified as:*

- civilian mixed-function building, or*
- building with mixed functions predominant in production, or*
- building with mixed functions predominant in storage.*

*Note: When the building has several different civil purposes, namely production and/or storage, the function with the largest total area of construction (Ba) determines the civil function or the production or storage function of the building.*

*(271) If the civil building function is 50% of the developed area of the building (Da), it determines the classification of this building as a predominantly civil mixed function building.*

*(272) The fire risk per fire/construction compartment shall be considered the highest risk of rooms and areas:*

- whose **summed volumes** represent **more than 30 % of the construction volume** or the fire compartment, regardless of their destination, **whether areas are under construction** very high fire risk, **with volumetric explosion hazard**;*
- whose **summed areas** represent **more than 30 % of the deployed area** of the construction or fire compartment, regardless of their intended purpose.*

*(273) The determination of the **fire risk** of the civil (public) or production and/or storage building is done by taking the **arithmetic mean of the heat load in relation to the percentage occupied by the respective fire risk** per compartment/building (related to the area occupied by the respective risk).*

**Example:**

*If a building has .60% low risk, 20% medium risk and 20% high risk, the risk on the whole building is a **MEDIUM risk***

*(274) In a mixed-function building, the fire risk is determined as follows:*

- the most dangerous fire risk representing more than 30% in the developed area (Da) of a building portion (separated with fire resistant walls and floors), causes the fire risk for the entire portion; and*
- the most dangerous fire risk of a section of the construction, the area of which has been developed (Da) represents more than 30% in the developed area (Da) of that construction, determines the fire risk of the entire mixed-function construction.*

*Note: For existing buildings, the determination of whether a building is a mixed civil (public) or manufacturing and/or storage building may be analysed on a building portion-by-portion basis and then on an overall basis (taking into account the most restrictive value resulting) as follows:*

*(275) The fire risk irrespective of the distinct function (civil or production or storage which exceeds 50% of the building's developed area Da and which determines the classification of the building in question), shall be considered to be the greatest risk of rooms and areas whose combined areas represent more than 30% of the total developed area of the building or fire compartment, irrespective of their use. If there are areas of very high fire risk in the building with volumetric explosion hazard, the fire risk per fire compartment/building shall be considered to be the highest*

risk of rooms and areas whose combined volumes represent more than **30%** of the volume of the building or fire compartment.

*(276) Where the greatest risk of the aggregate areas of rooms and areas of the building, irrespective of the distinct function of the building, represents more than 30% of the total developed area of the building or fire compartment, this risk shall be considered relevant for the whole building.*

*(277) In buildings with mixed civil (public) functions, no spaces or rooms with an explosion hazard are allowed, except those explicitly permitted (heating plants, gas/medical fluid storage, etc.).*

## **ANNEX 7.6 – PRODUCTION AND/OR STORAGE CONSTRUCTIONS**

### **Location**

*(278) The standard conditions for limiting the possibilities for propagation of fires between buildings and fire compartments are mandatory and are achieved by placing them at the minimum safety distances set out in Table 4: Minimum safety clearances between above-ground buildings or fire compartments (civil, production and/or storage) or bounded by fire resisting fire compartment separating walls (fire walls) and, where appropriate, fire resisting fire compartment separating boards (fire boards), applying the provisions laid down in **Chapter II, Section III/ 2.3.** - ‘Fire propagation limitation’/2.3.2. - ‘Fire resistant elements for the separation of fire compartments and the protection of functional pass-through gaps’ and the indications in this annex.*

*(279) Production and/or storage constructions may be located at normal safety distances, or suitably sited in relation to neighbourhoods.*

### **Escape lengths at production and/or storage buildings**

*(280) In production and/or storage buildings, exhaust lengths shall comply with the standard values depending on the level of fire stability (see Table 114: Correlation conditions for built-up areas (Ba) and the number of levels of construction works and above-ground fire compartments of production and/or storage).*

*(281) Multi-storey construction with a minimum two-way discharge (as per Table 116: Escape lengths in production and/or storage constructions)*

*(282) In manufacturing and/or storage construction, users may also be considered as evacuation routes for users and those passing through:*

*a) rooms or spaces with low fire risks, if they serve to evacuate users of neighbouring production/storage facilities or their technical-social annexes, and in cases laid down in their specific technical rules;*

*b) rooms or spaces of medium fire risk, if they serve to evacuate users of adjoining spaces and do not constitute their only escape route, in which case the second escape route may also constitute a space of medium fire risk if the routes are distinct and separated from each other by fire resisting walls of at least **EI/REI 60** and the circulation gaps between them are protected by enclosures **EI<sub>2</sub>45-C5S<sub>200</sub>**;*

*c) rooms or spaces of high or very high fire risk if they serve to evacuate users of production or storage facilities with the same fire risk and do not constitute their only possibility of escape.*

*(283) In production and/or storage buildings, escape routes may also be considered as passageways passing through rooms or spaces having a fire risk less than or equal to that from which users are evacuated.*

#### **Enclosed escape stairways in production and/or storage buildings**

*(284) The evacuation stairs of users from above-ground production and/or storage buildings are separated from the rest of the building by a minimum of:*

- a) walls **EI/REI 180** reaction class to fire **A1** or **A2-s1d0**, floors **REI 90** reaction class to fire **A1** or **A2-s1d0** and doors compliant with **Article 6.1.5.6. paragraphs 1 and 2** in constructions with fire stability level **I**;*
- b) walls **EI/REI 120** reaction class to fire **A1** or **A2-s1d0**, floors **REI 60** reaction class to fire **A1** or **A2-s1d0** and doors compliant with **Article 6.1.5.6. (1) and (2)** in constructions with fire stability level **II**;*
- c) walls **EI/REI 90** reaction class to fire **A1** or **A2-s1d0**, floors **REI 45** reaction class to fire **A1** or **A2-s1d0** and doors compliant with **Article 6.1.5.6. (1) and (2)** in constructions with fire stability level **III**;*
- d) walls **EI/REI 45** reaction class to fire **A1, A2- s1d0** or **B-s1d0**, floors **REI 30** reaction class to fire **A1, A2- s1d0** or **B-s1d0** and doors compliant with **Article 6.1.5.6. (1) and (2)** in constructions with fire stability level **IV**;*
- e) walls **EI/REI 30** reaction class to fire **A1, A2-s1d0, B-s1d0** or **C-s1d0**, floors **REI 15** reaction class to fire **A1, A2-s1d0, B-s1d0** or **C-s1d0** and doors compliant doors with **Article 6.1.5.6. (1) and (2)** in constructions with fire stability level **V**;*

*(285) The landings, ramps and beams of the internal escape stairs will meet the fire behaviour conditions established in Art. 2.4.2.5. and Art. 2.4.2.6.*

#### **Access gaps to closed escape stairs from production and/or storage buildings**

*(286) The separation walls of stairway houses enclosures for the functional movement and evacuation of users from the rest of the construction shall also meet the conditions specific to those fire hazards and/or volumetric explosion in adjacent rooms.*

*(287) The hazard classes of the materials are also taken into account when determining their fire resistance.*

*(288) Gaps through which users of production and/or storage buildings have access to enclosed escape ladders shall be protected by:*

- a) fire-resistant doors **E 30-C5S<sub>200</sub>**, when they constitute an access way from rooms with a low fire risk;*
- b) fire-resistant doors **EI<sub>2</sub> 45-C5S<sub>200</sub>**, when they constitute an access way from rooms with medium fire risk;*
- c) fire-resistant doors **EI<sub>2</sub> 90-C5S<sub>200</sub>** or protected buffer rooms, ventilated under pressure (when they do not have windows directly to the outside), provided with fire-resistant doors **EI<sub>2</sub> 45-C5 S<sub>200</sub>** on the above-ground levels of the building and, respectively, with doors **EI<sub>2</sub> 90 -C5 S<sub>200</sub>** at underground levels, when it constitutes an access path from rooms with high fire risk;*
- d) protected buffer rooms, ventilated under overpressure and equipped with fire-resistant doors **EI<sub>2</sub> 90-C5S<sub>200</sub>**, when they constitute an access path from rooms with a very high risk of fire.*

#### **Horizontal common movement from production and/or storage construction**

*(289) The common horizontal functional circulations and evacuation of users from above-ground production and/or storage buildings are separated from the rest of the building by a minimum of:*

- a) **EI/REI 90** and reaction to fire class **A1** or **A2-s1d0** in constructions with fire stability level **I**;
- b) **EI/REI 60** and reaction to fire class **A1** or **A2-s1d0** in constructions with fire stability level **II**;
- c) **EI/REI 45** and reaction to fire class **A1** or **A2-s1d0** in constructions with fire stability level **III**;
- d) **EI/REI 30** and reaction to fire class **A1**, **A2-s1d0** or **B-s1d0** in constructions with fire stability level **IV**;
- e) **EI/REI 15** and reaction to fire class **A1**, **A2-s1d0**, **B-s1d0**, **B-s2d0**, **C-s1d0** or **C-s2d0** in constructions with fire stability level **V**.

**(290)** The walls separating the common horizontal functional circulations and evacuation from the rest of the construction, will also meet the specific conditions of the respective risks of fire and/or volumetric explosion in the adjacent rooms.

#### **Access openings to common horizontal circulation in production and/or storage buildings**

**(291)** Circulation gaps in walls separating common horizontal circulation in production and/or storage buildings shall be adequately protected against the specific fire hazards of adjacent rooms, i.e. with doors ensuring minimum:

- a) **E 15-C5S<sub>200</sub>** at low fire risk;
- b) **EI<sub>2</sub> 30-C5S<sub>200</sub>** at medium fire risk;
- c) **EI<sub>2</sub> 60-C5S<sub>200</sub>** at high fire risk;
- d) **EI<sub>2</sub> 90-C5S<sub>200</sub>** at very high fire risk, i.e. protected, overpressure-ventilated buffer rooms with fire doors **EI<sub>2</sub>90-C5 S<sub>200</sub>** at those which are also at volumetric explosion risk.

#### **Access openings to lifts for persons, goods or other mechanical means of vertical transport in production and/or storage buildings**

**(292)** The landing gaps through which users have access to passenger lifts, goods lifts or other mechanical means of vertical transport in production and/or storage buildings shall be protected with:

- a) **E 15** firetight doors where they constitute an access route from rooms of low fire risk;
- b) **EI 45** fire resistant doors, when they constitute access from rooms with a medium fire risk;
- c) **EI 90** fire resisting doors or protected, overpressure-ventilated buffer rooms (where there are no windows directly to the outside) fitted with **EI 45-C5S<sub>200</sub>** fire resisting doors on the upper levels of the building and protected, overpressure-ventilated buffer rooms fitted with **EI 90-C5S<sub>200</sub>** on the lower levels, respectively, where they constitute access routes from high fire risk rooms; protected, overpressure-ventilated buffer rooms with fire doors **EI 90-C5S<sub>200</sub>**, where they constitute access routes from rooms with a very high fire risk.

#### **Evacuation of smoke and hot gases from production and/or storage constructions**

**(293)** Air inlet and smoke exhaust devices by natural-organised draught ensure the exhaust of smoke over a maximum depth of **30 m** of the room from production and/or storage areas.

#### **Additional requirements for production and/or storage buildings**

**(294)** Buildings and storage rooms for lithium-ion batteries must be provided with minimum **REI180** walls, **EI<sub>2</sub>90-C5S<sub>200</sub>** doors (**EI<sub>2</sub>120-C5S<sub>200</sub>** doors for LiFePO<sub>4</sub> cell storage larger than 36 m<sup>2</sup> as well as for lithium nickel/manganese/cobalt cell storage regardless of area) and minimum

**REI120** floors. In all cases a minimum distance of **1.80 m** shall be provided from the accessible face of the battery rack to other stored non-combustible substances and materials as well as to building elements of reaction to fire class **A1** and to the accessible faces of adjacent battery racks. A minimum distance of **2.70 m** from the accessible faces of battery racks to other combustible substances and materials and to structural components other than those of reaction to fire class **A1** shall be provided. For multiple shelves installed in a single row or installed back-to-back, solid, gap-free, **A1** reaction-to-fire partitions must be provided between adjacent shelves. Non-combustible partitions or non-combustible partitions shall be provided from floor to floor (if any) or from floor to roof between adjacent shelves, perpendicular to accessible shelf openings, to prevent the spread of fire. In the conditions of storage halls, partitions shall be provided or fire class **A1** partitions shall be provided, which shall extend not more than **0,30 m** from the face of the storage rooms. The determination of the horizontal distance between partitions of reaction to fire class **A1** shall be based on the number of shelves and their associated area that can be protected by the automatic sprinkler system (depending on the triggering area of the automatic sprinkler system).

(295) Outdoor storage containers for lithium-ion batteries (equipped with controlled temperature maintenance systems) must be provided with minimum **REI60** walls and minimum **EI<sub>230</sub>-C5S<sub>200</sub>** doors (**EI<sub>260</sub>-C5S<sub>200</sub>** doors for those with an area greater than 36 m<sup>2</sup>) and must comply with the following criteria:

- be placed at a minimum distance of **10 m** when faced with adjacent constructions (excluding distances from other external lithium-ion battery storage containers),

- a minimum width of **1.50 m** shall be provided between containers towards the parts containing access doors or deflagration ports for containers with LiFePO<sub>4</sub> (lithium-iron-phosphate) cells,

- in the case of nickel/manganese/cobalt lithium cell containers a minimum width between containers of **4.00 m** shall be provided on the sides containing access doors or deflagration openings for containers fitted with **REI60** walls and **EI<sub>230</sub>-C5S<sub>200</sub>** doors and a minimum width between containers of **2,40 m** shall be provided on the sides containing access doors or deflagration openings for externally located containers fitted with minimum **REI120** walls and **EI<sub>260</sub>-C5S<sub>200</sub>** doors

## **ANNEX 7.7 – OPEN-SPACE TYPE PREMISES**

(296) Examples of open-spaces are shown in Figure 274.

## **ANNEX 8 - CHARACTERISTICS OF SUBSTANCES AND MATERIALS DETERMINING THE CLASSIFICATION OF SPACES, ROOMS, FIRE COMPARTMENTS AND PRODUCTION AND/OR STORAGE BUILDINGS AS FIRE HAZARDS**

### **ANNEX 8.1 - FIRE RISK CLASSIFICATION OF SPACES, ROOMS, FIRE COMPARTMENTS AND PRODUCTION AND/OR STORAGE BUILDINGS ACCORDING TO HEAT LOAD DENSITY**

(297) Heat load density values determining the fire risk classification of spaces, rooms, fire compartments and production and/or storage buildings are shown in Table 132.

**Additional classification of stored materials/products and substances by hazard class  
(recommendation)**

*(298) As a recommendation, stored materials/products and substances may also be classified according to their hazard according to the data in the technical/product data sheets and/or safety data sheets in accordance with the recommendations in Table 133 and Table 134. The responsibility for the adoption of measures regarding the storage of materials/products and substances with particularly high risk falls on the designer and the investor/beneficiary (regarding fire safety compliance measures regarding the appropriate way of storing substances or mixtures and the provisions regarding their dangerousness). The designer having regard to the design theme and the type, quantities and possible interaction of the stored materials/products and substances made available by the beneficiary according to the specific characteristics of the manufacturer, together with the technology, shall ensure compliance measures in relation to the stored products or mixtures and their hazardousness, for the adoption of protective and compliance measures on the fire safety line of the spaces concerned. In all cases the designers will also apply the methodology for categorisation of stored goods (as set out in SR EN 12845); and where water is not indicated as an extinguishing substance, automatic extinguishing systems with other substances referred to in the profile standard shall be provided.*

*(299) Classification of fire risks of spaces, rooms, fire compartments and production and/or storage buildings with stored materials/products and substances having the hazard class: no relevant hazard, low hazard, medium hazard as well as high hazard it is determined in accordance with the calculation of the thermal load density (according to Table 132) and measures are taken regarding fire limitation provided in the regulations.*

*(300) Characteristics, classification and packaging for stored materials/products and substances must comply with relevant European regulations.*

*(301) For the materials/products registered according to the provisions of the applicable European regulations, the specific fire fighting measures from the Safety Data Sheet, in accordance with the applicable European regulations, will be taken into account.*

**ANNEX 8.2 - CATEGORIES OF FLAMMABLE LIQUIDS - IN ACCORDANCE WITH  
REGULATION (EC) NO. 1272/2008 OF THE EUROPEAN PARLIAMENT AND OF  
THE COUNCIL ON 16 DECEMBER 2008**

**General provisions on the classification of flammable liquids**

*(302) The classification of flammable liquids shall be made into categories as set out in Table 135.*

*(303) Flammable liquid means a liquid having a flash point of not more than 60° C.*

**Additional considerations on the classification of flammable liquids**

*(304) For the classification of flammable liquids data on flash point and initial boiling point are needed. Data can be determined by testing, found in literature or calculated. If data are not available, the flash point and the initial boiling point shall be determined by testing. The closed vessel test method is used to determine the flash point.*

*(305) In the case of mixtures (1) containing known flammable liquids in defined concentrations, although they may contain non-volatile components such as polymers or additives, the flash point need not be determined experimentally if the calculated flash point of the mixture, using the method described in section 2.6.4.3 of Regulation (EC) No 1272/2008 of the European Parliament and of the Council of 16 December 2008, is at least 5 °C (2) higher than the corresponding classification criterion and provided that:*

- a) the composition of the mixture is known precisely (if the material has a composition that may vary within specified limits; the composition with the lowest calculated flash point must be selected for evaluation);
- b) the lower explosion limit of each component is known (an appropriate correlation must be applied when these data are extrapolated to temperatures other than the test conditions) and a method for calculating the lower explosion limit;
- c) the temperature dependence of the saturated vapour pressure and the activity coefficient for each component in the form in which it is present in the mixture is known;
- (d) the liquid state is homogeneous.

**(306)** For a mixture containing non-volatile components the flash point is calculated from the volatile components. It is considered that a non-volatile component only slightly decreases the partial pressure of the solvents and the calculated flash point is only slightly below the measured value.

#### **Categories of flammable liquid deposits**

**(307)** Depending on the flammability of liquids and the capacity stored, the categories of combustible liquid deposits are specified in Table 136.

## **ANNEX 9 – CALORIFIC VALUES**

**(308)** The calculation of the heat load determining the fire risk classification of spaces, rooms, fire compartments and production and/or storage buildings shall be made using the values of calorific values for usual materials as set out in Table 137.

### **ANNEX 9.1 - CALORIFIC VALUES FOR USUAL MATERIALS**

### **ANNEX 9.2 - CALORIFIC VALUES FOR CABLES**

**(309)** The calculation of the heat load for cables shall be carried out using the calorific values for the cables in accordance with Table 138.

**(310)** The calculation of the heat load shall be carried out as follows: from the value of the weight of one km of cable, subtracts the weight of copper and then divided by 1,000 to give the specific weight in kg/m and multiply the value obtained by the calorific value corresponding to the material.

## **ANNEX 10 - EXISTING BUILDINGS**

**(311)** The provisions of this Annex shall be compulsory for works carried out on existing buildings which do not extend, irrespective of the form of ownership, category and class of importance or source of financing, in order to protect the life of people, their property, society and the environment. Applies to alterations to existing buildings that are established as built heritage prior to the effective date of the regulation that are not being extended and that hold or do not hold all documents relating to the design, execution, reception, operation, maintenance, repair and tracking of the construction over time. In the case of interventions carried out on existing buildings constructed on the basis of this Annex (of existing buildings which were built prior to the date of entry into force of the regulations), where it is technically justifiable that some of the standard fire safety requirements cannot be met, alternative protective measures (passive, active or combinations thereof) shall be provided to meet the requirements which cannot be met.

**(312)** Modifications to existing constructions constituting a building stock prior to the date of entry into force of the legislation shall comply with the following:

a) Interventions to existing constructions which are not extended shall be carried out preserving the fire performance of the construction elements to be replaced in accordance with the regulations applicable at the time of their realisation (in accordance with Annex 10), and the equipping with fire safety installations shall be carried out in accordance with the technical regulations in force.

Note letter a): Intervention works carried out on existing constructions (in accordance with improving fire safety requirements, or **letter a)**), where it is technically justified that some of the fire safety requirements are not met by means of **Annex 10**, ensure measures protective alternatives (liabilities, assets or combinations thereof) established in accordance with **Article 12** of the Rules of Procedure for the verification and technical inspection of projects, the technical inspection of the execution of works and constructions, and the verification of the quality of the works carried out, approved by **Government Decision No 925/1995**, as amended. Measures to improve fire safety requirements or alternative protective measures (passive, active or combinations thereof which are mandatory to cover requirements that cannot be complied with), are carried out on the basis of technical expertise (s) for the fundamental requirement of fire safety (buildings and/or installations), drawn up on the basis of **Article 9** and **Article 12** of the Regulation on the technical verification and inspection of projects, the technical inspection of the execution of works and constructions, and the verification of the quality of the works carried out, approved by **Government Decision No 925/1995**, as amended. The measures proposed by the technical expert (s) to improve the fire safety requirement must be aimed at satisfying the requirements that cannot be complied with, where it is justifiably technically impossible to meet some standardised fire safety provisions.

b) Extension works to existing buildings shall be carried out preserving the fire performance of the construction elements of the existing building volume (which shall be replaced in accordance with the regulations applicable at the time of their realisation, in accordance with Annex 10 of the regulations), and extension works outside the existing building volume shall be carried out in accordance with the technical regulations in force as follows:

- i. If the **extension** works to existing buildings are also separate fire compartment(s) (minimum one), a fire wall shall be provided between the existing building and the extension. Fire walls between existing buildings which are extended by other new fire compartments (minimum one) shall be constructed in accordance with the provisions of the Rules (Chapter 2.3.2.1. **Fire resistant walls for the separation of fire compartments**), but at least 3 hours (**EI-M180/REI180**). Fire walls in extensions to existing buildings (with the exception of those previously provided for between the existing building and the extension(s)) shall be constructed in accordance with the provisions of the Rules (Chapter 2.3.2.1. **Fire resistant walls for the separation of fire compartments**). The works of interventions to existing constructions that keep their destination shall be carried out preserving the fire performance of the construction elements of the existing building volume (which shall be replaced in accordance with the regulations applicable at the time of their realization, in accordance with **Annex 10**), and the extension works from the outside of the existing building volume shall be carried out in accordance with the technical regulations in force for new constructions.
- ii. Where **extension** works to existing buildings **do not constitute** as separate fire compartment(s) (minimum one), fire resisting walls with the following performance levels shall be provided between the existing building and the extension:
  - REI 180/EI-M 180 (reaction to fire class A1 or A2-s1,d0) fitted with EI<sub>1</sub> 90-C5S<sub>200</sub> doors with Level I fire stability/fire resistance class I
  - Level II - REI 120/EI 120 (reaction to fire class A1 or A2-s1,d0) fitted with EI<sub>2</sub> 60-C5S<sub>200</sub> doors with Level II fire stability/fire resistance class II
  - REI 90/EI 90 (reaction to fire class A1 or A2-s1,d0) fitted with EI<sub>2</sub> 45-C5S<sub>200</sub> doors with Level III fire stability/fire resistance class III
  - REI 60/EI 60 (reaction to fire class min B-s1,d0) fitted with EI<sub>2</sub> 30-C5S<sub>a</sub> doors with Level IV fire stability/fire resistance class IV



- REI 30/EI 30 (reaction to fire class min C-s1,d0) fitted with EI<sub>2</sub> 15-C5S<sub>a</sub> doors with Level V fire stability/ fire resistance class V

Extension works to existing buildings which do not constitute separate fire compartment(s) (minimum one) shall comply with the following conditions:

- the entire resulting fire compartment shall comply with the minimum requirements to be met by the main elements of the existing construction (existing fire compartment) in such a way that the entire existing construction or existing compartment can be classified within a certain level of fire stability (previously referred to as 'fire resistance rating') according to **Table 144 of Annex 10**;

- the built-up areas of the resultant permitted fire compartments for existing above-ground resultant civil (public) buildings shall comply with the correlation conditions laid down in **Table 147 of Annex 10** and between the number of storeys of the resultant existing above-ground resultant buildings, their intended use, their fire stability level and their capacity (number of persons), the correlations laid down in **Art. A.10. 3.2.5. of Annex 10**.

Note letter b): Work on existing buildings (from the volume of existing construction, excluding extensions), where it is technically justifiable that some of the fire safety requirements are not met by improving fire safety requirements, or **Annex 10**, ensure measures protection alternatives (liabilities, assets or combinations thereof), established based on **Article 9** and **Article 12** of the Regulation for the verification and technical inspection of projects, the technical inspection of the execution of works and construction works, and the verification of the quality of the works carried out, approved by Government Decision No 925/1995, as amended. Measures to improve fire safety requirements or alternative protective measures (passive, active or combinations thereof which are mandatory to cover requirements that cannot be complied with), are carried out on the basis of technical expertise (s) for the fundamental requirement of fire safety (buildings and/or installations), drawn up on the basis of **Article 9** of the Regulation on the technical verification and inspection of projects, the technical inspection of the execution of works and constructions, and the verification of the quality of the works carried out, approved by **Government Decision No 925/1995**, as amended. The measures proposed by the technical expert (s) to improve the fire safety requirement must be aimed at satisfying the requirements that cannot be complied with, where it is justifiably technically impossible to meet some standardised fire safety provisions.

## **SECTION I**

### **PROVISIONS COMMON TO ALL EXISTING CONSTRUCTIONS**

#### **CHAPTER 1**

#### **GENERAL INFORMATION**

##### **A.10. 1.1. PURPOSE - SCOPE**

**A.10. 1.1.1.** Interventions on existing buildings which hold all documents relating to the design, execution, reception, operation, maintenance, repair and follow-up of the construction and which do not hold all documents relating to the design, execution, reception, operation, maintenance, repair and follow-up of the construction shall be carried out in accordance with this Annex. The Annex sets out the main conditions, performance and performance levels for existing buildings built before the adoption of these Rules and is intended to ensure a minimum degree of fire and life safety for people using existing buildings. The measures set out in the Annex shall be minimal and non-limitative. In the case of works carried out on existing buildings which retain their intended use, where it is technically justifiable that certain fire safety requirements laid down in this Annex cannot be met, alternative protective measures (passive, active or combinations thereof) shall be provided to improve the requirements which cannot be met.

**A.10. 1.1.2.** The provisions of this Annex are mandatory for existing construction works (buildings) of any kind - hereinafter referred to under this Annex as “Constructions” - regardless of the form of ownership or destination.

**A.10. 1.1.3.** This Annex does not cover technological production installations and equipment (systems, machines, aggregates, devices, etc.) including their assembly projects and constructions intended for the manufacture, handling and storage of explosives, open-air technological installations, nuclear constructions, underground hydroelectric and underground railway constructions, etc. and those specific to site organisation.

**A.10. 1.1.4.** For existing historic or architectural monuments, the provisions of this Annex shall be of a recommended nature and only measures to improve safety to fire possible to be carried out shall be taken on a case-by-case basis, without affecting the character of the monument.

**A.10. 1.1.5.** For existing constructions and objectives of national defence, public order and national security structures nominated by order of the managers of those structures, the provisions of this Annex are not mandatory. They shall ensure the fire safety measures established by their own specialist bodies approved by the managers of the structures concerned.

**A.10. 1.1.6.** The conditions laid down in ‘**SECTION I - 1.1. Subject matter, scope of CHAPTER 1-1. GENERAL PROVISIONS**’ of the Rules, relating to:

- general provisions, common performance and specific provisions that are binding on all actors assigned according to **Article 1.1.2.** paragraphs 1 and 2 of the Rules;
- the measures taken with regard to the fire behaviour and fire safety measures of the main building materials, products and components and installations used in the design and construction of buildings shall be as laid down in **Article 1.1.10.** paragraph 1 of the Rules;
- the assessment of the reaction-to-fire performance of building elements will comply with **Article 1.1.8.** paragraph 1 of the Rules.

## **A.10. 1.2. TERMINOLOGY, CLASSIFICATIONS**

**A.10. 1.2.1.** Applicable in accordance with ‘**SECTION II/1.2. Terminology, classifications**’ of the current Rules.

**A.10. 1.2.2.** For the purposes of this Annex, the terminology and classifications used have the meanings specified in ‘**SECTION II 1.2. Terminology, classifications**’ of the Rules, as well as the following meanings specific to this Annex:

**a) Combustion class** - a characteristic of a material or element, expressed by the level of specific parameters determined by standardised tests.

**b) Combustibility of building materials and elements** - their ability to ignite and burn further, contributing to the increased amount of heat developed by the fire. Materials and substances to be stored, classified as hazard classes, symbolised **P1** to **P5**.

Depending on the reaction to fire, building materials and elements may be:

- non-combustible (**A1, A2s1d0** in compliance with Table 139

- combustible in compliance with Table 140

**c) Fire compartment** - a freestanding construction (installation), as well as a grouped or combined construction located at the prescribed distances from neighbours or a built volume partitioned by fire walls from adjacent constructions (installations). In existing tall and very tall buildings the fire compartment may be an enclosed volume, consisting of one to three successive storeys, bounded by

fire resisting elements according to this Annex and with a total developed area according to the permitted fire compartment for civil (public) buildings of fire stability level I.

**d) Existing constructions (buildings)** - existing above ground (with or without basements or crawl spaces) or underground built objects with the following uses and functions:

- civil (public) - for housing, administration, trade, health, culture, education, sport, tourism, etc.;
- production and/or storage - for specific basic or ancillary activities, (halls, workshops, warehouses, etc.);
- mixed - for various civil (public), production and/or storage activities, or civil (public) and production and/or storage activities, embedded in the same constructed volume.

**Note:**

Existing agro-industrial and agro-zootechnical buildings shall be treated, where appropriate, by assimilation with existing civil or production or storage buildings, depending on their purpose.

**e) Existing armoured construction (building)** - an above-ground enclosed construction in which the activity is carried out under artificial light only, having a roof and full perimeter enclosure walls, in which only psychological gaps and access doors are provided. Armoured spaces with a built-up area (Ba) greater than 1,000 m<sup>2</sup> are considered to be armoured constructions.

**f) Existing monobloc construction (building)** - an enclosed construction with a built-up area (Ba) of at least 20,000 m<sup>2</sup> and a width of more than 72 m.

**g) Block** - built-up area bounded by adjacent intersecting streets.

**h) Degree of resistance to fire** - overall capability of the construction or fire compartment to respond to the action of a standard fire, regardless of its intended purpose or function. It is equivalent to the term specified at **SECTION II 1.2. / Terminology, classifications/No. 53 Level of fire stability** of the Rules.

**i) Existing cladding panels** - existing self-supporting elements mounted on the roof frames of existing buildings, acting as water and heat insulation.

**j) Existing fire wall or floor** - a vertical or horizontal building element made of materials of reaction to fire class **A1, A2s1d0**, having a fire resistance at least equal to the level determined by reference to the highest thermal load density of the existing fire compartments which it separates, conforming to and constructed in accordance with the provisions of this Annex.

**k) Fire risk** - the likelihood of fires breaking out in rooms, buildings or fire compartments or installations; in those with existing civil (public) functions is expressed by fire hazards, and in those for existing production and storage activities is expressed by 'fire hazard categories'.

## **CHAPTER 2**

### **GENERAL PERFORMANCE CONDITIONS OF EXISTING BUILDINGS**

#### **A.10. 2.1. FIRE RISK AND FIRE STABILITY LEVEL**

##### **Risk of fire**

**A.10. 2.1.1.** In existing civil (public) buildings the fire risk is mainly determined by the calculated heat load density ( $q$ ) and the intended use according to Art. 2.1.2.1. and Art. 2.1.2.2.

**A.10. 2.1.2.** Depending on the heat load density, the fire risk in existing civil (public) buildings can be:

- high:  $Q_i = \text{above } 840 \text{ MJ/m}^2$
- medium:  $Q_i = 420 \text{ MJ/m}^2 \div 840 \text{ W/m}^2$
- small:  $Q_i = \text{below } 420 \text{ MJ/m}^2$

**A.10. 2.1.3.** Depending on their purpose (function), some spaces and rooms in existing civil (public) buildings fall into the following fire risks:

- high: where combustible materials or substances are used or stored (archives, libraries, multiplication, car parks, etc.)
- medium: where open fires are used (kitchens, central heating plants, hot food preparation offices, etc.);
- small: other rooms and spaces.

In rooms and premises equipped with automatic fire extinguishing systems, high fire risks can be considered medium and medium risks can be considered low. For the entire fire compartment or existing building, the fire risk considered shall be the highest fire risk representing at least 30% of their volume.

**A.10. 2.1.4.** In existing production and/or storage buildings, the fire risk takes into account the nature of the activities carried out, the combustion characteristics of the materials and substances used, processed, handled or stored, and the heat load density, the provisions of Table 143 shall be taken into account. In these, fire risk is defined by the previous fire hazard categories, which express:

- categories **A** (BE3a) and **B** (BE3b): possibilities for fire and volumetric explosion (very high fire risk);
- category **C** (BE2): fire/burning possibilities (high fire risk);
- category **D** (BE1a): the existence of open fire in any form in the absence of combustible substances (medium fire risk);
- category **E** (BE1b): existence of non-combustible materials or substances in a cold state or of combustible substances with a high moisture state, above 80 % (low fire risk).

**A.10. 2.1.5.** The areas in the existing production and/or storage rooms, rooms, compartments and constructions will have the fire risk defined (each separately) by one of the five fire hazard categories, according to the provisions of Table 143, depending on the fire hazard determined by the physical-chemical properties of the materials and substances used, processed, handled or stored - including machinery, shelves, pallets, packaging, etc. For existing constructions and fire compartments, the equivalence of the former fire hazard categories will be considered, according to the provisions of Table 143 (depending on the fire hazard determined by the physico-chemical properties of the materials and substances used, processed, handled or stored - including machines, shelves, pallets, packaging, etc.) with the characteristics of substances and materials that determine the classification of spaces, rooms, fire compartments and production and/or storage buildings as fire risks.

**A.10. 2.1.6.** Fire risks (former categories of fire danger) are established by zones and rooms as well as independently for each existing fire compartment and existing construction, and must be mentioned in the technical-economic documentation. The most dangerous risk (the most dangerous hazard category) of non-compartmentalized fire existing in a room (space), fire compartment or existing construction, as a rule, determines their risk (hazard category), with the following exceptions:

- categories **A** and **B** fire hazard the associated volume of which is less than 5% of the volume of the room or compartment concerned;
- categories **C** and **D** of fire hazard with an associated volume of less than 10% of the volume of the room or compartment in question, not exceeding an area of 400 m<sup>2</sup>.

In the exempted cases, measures shall be taken to reduce the possibilities for local concentration with an explosion hazard and the spread of fire to neighbouring areas within the room or compartment concerned. In the case of more than one non-partitioned fire hazard category situated at distinct points of the existing room or compartment, the sum of the corresponding volumes and the actual areas of each hazard category shall be taken into account. For categories **C** and **D** (BE2

and BE1a) of fire hazard summation only applies if the distance between those spaces is less than 40 m (measured horizontally). For existing fire compartments or structures, the most dangerous fire hazard category shall extend to their entire volume when it accounts for more than 30 % of the built volume of the compartment or construction.

**A.10. 2.1.7.** In determining the concentration of the explosion mixture in existing buildings, account shall be taken of escapes and releases of gases, vapours or dust, both during normal operation and in accidental cases of design damage to the associated utility installations.

**A.10. 2.1.8. (1)** It is recommended that when estimating fire risk, i.e. the likelihood of a fire starting and its consequences occurring, the following elements should usually be taken into account:

- a) the fire hazards identified;
- b) the levels of the performance criteria for construction works relating to the fundamental requirement 'fire safety';
- c) the level of equipment and equipment with systems, installations, equipment and appliances for the supply of water, combustible gases, electricity and heat, ventilation and air-conditioning, their operational status and performance;
- d) the human factor, determined by the number of persons, their age and physical condition, their educational attainment;
- e) other elements which may influence the production, development and/or spread of a fire.

**(2)** For the estimation of fire risk, it is recommended that the following factors be taken into account:

- a) the likelihood of starting a fire (possible sources of ignition depending on the nature of the activities carried out as well as circumstances that may favour ignition);
- b) the use of the building and the development, severity and propagation possibilities of the fire, determined according to the density of the heat load (q) and/or the rate of heat release due to the types and quantities of products used and housed materials;
- c) the categories of users of the building;
- d) the level of ensuring the protection of goods in some cases, construction products, the environment and business continuity.

### **Fire stability level**

**A.10. 2.1.8.** The minimum requirements to be met by the main elements of the existing construction (existing fire compartment) so that the whole existing structure or compartment can be classified within a certain level of fire stability (previously referred to as the 'degree of fire resistance') are given in Table 144.

**A.10. 2.1.9.** All the main elements of the existing construction, depending on their role, must meet the minimum reaction and resistance to fire conditions prescribed for classification with that level of fire stability. In order for an existing building element to meet a certain level of fire stability, it must meet both the minimum requirements (both fire performance and fire resistance) specified in Table 144.

**A.10. 2.1.10.** The fire resistance rating (fire stability level) of the existing building or of an existing fire compartment is determined by its most unfavourable rating element and shall be specified in the technical-economic documentation. The provisions specified in Art. 2.1.3.3. of the Rules shall also be taken into account.

**A.10. 2.1.11.** In determining the fire stability level of the existing building or existing fire compartment, the following shall not be taken into account:

**a)** the roof and roof support of buildings of fire stability class **II** or **III** with attic, if the floor to the attic is not suspended from the roof rafters and the roof gaps are protected by fire-resisting closures for at least **30** minutes. In existing tall and very tall buildings the roofs with attics will be made entirely of materials of reaction to fire class **A1, A2s1d0**. The roof and roof support of loft buildings must comply with the following:

- for fire stability level **II**, if the floor to attic has fire resistance **REI 30 (A1, A2s1d0)** and is not suspended from the roof ridge and the gaps in the floor to attic are protected with fire resisting closure elements of minimum **EI 30**, normally closed;

- for fire stability level **III**, if the floor to attic has fire resistance **REI 30 (min A2s1÷s3, d0÷d1, B s1÷s3, d0÷d1)** and is not suspended from the roof rafter and the gaps in the floor to attic are protected with fire resisting closure elements minimum **EI 30**, normally closed;

**b)** roof coverings of all kinds, with the exception of roofing panels specified according to **Table 144, point 8 letter b)**, and non-combustible thermal insulation and waterproofing installed over a continuous **A1, A2s1d0** fire-resistant substrate according to **Table 144**;

**c)** rooflights whose aggregate area (in horizontal projection) is less than 25% of the area of the space in which they are installed, but not more than 25 m<sup>2</sup>, irrespective of their reaction to fire class;

**d)** atrium skylights (regardless of their area) or rooflights with an area greater than 25% of the area of the space in which they are located, when made of profiled structures of reaction to fire class **A1 or A2-s1d0**, with the exception of non-substantial components, insulators and gaskets, and infill panels made of glazing elements (glass), plain or insulating, or products of reaction to fire class **A1 or A2-s1d0**.

**e)** floors and joinery (doors, windows, shutters), including fixed strips for natural lighting made of materials not exceeding **D s1÷s3, d0÷d1**, in an area not exceeding **10%** of the external wall area and so arranged and interrupted as not to encourage the spread of fire from one level to another and throughout the existing building (except in those cases where explicitly stated in the Annex).

**f)** structural bracing, platforms and metal elements that are functionally or technologically necessary and are not taken into account in the strength and stability of the construction in the event of fire;

**g)** the constructive elements located on the ground floor of the awnings, windfronts, verandas, porches, gazebos, open terraces and greenhouses;

**h)** functional internal partitions of reaction to fire class **A1 or A2-s1d0** in open-plan spaces with a maximum standard surface area and other categories of combustible partitions whose use is permitted under the Rules (**Art. 2.1.3.4. letters h), i) and j)**).

**i)** non-substantial components, trims, insulators, simple or insulating (glass) glazing elements of exterior doors and windows, including those inserted in curtain walls.

**j)** metal platforms and metal elements which are not part of the structure of the building.

**A.10. 2.1.12.** In existing constructions where the heat load density does not exceed 420MJ/m<sup>2</sup> and the combustible materials are so distributed that they do not endanger the stability of the construction by local heating of building elements during fire, the use of unprotected or partially protected metal structures and an appropriate reduction of the fire resistance of columns, walls and floors up to a minimum of 15 minutes is allowed, the existing structure being deemed to meet the requirements for fire stability level II. Under the same conditions the fire resistance of columns, walls and floors made of other materials may also be reduced. Existing high, very high and crowded buildings and buildings for people who cannot evacuate themselves (existing buildings for pre-school children / existing buildings for pre-school education (0 - 3 years) (nurseries and children's homes), existing buildings with a hospital function or with a hospital character

(hospitals, maternity wards, polyclinics, medical stations, dispensaries, multi-purpose medical and health centres, clinics and outpatient medical units similar to polyclinics, medical centres for diagnosis and treatment, nursing homes or homes for the elderly and disabled, hospices for the mentally ill, sanatoriums, etc.)] as well as in production and/or storage facilities shall also comply with their specific provisions.

**A.10. 2.1.13.** *Unprotected or partially protected metal structures may be used for intervention work carried out on existing buildings located within the same fire compartment under the conditions generally laid down in the Annex to:*

- *compartments and spaces equipped with automatic water extinguishing systems that provide cooling of elements during the normal time,*
- *above-ground constructions with a maximum of 15.00 m height.*
- *the construction works referred to in the preceding paragraph, with the exceptions provided for.*

**A.10. 2.1.14. (1)** *When using unprotected or partially protected metal structures, account shall be taken of the role of the element in ensuring the stability of the existing construction, the category of importance of the construction, the number of persons and their capacity for self-evacuation, the value of the goods housed and the possible consequences of the construction collapse due to the action of fire.*

**(2)** *For the extension of existing buildings with other fire compartments (minimum one) or for changing the use of existing ones, the provisions of **Article 2.1.3.3. ÷ Article 2.1.3.5.** of the Rules.*

## **A.10. 2.2. LOCATION OF BUILDINGS AND THEIR FIRE COMPLIANCE**

### **Location**

**A.10. 2.2.1. (1)** *The existing above-ground civil, production and/or storage constructions can be located at the standard distances from the neighbours (Figure 28 - Independent location of the constructions (at standard distances) respecting the distances provided in Table 145, delimited with fire-resistant walls of separation of fire compartments (fire walls) and, as appropriate, fire-resistant floors separating fire compartments (fire floors) (Figure 29 - Compartmentalized location) according to the conditions provided in the annex or can be placed together (Figure 30 - Location combined constructions within the limits of the areas of the standard fire compartments (fire compartment Ba = sum of Ba of combined constructions).*

**(2)** *Existing above-ground civil (public) production and/or storage constructions are usually placed together or grouped at unusually separated distances within specific fire compartments, with maximum permitted areas depending on the destination, the least favourable fire stability level, the fire risk and the number of standard levels (taking into account the sum of the actual built-up areas).*

**(3)** *Existing residential buildings of normal height, without crowded rooms and with low fire risk may be allowed without standardisation of distances between them within existing buildings for which there are external hydrant networks sized for the worst case situation, compensatory measures aimed at limiting the spread of fire from one building to another, depending on the worst-case stability level of the existing buildings, the maximum number of storeys permitted, taking into account the effective sum of the built-up areas of the existing buildings, within the maximum permissible limit for a fire compartment according to Figure 274. The fire stability level of the existing construction shall be determined by its most unfavourable element within the standard values and the level of fire stability resulting from the merger of existing buildings of the fire compartment is determined by the fire stability level of the most unfavourable pooled construction relative to the classification in the standard values in the Annex. The maximum permitted areas of a fire compartment may not be marked on their own.*

**A.10. 2.2.2.** Existing detached buildings and existing groupings or combinations of buildings formed in accordance with Art. A.10.2.2.1., shall be located so as not to permit the spread of fire for a prescribed period of time or, in the event of collapse, not to affect neighbouring objects, observing the minimum safety distances in Table 145 or compartmentalised by fire resisting walls constructed to the highest thermal load density according to the regulations and this Annex.

**A.10. 2.2.3.** Existing buildings with different uses or functions, grouped or merged within a fire compartment, shall be separated from each other by walls and floors appropriate to the uses, risks and fire categories, and the heat load density, as specified in the Rules and this Annex, and between fire compartments, if safety clearances are not provided, vertical fire separators or fire resisting partitions (walls) of materials of reaction to fire class A1, A2s1d0, fire resisting to the heat load density but not less than 3 hours (REI180) and, where applicable, explosion proof shall be provided. In existing tall and very tall buildings, fire compartments may be constructed according to their specific provisions.

### **Fire compliance**

**A.10. 2.2.4.** The existing buildings as a whole and their building elements must be so constructed and brought into conformity as not to favour the spread of fire and smoke.

**A.10. 2.2.5.** As far as possible, high fire risk activities shall be carried out in separate areas of the existing construction and those with explosion hazard at the last level. When this arrangement is not technically or functionally feasible, the necessary protective and partitioning measures shall be taken, in accordance with the provisions of the Regulation and this Annex.

**A.10. 2.2.6.** By arranging the functions in the existing construction and ensuring appropriate protective measures, the aim shall be to eliminate the possibilities for the easy spread of smoke and fire outside the compartments in which the fire occurred and to protect them from the action of a fire in their vicinity.

**A.10. 2.2.7.** The different functions in an existing construction typically separate with vertical and horizontal building elements resistant to fire in such a way that they do not endanger the life of users for a specified time.

**A.10. 2.2.8.** Existing buildings with mixed functions (civil, production and/or storage) shall have dangerous functions arranged in separate areas and shall be provided with separation elements appropriate to the hazards and fire categories and the density of their thermal load, through fire resistant walls and floors, the required functional gaps of which shall be protected in accordance with the provisions of the legislation and of this Annex.

**A.10. 2.2.9.** In order to limit the spread of smoke and fire in existing constructions, fire compartments shall be carried out, and within these compartments it is recommended to provide fire resistant separation elements.

**A.10. 2.2.10.** The permissible built-up areas for fire compartments of existing civil (public), production and/or storage buildings are differentiated in this Annex according to the level of fire stability and the intended use of the building concerned as specified in Table 145.

## **A.10. 2.3. LIMITING THE SPREAD OF FIRES**

### **General provisions**

**A.10. 2.3.1.** The building elements, walls and floors used to limit the spread of fires and their effects and explosions are of the type:

- fireproof (REI or EI-M);
- fire-resistant (REI or EI);
- explosion resistant (REI);



- fire tight (E)

The protection of functional gaps in these building elements shall be carried out, where appropriate, with doors, shutters, curtains, buffer rooms or open drums, constructed and sized in accordance with the regulatory provisions.

**A.10. 2.3.2.** Depending on the highest density of the heat load in the spaces they separate, the walls in existing constructions typically need to withstand fire according to Table 146, if the provisions of the Annex do not lay down any other conditions.

### **Fire resistant elements for the separation of existing fire compartments and the protection of functional passage gaps**

#### **Fire walls**

**A.10. 2.3.3.** Fire walls in existing buildings shall be made of **A1, A2s1d0** materials, so placed, constructed and dimensioned as to resist the effects of fires in the fire compartments which they separate.

**A.10. 2.3.4. (1)** Fire walls in existing buildings shall perform the function of partition in case of fire, maintaining their stability, mechanical strengths and thermal insulation capacity during the normed time, depending on the thermal load density according to Table 146, but at least 3 hours (REI180).

**(2)** Fire walls between existing buildings which are extended by other new fire compartments (minimum one) shall be constructed in accordance with the provisions of the Rules (Chapter 2.3.2.1. Fire resistant walls to separate fire compartments), but at least 3 hours (REI180).

**(3)** Fire walls within extensions to existing buildings (except those referred to in A.10. 2.3.4 paragraph 2 between the existing building and the extension/extensions) is carried out according to the provisions of the Rules (Chapter 2.3.2.1. **Fire resistant walls for the separation of fire compartments**).

**A.10. 2.3.5.** In existing ground floor buildings and in the cases specified in this Annex, fire partition may be achieved by fire partition walls of reaction to fire class **A1, A2s1d0** which provide only the fire resistance specified in Art. A.10. 2.3.2. and in Table 146.

**A.10. 2.3.6.** In existing constructions with reinforced concrete or metallic structures, the fire walls may be incorporated directly into such structures, which shall be so constructed or protected as to have fire resistance at least equal to that required for those fire walls.

**A.10. 2.3.7.** Existing construction fire walls which separate, in certain portions of them, explosion hazard spaces must meet the conditions laid down for explosion-resistant walls in these portions.

**A.10. 2.3.8.** The embedding in fire walls of floor slabs or structural elements with a fire resistance of less than 2 hours (REI 120 for floor slabs and R 120 for beams, trusses, etc.) is not allowed, only their reservation (free or hinged) is permitted. The deflection of metal beams on fire walls shall be carried out in such a way that the dilated beam does not give lateral pushing into the fire wall.

**A.10. 2.3.9.** Joints between existing fire walls and floor slabs, columns, roofs and exterior walls of existing construction shall be sealed with materials providing a fire resistance of at least 1 hour and 30 minutes (EI90).

**A.10. 2.3.10.** Fire walls in existing buildings must exceed the external plane of roofs, rooflights, walls of reaction to fire class **Ds1÷s3,d0÷d1** or reaction to fire class **A2s1÷s3,d2; Bs1÷s3,d2; Cs1÷s3,d2; Ds1÷s3,d2; ED2**it intersects (Figure 36 – Separate fire compartments of equal heights by passing the roof by a minimum of 60 cm (fire wall) and Figure 37 – Overcoming the external planes of roofs and combustible walls and according to Figure 275), as follows:

- **60 cm** (measured vertically) from any such combustible roof and rooflight elements within **4.00 m** of the fire wall of existing buildings, including sheet metal backed roofs with non-combustible thermal and/or water insulation.

- **30 cm** (measured horizontally) from external walls and overhangs of reaction to fire class **Ds1÷s3,d0÷d1** or reaction to fire class **A2s1÷s3,d2; Bs1÷s3,d2; Cs1÷s3,d2; Ds1÷s3,d2; Ed2**.

**A.10. 2.3.11.** The overriding by fire walls in existing buildings of the plane of roofs with cladding and thermal insulation made of combustible materials mounted on reinforced concrete slabs and roofs made entirely of materials of reaction to fire class **A1, A2s1d0** is not mandatory.

**A.10. 2.3.12.** Fire resistant walls of existing fire walls referred to in Article. **A.10. 2.3.5.** must extend beyond the outer plane of the combustible roofs, rooflights, walls, etc. they intersect, as specified for fire walls.

**A.10. 2.3.13.** On roofs, at least reaction class to fire **4.00 m** on either side of the fire or fire resistant wall in existing constructions, the luminaires shall be of materials **A1, A2s1d0**, fixed and reinforced glazing (no moving meshes).

**A.10. 2.3.14.** Exceeding the plane of combustible roofs, niches or walls, reaction to fire class **Ds1÷s3,d0÷d1** or reaction to fire class **A2s1÷s3,d2; Bs1÷s3,d2; Cs1÷s3,d2; Ds1÷s3,d2; ED2**, may be replaced by roof, niches or wall strips of reaction to fire class **A1, A2s1d0** respectively, with a width of at least **6.00 m**.

**A.10. 2.3.15.** In the case of existing buildings of different heights, fire walls shall, as a general rule, be provided on the tallest existing building over its full height or at least **8.00 m** above the lowest existing building. The provision of fire walls in the existing lower building is permissible if it is so constructed that fire cannot spread through the fire wall over a distance of **6.00 m** from the existing higher building, the existing lower part of the building shall meet the following conditions:

- the roof (terrace) must be gap-free, with a fire resistance of at least 1 hour (**REI60**) and a roof covering of reaction to fire class **A1, A2s1d0** or protected with materials of reaction to fire class **A1, A2s1d0** (poorly reinforced cement screed, tiles, gravel, slag, perlite mortar, etc.);

- existing rooms in that portion are equipped with automatic fire-fighting systems when the density of the heat load within them exceeds **840 MJ/m<sup>2</sup>**.

**A.10. 2.3.16.** Fire walls in existing buildings shall be positioned so as to avert the possibility of fire spreading from one fire compartment to another through unprotected gaps in the exterior walls at the inside corners of buildings or through the burning of existing combustible buildings in the vicinity.

**A.10. 2.3.17.** In cases where the fire walls are placed at the inner corners of existing L or U-shaped buildings the wells in adjacent external walls shall be arranged in such a way that the distance between them is at least reaction class to fire **4.00 m**. When functional gaps are provided in this section, they are considered to be protected if they are with fixed joinery **A1, A2s1d0** and armed jam, or with fire-resistant fastenings for 45 minutes (**EI45-C**), self-closing or automatically closing in the event of fire as described in Figure 276.

**A.10. 2.3.18.** The crossing of fire walls in existing constructions with metallic elements is permitted if measures are taken against the transmission of heat by conductivity (selection of judicious routes, removal of combustible materials, local protection of metal elements, etc.). Gaps around metal elements shall be designed to allow free expansion and shall be sealed with materials of reaction to fire class **A1, A2s1d0** or **A2s1÷s3,d0÷d1; Bs1÷s3,d0÷d1** or **Cs1÷s3,d0÷d1** ensuring a fire resistance of not less than 1 hour and 30 minutes (**EI90**).

**A.10. 2.3.19. (1)** The penetration of fire walls of existing constructions by electrical ducts, ventilation channels, conductors and cables shall be permitted only if the following conditions are met:

- clearances around electrical conduits, cables and conductors, etc., (including those laid in ducts), shall be sealed with materials of reaction to fire class **A1, A2s1d0**, ensuring fire resistance equal to that of the wall;
- ventilation ducts passing through the wall shall be non-combustible and the gap between the wall and them shall be sealed with materials of reaction to fire class **A1, A2s1d0**, fire resistant for at least 1 hour and 30 minutes (**EI90**);
- the passage of pipes and ventilation channels shall be carried out in such a way that it does not cause dislocations of parts of the walls due to their expansion under the effect of temperature increases;
- ventilation ducts are provided with shut-off systems, with automatic closing in case of fire, respectively fire dampers with fire resistance min. 1 1/2 hours (**EI90**);
- ensure the absence of ignition of combustible materials in the vicinity of ventilation ducts and metal ducts due to the heat transmitted through conductivity (appropriate ducts, thermal insulation, etc.).

**(2)** The penetration of fire walls in existing buildings which are extended by other new fire compartments (minimum one) shall be carried out in accordance with the provisions of the regulations (Art. 2.3.2.1.12. paragraph 1) and the penetration of fire protection partitions which limit propagation within fire compartments shall be carried out in accordance with the provisions of the regulations (Art. 2.3.2.1.12. paragraph 2).

#### **Protection of fire wall gaps**

**A.10. 2.3.20.** Firewalls in existing buildings are usually made without holes. Holes in these walls are allowed only when their activity or functionality requires their provision (for circulation, transport, surveillance, etc.) and they are protected in accordance with the provisions of this Annex. The total area of the permitted holes shall not exceed 25% of the firewalls in which they are formed.

**A.10. 2.3.21.** The circulation, transport, surveillance, etc. holes in fire walls and, where appropriate, fireproof floors in existing buildings must be protected by appropriate elements, which may be: doors, shutters, curtains, buffer rooms or fireproof openings, made in accordance with this Annex (only shutters or hatches shall be used on floors).

#### **Fire resistant doors, shutters and curtains**

**A.10. 2.3.22. (1)** Functional holes in fire walls in existing buildings, having a fire resistance of 1 hour and 30 minutes and equipped with self-closing or automatic closing devices in case of fire (**EI90-C**), depending on functional requirements.

**(2)** Functional holes in fire walls in existing buildings which are extended by other new fire compartments (minimum one) shall be made in accordance with the provisions of the regulations (Art. 2.3.2.2.2.1.).

**A.10. 2.3.23.** Fire doors and their closing systems shall meet the requirements of the technical adjustments and specific standards.

**A.10. 2.3.24.** Fire resistant shutters and fire resistant safety curtains are generally designed and manufactured in a similar way to fire doors.

#### **Fire buffers**

**A.10. 2.3.25.** Where, due to functional conditions, the gaps in fire walls cannot be protected by doors, shutters or fire curtains, the gaps may be protected by fireproof buffer rooms. Fireproof rooms in existing buildings shall be constructed in accordance with Figure 17 - Protected buffer room and the conditions of this Annex.

**A.10. 2.3.26.** The walls and floors of the fire buffer rooms shall be reaction class to fire **A1, A2s1d0** and fire resistant for at least 1 hour (**EI/REI60** walls and **REI60** floors). It is recommended that buffer rooms should be located adjacent to the fire wall of existing buildings and should be located towards spaces with lower thermal load density.

**A.10. 2.3.27.** Only holes strictly necessary for circulation shall be permitted in the walls of buffer rooms. Holes may be made in walls or floors to perform ventilation or smoke evacuation from buffer rooms.

**A.10. 2.3.28.** The circulation openings in the walls of existing fireproof buffer rooms shall be protected by doors which are fire-resistant for at least 45 minutes (**EI45-C**) and fitted, where appropriate, with self-closing devices or with automatic closing in the event of fire.

**(2)** The circulation openings in the walls of fire compartments in existing buildings which are extended by other new fire compartments (minimum one) shall be made in accordance with the provisions of the regulations (**Art. 2.3.2.2.3.1. and Table 14: Walls and floors in protected buffer rooms and gaps for functional circulation and discharge in walls of buffer rooms**).

### **Fireproof open drums**

**A.10. 2.3.29.** In exceptional cases, when, due to functional requirements, the protection of gaps in the fireproof walls of existing constructions cannot be achieved with doors, shutters, curtains or fireproof buffer rooms, open fireproof drums can be provided.

**A.10. 2.3.30.** The open fireproof drums in the existing constructions must have the same width as the protected gap, and the total length of at least **4.00 m**. Their placement can be done adjacent to the fireproof wall in the existing constructions or on both sides of it (according to Figure 26 - Open drum).

**A.10. 2.3.31.** The walls and floors of the fire-resistant open drum in the existing constructions must be made of materials of fire reaction class **A1, A2s1d0**, without holes and with a fire resistance of at least 1 hour (**EI/REI60** walls and **REI60** floors). In open drums, sprinklers or drains with automatic activation in case of fire must be provided, located one for every 1 m<sup>2</sup> of the horizontal surface of the drum.

### **Fire floors**

**A.10. 2.3.32.** Fire floors are horizontal or inclined construction elements that delimit closed volumes of existing tall and very tall buildings (existing fire compartments consisting of one to three successive levels with the unfolded area provided for in this annex), or separate functions with high fire risks.

**A.10. 2.3.33.** The fire-resistant floors in the existing constructions are made of fire reaction class **A1, A2s1d0** materials, with minimum 2-hour fire resistance (**REI120**) and without gaps or with strictly functional gaps, protected according to this annex.

### **Fire resistant elements and gap protection**

#### **Walls and gap protection**

**A.10. 2.3.34.** The minimum fire resistance and resistance conditions for fire resistant walls in existing constructions are laid down in this Annex as well as in the specialised technical regulations. In cases where no special conditions are laid down in the regulations, the reaction to fire and the fire resistance of these walls shall be determined by technical and economic documentation according to the level of fire stability of the construction, the density of the thermal load of the rooms and the separating role of the walls.

**A.10. 2.3.35.** *The functional circulation gaps in the fire-resistant walls of the existing constructions are protected according to the conditions specified in the regulations, in this annex and in the specialized technical regulations.*

#### **Floors and gap protection**

**A.10. 2.3.36.** *Floors can be fire retarding elements inside an existing fire compartment, only when they are fire resistant according to the provisions of this annex and have no gaps, or if the gaps made in them are protected with suitable closing elements.*

**A.10. 2.3.37.** *The conditions regarding the reaction to fire and the fire resistance of floors in existing constructions used to separate spaces with important functions and rooms with a high risk of fire, as well as the floors delimiting escape routes, are those provided in this annex and in specialized regulations.*

**A.10. 2.3.38.** *The functional gaps in the intermediate fire-resistant floors of existing constructions, which are elements that delay the spread of fire, are protected by fire-resistant elements, provided as the case may be, with self-closing or automatic closing devices in case of fire. In justified cases when it is not possible to create fire-resistant elements, the protection of the gaps can only be ensured by providing on the outline of the gap (under the floor), fire reaction class screens **A1, A2s1d0** and water curtains with automatic entry into operation in case of fire, or other technically approved protection systems.*

**A.10. 2.3.39.** *In existing buildings with an attic, of level **I, II** and **III** of fire stability, the gaps provided in the floors towards the attic are protected with closing elements resistant to fire for at least 30 minutes (**EI30**). The separation of the attic portions of the existing construction from its attics is achieved with fire reaction class **A1, A2s1d0** walls resistant to fire for a minimum of 2 hours (**EI/REI120**), and the functional communication gaps therein are protected with fire resistant doors for a minimum of 45 minutes, equipped with self-closing or automatic closing devices in case of fire (**EI45-C**).*

#### **Explosion resistant elements and gap protection**

**A.10. 2.3.40.** *The separation elements from the rest of the existing construction of the rooms with an explosion hazard (fire hazard categories A (**BE3a**) and B (**BE3b**)) will be fire reaction class **A1, A2s1d0** and explosion resistant.*

**A.10. 2.3.41.** *The separation of rooms or spaces with an explosion hazard from other hazardous rooms, hazard categories or uses in existing buildings, including buffer rooms, shall be provided by means of blast-resistant walls and ceilings constructed and constructed in accordance with this Annex.*

**A.10. 2.3.42.** *The design and dimensioning of blast-resistant walls shall be determined by calculation in such a way that they do not collapse under the effect of the overpressure produced in the rooms concerned, depending on the decompression surfaces provided (windows, panels, skylights, flying roofs, hatches, etc.).*

**A.10. 2.3.43.** *Explosion-proof walls shall also prevent the spread of fire from adjacent spaces to rooms with an explosion hazard, their fire resistance being determined by the heat load density of those rooms.*

**A.10. 2.3.44.** *The use of bays in explosion-resistant walls shall be permitted only in exceptional cases required by functional needs and only if they are protected in accordance with the provisions of this Annex.*

**A.10. 2.3.45.** *The penetration of blast-resistant walls by electrical conduits, conductors or cables shall be permitted only in cases of strict functional necessity, provided that the provisions of the standard and of this Annex are complied with.*

**A.10. 2.3.46.** Functional communication gaps in blast-resistant walls in existing buildings are protected by explosion-proof buffer chambers, and only in technically justified exceptional cases by open explosion-proof drums. The same shall apply to communication between rooms where there is a risk of explosion, where direct communication would impair safety or where the rooms are located in different fire compartments.

**A.10. 2.3.47.** Buffer rooms and open explosion-proof drums provided in blast-resistant walls in existing buildings shall be constructed in a similar way to fire walls, it being recommended that the walls and floors of such rooms be located towards less hazardous spaces. The doors of the explosion-proof buffer room shall be secured in addition to the requirements of Art. A.10. 2.3.28. and specific protective measures so as not to allow sparks capable of igniting the explosive mixtures in question.

**A.10. 2.3.48.** In buffer rooms and open explosion-proof drums separating spaces where explosive gas, vapour or dust releases occur, measures must be taken to prevent their passage from one side to the other during normal operation.

**A.10. 2.3.49.** For blast-resistant floors in existing buildings, the provisions relating to construction, dimensioning and other conditions laid down for blast-resistant walls (from Art. A.10.2.3.42. to Art. A.10.2.3.45.) shall be complied with. The floors and their supporting elements shall be sized and constructed in such a way that they are not thrown away from the blast of the explosion.

#### **Premises with explosion hazard category A (BE3a) and B (BE3b) of fire hazard**

**A.10. 2.3.50.** Buildings housing hazardous functions shall be constructed of materials and building elements of reaction to fire class A1, A2s1d0. In freestanding buildings with an explosion hazard it is recommended to use lightweight construction elements, reaction to fire class A1, A2s1d0, and the roof of these buildings must be without an attic.

**A.10. 2.3.51.** Rooms and spaces with an explosion hazard category A (BE3a) or B (BE3b) fire hazard, if they cannot be located outside buildings intended for other purposes, shall be separated from the rest of the building by elements of reaction to fire class A1, A2s1d0, explosion-resistant and, where appropriate, fire-resistant, suitably constructed and dimensioned in accordance with the provisions of the relevant technical regulations. The floors and their supporting elements shall be so constructed that they are not displaced by the blast.

**A.10. 2.3.52.** The practice of bays in explosion-resistant walls shall be permitted only in exceptional cases required by technological or functional needs and only if protected in accordance with the provisions of this Annex.

**A.10. 2.3.53.** The penetration of blast-resistant walls by electrical conduits, conductors or cables is permitted only in cases of strict necessity and provided that protective measures are taken to prevent the passage of combustible vapours, gases and dust.

**A.10. 2.3.54.** Explosion-proof floors must meet the conditions provided by the explosion-proof walls of the space concerned.

**A.10. 2.3.55.** Rooms and spaces at risk of explosion shall not have false ceilings and non-ventilated areas to facilitate the production of dangerous air concentrations by gases, vapours or fuel dust. In rooms with fuel dust release, the finish will allow easy cleaning of the surfaces.

**A.10. 2.3.56.** Rooms and enclosed spaces where there is a risk of explosion must have in the external walls or roof gaps for decompression in the event of an explosion with a total area of at least 0,05 m<sup>2</sup> per 1 m<sup>3</sup> of the volume of the room concerned. The adoption of a lower percentage is permitted on the basis of a supporting calculation, showing that the stability of the building is not thereby affected. Decompression gaps shall be located in the vicinity of the explosion sources, taking care that the blast effect outside the building does not affect neighbouring objects or public roads.

**A.10. 2.3.57.** Gaps intended for decompression in the event of explosion may be unclosed or closed. Fastenings, designed and constructed in such a way as to fail at the pressure caused by the explosion, may consist of: panels or portions of walls or roof of a lightweight type (removable or folding), windows and/or illuminators with a single non-wired glass failure at pressure not exceeding **118 daN/m.<sup>2</sup>**

**A.10. 2.3.58.** In spaces where explosive mixtures of air with gases, vapours or dust may occur, the surface wear layer of the floor coverings shall be made of materials which do not cause sparks which, upon impact, are not capable of initiating ignition of such explosive mixtures.

**A.10. 2.3.59.** In rooms and spaces where there is a risk of explosion, the joinery and its operating systems shall be so constructed or protected that, when operated, they do not produce sparks capable of igniting explosive mixtures.

**A.10. 2.3.60.** The delimitation of the areas in existing constructions to which the protection measures imposed by the spaces classified in categories A (BE3a) and B (BE3b) of fire danger are extended is done taking into account the possibility of the presence of air mixtures with gases, vapours or dust, in concentrations that present an explosion hazard, during normal operation and in the event of a breakdown of related utility installations.

### **Fire tight elements**

**A.10. 2.3.61.** Fire tight elements (E) shall be provided in the cases, conditions and in accordance with this Annex and the relevant regulations.

**A.10. 2.3.62.** In order for an item to be considered leak-proof, it must meet the standard requirements for tightness laid down in the technical regulations.

## **A.10. 2.4. CONSTRUCTIVE ASSEMBLIES**

### **General provisions**

**A.10. 2.4.1.** Existing buildings and building elements, in general, are designed and built in such a way that they do not favor the occurrence and propagation of fires.

**A.10. 2.4.2.** Combustible construction elements are recommended not to have internal gaps and their eventual internal gaps will be interrupted, as a rule, at no more than 3.00 m vertically and 6.00 m horizontally. Interruptions may be executed from the same material as the element. Gaps in vertical fuel elements must not communicate with those in horizontal fuel elements. Interruption of the continuity of the horizontal gaps must be done next to the partition walls and the vertical ones next to the floorboards. Interruption of the continuity of internal gaps is also mandatory for combustible cladding of walls and ceilings, but it does not refer to ventilation ducts, the space above the suspended ceilings with a role of ventilation as well as the spaces in the attic of existing buildings. The provisions of **Article 2.4.1.1.** and **Article 2.4.1.2.** of the legislation shall be complied with.

**A.10. 2.4.3.** The continuity of the combustible components of the roofs without a bridge must be interrupted at least near the settlement, expansion or seismic joints of the constructions, by interposing elements A1, A2s1d0, at least 1.00 m wide, or other accepted systems that ensure the limitation of combustion transmission.

### **Suspended ceilings**

**A.10. 2.4.4.** Combustible suspended ceilings must have interrupted continuity at least at the boundary of the walls of the room and in line with the construction's subsidence-dilation joints. The interruptions are made by non-combustible strips or gaps in the ceiling plane of at least 60 cm.

**A.10. 2.4.5.** In combustible or non-combustible ceilings suspended from floors, as a rule, the continuity of the gap between the ceiling and the floor is interrupted by diaphragms made of

materials of reaction to fire classes A1, A2s1d0, A2s1÷s3,d0÷d1; Bs1÷s3,d0÷d1 or Cs1÷s3,d0÷d1, or in technically justified cases by open drainage curtains/sprinklers, arranged not more than 25 m apart in two perpendicular directions. Exceptions are suspended ceilings that are not full (perforated, lamellar, honeycomb, grid or similar).

#### **Galleries, ducts**

**A.10. 2.4.6.** The installation in the same gallery, duct or scaffold of pipes or conveying systems for liquids or gases, the mixture of which may cause explosion or fire, is not permitted.

**A.10. 2.4.7.** The galleries, ducts and scaffolds intended for the transport of combustible substances, those passing over existing buildings and those constituting escape routes for persons shall be made of materials of reaction to fire class A1, A2s1d0.

**A.10. 2.4.8.** Enclosed galleries and ducts transporting combustible materials or containing combustible materials or elements shall be provided with possibilities for the evacuation of smoke and, where appropriate, hot gases.

**A.10. 2.4.9.** When ducts, conduits or cables pass through fireproof or fire-resistant walls and ceilings, appropriate measures shall be taken to seal the gaps around them with fire-resistant fittings in accordance with the provisions of this Annex.

**A.10. 2.4.10.** At the entrance to existing constructions of galleries, scaffolds and ducts of any kind, measures shall be taken to protect the gaps according to the nature of the materials from which they are made and those transported, the purpose of the spaces to which they lead and the fire protection role of the wall through which they pass. Where no special protective measures are required in this Annex, full doors shall be provided and, where justified by technical or functional conditions, the gaps may be protected by drainage curtains. Exceptions are open scaffolds, galleries and ducts made of elements of reaction to fire class A1, A2s1d0, carrying non-combustible materials, where gaps protection is mandatory only when passing through fire walls.

**A.10. 2.4.11.** In existing buildings of fire stability levels I, II and III, as a general rule, the walls of all vertical duct shafts shall be of reaction to fire class A1, A2s1d0, fire resistant for a minimum of 15 minutes (EI15), except for in the cases referred to in this Annex where higher resistances are required. Entrance hatches and doors in the walls of vertical piping ducting shafts must be made of materials A1, A2s1d0 or, where appropriate, reaction class to fire A2s1÷s3,d0÷d1; Bs1÷s3,d0÷d1 or Cs1÷s3,d0÷d1.

**A.10. 2.4.12.** Vertical duct and cable trunking, when passing through floor slabs, shall have the spaces between the ducts or cables enclosed with elements of reaction to fire class A1, A2s1d0, fire resistant for a minimum of 30 minutes (EI30), in all cases where the walls and hatches or their access doors are not fire resistant for a minimum of 30 minutes (EI30). When passing through existing fire compartmentation walls, the horizontal ducts are closed around the ducts and cables with materials of reaction to fire class A1, A2s1d0 with fire resistance equivalent to that of the penetrated element. Building elements and materials used for the protection, enclosure or concealment of installations and equipment shall be at least of reaction to fire classification Cs1÷s3,d0÷d1, with reaction to fire classification A1, A2s1d0 or A2s1÷s3,d0÷d1 being recommended; Bs1÷s3,d0÷d1.

#### **Baskets, tubes**

**A.10. 2.4.13.** Chimneys (or vents) and stoves shall be designed, constructed and insulated from combustible parts of the existing building in accordance with the relevant technical regulations so that they do not lead to fires due to the transmission of heat or the escape of hot gases, flames, sparks, etc.

**A.10. 2.4.14.** The heat release hoods of equipment, devices, appliances, etc. and their piping shall, as a general rule, be made of materials of reaction to fire classes A1, A2s1d0 and insulated from



adjacent combustible elements and materials. In functionally justified cases, they may be reaction class to fire **A2s1÷s3,d0÷d1**; **Bs1÷s3,d0÷d1** or **Cs1÷s3,d0÷d1** whether the profile technical regulations specify.

**A.10. 2.4.15.** Building elements separating the existing construction from the rest of the rooms and crematoria for rubbish will be made of materials of reaction to fire class A1, A2s1d0 resistant to fire for a minimum of 1 hour (EI/REI60) and doors resistant to fire for a minimum of 30 minutes (EI30-C). Chambers and crematoriums will be provided with smoke evacuation to the outside by natural - organized draught, minimum 1% of the area, or by mechanical ventilation system.

**A.10. 2.4.16.** Rubbish tubes shall be made of materials of reaction to fire class A1, A2s1d0 and access from the building to them shall be provided, as a general rule, from the outside (loggias, balconies), or through a buffer room separated from the rest of the building and the stairwell by walls of reaction to fire class A1, A2s1d0, fire resistant for a minimum of 1 hour (EI/REI60) and self-closing solid doors (-C), with the exceptions specified in this Annex.

### **Lifts**

**A.10. 2.4.17.** The shafts of lifts and vertical transport systems in general, including their machine rooms, shall be separated from the rest of the building by elements of reaction to fire class A1, A2s1d0 with fire resistance appropriate to the fire hazard(s), type of existing building and intended use, but not less than 1 hour for walls (EI/REI60) and floors (REI60). The shafts of fire lifts shall comply with their specific provisions.

**A.10. 2.4.18.** Material lifts and any vertical material transport system are not permitted in escape stairwells.

**A.10. 2.4.19.** For passenger lifts incorporated in stairwells or located in atria or arranged outside existing buildings, as well as those for access to open platforms, galleries or walkways, separation from the rest of the existing building by fire-resistant elements is not mandatory, as provided for in Art. A.10. 2.4.17.

### **Finishing**

**A.10. 2.4.20.** The finishing on the escape routes of persons shall, as a rule, be reaction class to fire **A1, A2s1d0**. Wooden floors and carpets up to 2 cm thick and foil finishes up to max. 0.5 cm thick, which shall be glued to a substrate of reaction to fire class A1, A2s1d0, subject to the exceptions laid down in this Annex. The reaction-to-fire performance classes of products used for interior finishing shall comply with Art. 3.1.4.11.

**A.10. 2.4.21.** When cladding fire-resistant walls of reaction to fire class A1, A2s1d0 with combustible materials, appropriate protective measures shall be taken, such as: treatment with fire-retardant substances, local interruption of the continuity of combustible materials, provision of automatic extinguishing systems, etc., in accordance with technical regulations.

**A.10. 2.4.22.** Combustible finishes and thermal or acoustic treatments mounted on fire reaction class A1, A2s1d0 fire resisting walls shall not create gaps more than 20 cm deep in relation to them.

**A.10. 2.4.23.** False ceilings, cladding, thermal and acoustic treatments, high floors and combustible finishes shall be mounted or protected from electrical appliances, lighting fixtures and in general any source of heating so that it is not possible to ignite them.

### **Curtain walls and glazed facades**

**A.10. 2.4.24.** Curtain walls used in perimeter closures of existing constructions, typically made of materials and building elements of reaction class to fire **A1, A2s1d0, A2s1÷s3,d0÷d1; Bs1÷s3,d0÷d1** or **Cs1÷s3,d0÷d1**, ensuring the fire resistance appropriate to the conditions of classification with the fire stability level of the existing construction.

**A.10. 2.4.25.** Curtain walls shall be so designed, built and constructed as to retard the spread of fire from one level to another, both through the exterior of the existing building (on the façade) and through the interior of the building.

**A.10. 2.4.26.** In order to delay the spread of fire through the exterior of the existing building (on the façade) the glazing of curtain walls and glazed façades shall be separated vertically by solid areas at least 1,20 m high, firetight for at least 30 minutes (E30). One of the solutions given in Art. 2.3.6.1.2 may be adopted to delay the spread of fire between building levels. ÷ **Article 2.3.6.1.7.**

**A.10. 2.4.27.** In front of and across the full thickness of the existing building's load-bearing floors, the space between the curtain wall and the floor shall be sealed with materials of reaction to fire class A1, A2s1d0, ensuring a minimum of 30 minutes fire resistance (E30) so as to delay the spread of fire through the interior. In all cases, thermo-foaming paints can also be applied for better fire performance.

**A.10. 2.4.28.** For delaying the spread of smoke and fire, in curtain walls that do not have full curtain walls of reaction to fire class A1, A2s1d0 with a fire resistance of at least 30 minutes (EI30) and glazed façades which do not comply with Art. **A.10. 2.4.26.** continuous screens of at least 50 cm in height of materials of reaction to fire class A1, A2s1d0, firetight for at least 30 minutes (E30) shall be provided under the load-bearing floors of the existing building. Where false ceilings are arranged at the lower limit of the screens, gaps (perforations) shall be provided in the ceilings through which smoke can penetrate behind the screen. The screens can be replaced with automatic drencher type installation to provide curtain protection.

**A.10. 2.4.29.** The curtain walls are anchored with steel elements to the existing building's structural strength which it encloses around the perimeter.

**A.10. 2.4.30.** Thermal insulation materials used in curtain walls will be reaction class to fire **A1, A2s1d0, A2s1÷s3,d0÷d1; Bs1÷s3,d0÷d1** or **Cs1÷s3,d0÷d1**.

### **Stairwell**

**A.10. 2.4.31.** The walls of enclosed stairwells in existing buildings of fire stability levels I and II shall, as a general rule, be of reaction to fire class A1, A2s1d0, fire resistant for a minimum of 2 hours and 30 minutes (EI/REI150) for buildings constructed before 01 January 2007 or fire resistant for a minimum of 3 hours (EI/REI180) for buildings constructed after 01 January 2007 and, where appropriate, explosion resistant, and in buildings of fire stability levels IV and V respectively, they may be of reaction to fire class A2s1÷s3,d0÷d1; **Bs1÷s3,d0÷d1** or **Cs1÷s3,d0÷d1**, with a fire resistance of 30 minutes or more (**EI/REI30**) and 15 minutes respectively (**EI/REI15**). Except as provided for in this Annex. The wall thickness behind the niches or grooves provided in the walls of stairwells shall provide a minimum fire resistance of 45 minutes (EI/REI45) for constructions of fire stability levels I, II and III and 15 minutes (EI/REI15) for those of fire stability levels IV and V respectively.

**A.10. 2.4.32.** The floors of existing buildings of fire stability levels I, II and III separating stairwells and their exit routes to the outside from the rest of the building shall be fire reaction class A1, A2s1d0 with a fire resistance of at least 1 hour (REI60). Existing buildings of fire stability levels IV and V shall comply with the conditions for fire stability classification.

**A.10. 2.4.33.** Beams, bridges and internal closed or open staircases shall be of reaction to fire class A1, A2s1d0 with a minimum fire resistance of 1 hour (R60) in buildings of reaction to fire classes I, II and III and at least of reaction to fire class **Cs1÷s3,d0÷d1** and a fire resistance of 45 minutes (R45) in buildings of reaction to fire class IV and 15 minutes (R15) in buildings of reaction to fire class V. Exceptions are those specified in this Annex.

**A.10. 2.4.34.** The protection elements of access openings to existing escape stairwells shall comply with the conditions laid down in this Annex/ in the standard.

## **Atrium**

**A.10. 2.4.35.** The provisions of this Annex concern enclosed atriums, covered with a width of at least  $\sqrt{7H}$  (where H is the smallest atrium height, but at least four existing construction levels).

**A.10. 2.4.36.** The construction of atriums which do not meet the minimum dimensioning conditions specified shall be permitted only if appropriate protective measures are taken to prevent the transmission of fire from one level to another by means of a flue effect (protection of wells with fire resistant elements, covers, balconies, water curtains, etc., as appropriate).

**A.10. 2.4.37.** For perimeter closures of atriums, as a rule, materials and construction elements of reaction to fire class A1, A2s1d0, resistant to fire for at least 15 minutes (EI15) are used, with the exception of some glazing materials (gaskets, sealants, mastics, etc.) which may be of reaction to fire class A2s1÷s3,d0÷d1; Bs1÷s3,d0÷d1 or reaction class to fire Cs1÷s3,d0÷d1.

**A.10. 2.4.38.** Where atriums are enclosed on the perimeter by glazed panels in relation to the rest of the existing building, such enclosures shall be such as not to encourage the spread of fire from one level to another. The speeds shall be vertically separated by areas full height of at least 1.20 m fire tight for 1 hour or more (E60). Full areas between display cases can be replaced on continuous horizontal floors (covers), reaction class to fire A1, A2s1d0 fire resistant at least 1 hour (REI60), and width of at least 1.20 m measured horizontally.

**A.10. 2.4.39.** The horizontal common circulation areas which are open to the atrium, shall be provided at their limit towards the atrium (under the floors) with continuous screens made of materials of reaction to fire class A1, A2s1d0, fireproof for at least 1 hour (E60), with a height of at least 50 cm, made similar to the provisions of Art. A.10. 2.4.28., they may not be replaced by automatic sprinkler or drencher.

**A.10. 2.4.40.** If for functional reasons walls are provided for separating atriums from the rest of the existing construction, they shall be reaction class to fire A1, A2s1d0 with fire resistance corresponding to heat load density, but not less than 1 hour (EI/REI60). Their speeds will not exceed reaction class to fire 30 % from the surface of the wall and will be A1, A2s1d0 fire resistant for at least 15 minutes (EI15), unless otherwise specified in this Annex.

**A.10. 2.4.41.** Equipment (fixed or mobile) of materials may be used in atriums reaction class to fire A1, A2s1d0, A2s1÷s3,d0÷d1; Bs1÷s3,d0÷d1 or Cs1÷s3,d0÷d1, and the density of the heat load will not exceed 420 MJ/m<sup>2</sup>. In determining the density of the heat load, the highest level of the atrium bounded by the walls (outside the ground floor) shall be taken into account.

**A.10. 2.4.42.** Skylights and domes covering atria can be made with structure reaction to fire class A1, A2s1d0 and glazing reaction to fire class A1, A2s1d0, A2s1÷s3,d0÷d1; Bs1÷s3,d0÷d1 or Cs1÷s3,d0÷d1 which shall not be taken into account in determining the level of fire stability of the existing construction.

**A.10. 2.4.43.** In existing atrium constructions, it is not recommended that spaces of high fire risk be arranged without separation of the atrium. Where provided, however, (for commercial activities, permanent exhibitions with combustible exhibits and similar with a heat load density above 840 MJ/m<sup>2</sup>), these spaces shall be compulsorily equipped with automatic fire signalling and fire-fighting systems.

**A.10. 2.4.44.** Deposits of combustible materials and/or substances which are not separated from atriums by fire resistant elements corresponding to the density of the thermal load are not permitted.

## **Storage rooms**

**A.10. 2.4.45.** Storage rooms for solid combustible materials and substances with an area of more than 36 m<sup>2</sup> located in existing buildings for other purposes shall, as a rule, be separated from the

rest of the existing building by walls and floors of reaction to fire class A1, A2s1d0 with fire resistance corresponding to the thermal load density (according to Art. A.10. 2.3.2. and Table 146: Fire resistance of walls in existing buildings), unless otherwise specified in this Annex. Existing storage buildings shall be constructed in accordance with specific provisions.

**A.10. 2.4.46.** Functional communication gaps in the storage compartment elements specified in Art. A.10. 2.4.45. it shall be protected with elements appropriate to the provisions of this Annex. Smoke evacuation in the event of fire in these stores is mandatory and shall be provided by devices which open automatically in the event of fire, with a free area of at least 1% of the floor area, or by properly designed, distributed and dimensioned mechanical smoke extraction systems.

#### **Facilities for utility installations**

**A.10. 2.4.47.** Fire water pumping stations, generators constituting back-up electrical sources supplying fire protection devices, fire hydrants and the like shall be separated from the rest of the building, as a general rule, by walls of reaction to fire class A1, A2s1d0, without gaps and with a fire resistance limit of at least 3 hours (EI/REI180) and 1 hour 30 minutes (REI90), with easy access from outside. Communication with the rest of the building of these functions is also permitted only from a common corridor through a door with a fire resistance of at least 1 hour and 30 minutes (EI90-C), equipped with self-closing devices or automatic closing in case of fire. The provisions of the specific technical regulations will also be taken into account.

**A.10. 2.4.48.** Central heating boiler rooms shall be separated from the rest of the existing building by walls and floors of materials reaction class to fire **A1, A2s1d0** with fire resistance according to specific regulations but not less than 1 hour 30 minutes (walls) **EI/REI90** and floors **REI90**). In the separating walls, communication gaps with the existing construction are allowed, protected with doors of reaction to fire class A1, A2s1d0, fire resistant for at least 15 minutes (EI15).

**A.10. 2.4.49.** Rooms for fans, filters, plenums and cyclones through which gases, vapours, dust or combustible waste are conveyed shall be functionally separated from the rest of the existing building by partitions of reaction to fire class A1, A2s1d0 with appropriate fire resistance, but at least 1 hour (walls EI/REI60 and floors REI60). Access to these rooms, as a rule, must be from the outside or from rooms without fire risks or hazards (with a heat load density of less than 105MJ/m<sup>2</sup>).

### **A.10. 2.5. ESCAPE ROUTES IN CASE OF FIRE**

#### **General provisions**

**A.10. 2.5.1.** In existing buildings, existing fire compartments, rooms and other constructed spaces, escape routes shall be provided so that, in the event of fire, persons can reach the outside at ground level or road surfaces in the shortest possible time and in complete safety. For functional circulations associated with places where the presence of people occurs by chance are visited not more than 8 times per shift for checks, as well as for smoking rooms or sanitary rooms, the conditions laid down for escape routes are not mandatory.

**A.10. 2.5.2.** The traffic routes provided for the normal operation of existing buildings shall also ensure the evacuation of persons in the event of fire. Specially designed evacuation routes shall only be provided when the functional ones are insufficient or cannot satisfy the conditions of fire safety.

**A.10. 2.5.3.** The provisions of the Annex constitute mandatory conditions for the design and completion of escape routes of persons from existing constructions whose interior finish is made from traditional materials: stone, ceramics, glass, wood, metal. In the case of finishing materials which, compared to wood, ignite more easily, spread flames on the surface more quickly or give off more smoke or gases, the project shall take additional protective measures in accordance with the technical specifications of the products concerned.

**A.10. 2.5.4.** Fire escape routes are considered to be open circulation routes which, fulfilling the conditions laid down in this regulation and annex, provide escape through doors, corridors, clearances, halls or vestibules at ground level or on carriageways as follows: directly; through evacuation stairwells; through terraces; balconies; loggias, escape passages.

**A.10. 2.5.5.** Escape routes may also be considered to be those passing through rooms or spaces in existing civil (public) or production buildings, in accordance with and subject to the conditions of the regulations and this Annex.

**A.10. 2.5.6.** Escape routes in the event of fire are generally not: lifts; passageways through fire doors that can be locked in the closed position or through locked doors during normal operation of the existing building; passageways intended for train sets carrying dangerous goods; galleries, tunnels, etc. through which substances with the risk of fire, explosion, poisoning, asphyxiation by steam with a pressure greater than 1 atm are transported or conveyed.

**A.10. 2.5.7.** Doors locked during normal operation may constitute a second means of egress from a portion of the building or the entire existing building, except for crowded rooms, if:

- their construction and dimensions comply with the provisions of this Annex;
- they are fitted with lockable, easily operable keyless opening systems which can be operated from the area to be evacuated or are provided with toughened glass panels of a size to permit the passage of escape flows and with parapets of not more than 0.40 m. In the case of glass panels, appropriate means of escape and indicators shall be provided. The safety glass panels constructed in such a way as to be easily recognisable and positioned next to the doors, suitably marked and so arranged as to be easily recognisable.

**A.10. 2.5.8.** The second escape route may also consist of one or more windows (with movable mesh min. 75 cm wide and 1.00 m clear height), with the parapet not more than 1.50 m above ground level or a terrace through which discharge can be made at ground level, for:

- a) above-ground rooms containing not more than 50 persons;
- b) basement or semi-basement rooms where there are not more than 30 persons on the whole level and fixed stairways are provided inside to parapets higher than 1,20 m. In such rooms, hatches of at least 80 cm x 80 cm with fixed access ladders inside, providing direct escape from the outside, are also permitted.

In existing buildings which are high, very high and crowded rooms, the second escape route shall not be covered by windows.

**A.10. 2.5.9.** The composition of the construction elements and finishes used on the escape routes shall be determined in accordance with the provisions of the Rules and this Annex.

**A.10. 2.5.10.** Escape routes must be distinct and independent, so established as to ensure their judicious distribution, the possibility for persons to easily recognise the route to the outside and smooth movement. Escape routes must not lead outwards through places where movement may be blocked in the event of fire by flames, smoke, thermal radiation, etc.

#### **Number of escape routes**

**A.10. 2.5.11.** In existing buildings, existing fire compartments or existing building sections which are independent in terms of movement, as a general rule, persons should have access to at least two escape routes, which as far as possible lead in opposite directions. The second escape route may consist of external windows or hatches if they ensure the safe evacuation of persons as specified in the Annex, Art. A.10. 2.5.8.

**A.10. 2.5.12.** The provision of a single escape route is allowed when, according to the design, a maximum of 20 persons can be accommodated simultaneously on each level - irrespective of the

length of the escape route, as well as in cases where the number of persons is greater but the length of the escape route is within the permitted value for dead-end corridors, depending on the level of fire stability, fire risk, type of existing building, and use, as specified in this Annex. In existing tall buildings, very tall buildings and crowded rooms, and in the situations set out in the regulations and this Annex, a minimum of two escape routes are mandatory.

**A.10. 2.5.13.** The design and dimensions of the escape routes, the length of the escape routes, the routes and the number of escape flows shall ensure smooth and unobstructed movement as specified in the Annex.

### **Composition of escape routes**

#### **Doors**

**A.10. 2.5.14.** Doors used on escape routes shall be of a typical type on hinges or pivots.

**A.10. 2.5.15.** Doors which may jam due to malfunction of their auxiliary mechanisms, as well as sliding, guillotine, tilting, etc., are not permitted on escape routes. Exceptions are doors for not more than 5 persons capable of evacuating themselves and the cases provided for in this Annex. Folding doors and revolving doors (with niches that can be easily folded) may be used on escape routes only if ordinary pedestrian doors (on hinges) or panes of toughened glass in accordance with Art. A.10. 2.5.5.

**A.10. 2.5.16.** The opening of doors on the evacuation route shall, as a general rule, be in the direction of outward movement of persons, except for doors through which not more than 30 able-bodied persons are evacuated and in the cases provided for in this Annex.

**A.10. 2.5.17.** When opened, escape doors shall not impede each other or hinder evacuation.

**A.10. 2.5.18.** Thresholds higher than 2,5 cm shall not be permitted in front of escape doors. If they are required, they shall be sloped to the floor. In the situations permitted by this Annex, escape doors in other large doors may have thresholds as low as possible, but not more than 40 cm high.

#### **Interior staircases**

**A.10. 2.5.19.** Existing internal stairways may be enclosed (located in their own stairwells) or open (located in lobbies, vestibules, atria, etc.) in accordance with the provisions of this Annex. Escape staircases shall, as a general rule, run in the same vertical direction from the last level for which they provide escape to the level of the exit at ground level or to external road surfaces, or to a terrace from which escape can be continued to ground level. Persons entering the stairway house shall be able to reach, without leaving it, to the level of the exit to the outside. Exceptions are stairways within residential accommodation and stairways which are interrupted and where escape from the point of interruption to ground level can be continued safely via terraces or other stairways or corridors with direct access to the outside. The direct connection between two interrupted internal stairways shall be via a common landing.

**A.10. 2.5.20.** In order to prevent the entry of smoke into escape routes and the spread of fire from one level to another, stairways, whether or not they are taken into account in the evacuation, shall as a general rule be separated from the rest of the existing building by walls and floor plans constructed in accordance with this Annex. Open internal staircases shall be permitted only in the cases and under the conditions specified in this Annex. The enclosure of stairways shall be such that access by persons to at least two escape stairways, where such stairways are required, is possible without passing through the house of either stairway.

**A.10. 2.5.21.** Storey lobbies into which escape staircases open freely may be assimilated to stairwells if they are intended solely for circulation or waiting purposes and if they are separated from the rest of the existing building as provided for in the relevant stairwells.

**A.10. 2.5.22.** The interior walls of stairwells may only have access openings to existing building levels. For the lighting of stairwells, storey lobbies and corridors, gaps may be provided only under the conditions permitted by this Annex and adequately protected.

**A.10. 2.5.23.** Access openings to escape stairwells shall be protected in accordance with the provisions of the regulations, as a general rule by: solid or single-glazed or reinforced doors, or fire-resistant watertight doors, or buffer rooms, in the situations permitted in accordance with the annex and properly constructed and equipped. In all cases, access doors to stairwells shall be provided with self-closing or automatic closing systems, as appropriate, except those to existing residential buildings which are not tall or very tall buildings.

**A.10. 2.5.24.** Escape stairwells of above-ground levels are recommended not to be continued in the basement of existing buildings, and where this is not possible or justified, it shall be permitted only under the conditions laid down in Art. A.10. 2.5.25. to **Article A.10 2.5.28.**

**A.10. 2.5.25.** Where the basements in question contain only rooms with a low fire risk and have a heat load density resulting from the furniture, finishes and materials housed of not more than 210 MJ/m<sup>2</sup>, the escape stairways continued to the basement shall be separated in the same way as in the upper storeys, unless otherwise provided in the annex.

**A.10. 2.5.26.** In cases where underground rooms have windows with a total area of min. 1/100 of the floor area and accommodate similar uses (functions) as those on the upper levels or technical spaces, storerooms, or maintenance workshops occupying not more than 1/4 of the floor area of the level, stairwells continued to the basement shall, as a general rule, be separated from the lower levels in the same way as the upper levels and access openings shall be protected by fire doors of at least 45 minutes' duration (EI45-C), fitted with self-closing devices or automatic closing devices in case of fire.

**A.10. 2.5.27.** The access ramp to the basement may be arranged in the continuation of the stairwell above ground if it is separated from the ramps of the levels above ground by fire-resistant walls minimum 2 hours and 30 min (EI/REI150) for buildings constructed before 01 January 2007 or fire-resistant walls minimum 3 hours (EI/REI180) for buildings constructed after 01 January 2007 and fire-resistant floor slabs minimum 1 hour (REI60), it being recommended that the basement evacuation is carried out independently of the levels above ground of the building. The basement may functionally continue with the stairwell of the upper storeys, as a general rule, through a 1-hour fire door (E60-C) at ground floor level, unless otherwise specified in this Annex.

**A.10. 2.5.28.** Above-ground stairways for the escape of persons may have direct (non-separated) ramps to the basement when they provide access to rooms and spaces functionally linked to those above ground and if these functionalities are separated from the rest of the basement with other uses by walls of reaction to fire class **A1, A2s1d0** fire resistant for a minimum of 3 hours (EI/REI180) and firetight doors 1hour (E60-C) or 1 h 30' (E90-C) for rooms with a heat load density of **840 MJ/m<sup>2</sup>** or higher).

**A.10. 2.5.29.** There shall be no working, storage or other (non-circulation) areas in the escape stairwells and no natural gas pipes for technological uses, pipes for combustible liquids or pipes for collecting waste or other materials shall be introduced. Installations that do not present a fire or explosion hazard may be located in stairwells if they do not reduce the clearance required for evacuation. In the case of the location of waste pipes or other materials in separate adjacent rooms communicating with the stairway enclosures, appropriate measures shall be taken to prevent the entry of smoke and fire into the stairway enclosure.

**A.10. 2.5.30.** Stairwells are recommended to be naturally lit directly from the outside.

**A.10. 2.5.31.** The natural lighting of the stairwells can be done indirectly, through gaps protected with elements resistant to fire for at least 30 minutes (EI30), from corridors or rooms with a heat load density lower than 105 MJ/m<sup>2</sup>.

**A.10. 2.5.32.** In existing buildings of fire stability levels I, II and III, lighting by artificial light alone is normally permitted if, in the event of fire, smoke evacuation from stairwells is provided by means of automatic and manually operated devices with a cross-section of at least 5% of the horizontal floor area of the stairwells, but not less than 1 m<sup>2</sup>, and if an artificial lighting system is in operation at all times. An exception is made for the situations listed in this Annex.

**A.10. 2.5.33.** Lighting gaps in the exterior walls of staircases shall be protected against thermal radiation resulting from fires in existing buildings, installations or storerooms in their vicinity, or even in portions of the same existing building situated at distances less than those permitted under the provisions of Art. A.10.2.2.2 and Table A.10.4.

**A.10. 2.5.34.** Open internal escape staircases shall be permitted in the cases and under the conditions laid down in the Annex, depending on their intended use, and when they ensure the escape of not more than two successive levels.

**A.10. 2.5.35.** Escape stairwells, shall have exits at ground level or exterior roadway surfaces as follows:

- a) directly to the outside;
- b) through the lobby or vestibule;
- c) through a corridor not more than 10 m long, with direct access to the outside or via a hallway or vestibule;
- d) through a protected escape or escape tunnel with a maximum length of 200 m, with access to the outside and consisting of elements of reaction to fire class A1, A2s1d0 with fire resistance corresponding to the thermal load density of the adjacent rooms, but not less than 2 hours for walls (EI/REI120) and 1 hour for floors (REI60). Doors in tunnel walls or protected decking shall be fire resistant 1 hour (EI60-C) to rooms with a heat load exceeding 420 MJ/m<sup>2</sup> and equipped with automatic self-closing devices in the event of fire and fire resistant for 1 hour and 30 minutes (EI90-C) to rooms with heat load above 840 MJ/m<sup>2</sup> and equipped with automatic self-closing devices in the event of fire.

The lobby, vestibule or corridor through which access to the outside is provided shall be separated from adjoining internal rooms and corridors on the ground floor by walls of reaction to fire class A1, A2s1d0 with a fire resistance of at least 1 hour (EI/REI60), with the exception of atrium type lobbies for which specific protection measures are provided.

**A.10. 2.5.36.** The ground floor corridors, which provide access to the outside of the escape staircases, can communicate freely with supervised cloakrooms, reception rooms for the public and functionally necessary spaces (trade, food, meetings, etc.). All escape staircases on the upper levels may have access to the outside via a common corridor. Open staircases, where permitted in the Annex, may have access to the outside through the spaces in which they are located. Stairwell doors provided for the purpose of ensuring escape in the event of fire at ground level or on a carriageway surface, but not used in the current functional circulation, shall be provided with glazed security panels in accordance with Art. A.10. 2.5.7.

**A.10. 2.5.37.** Beams, floors and steps of internal escape ladders in existing buildings shall meet the reaction-to-fire conditions laid down in this Annex.

**A.10. 2.5.38.** The inclination of escape staircase ramps, the surface and shape of steps and landings must be such as to permit the smooth and safe movement of persons in accordance with the provisions of the specific regulations.

**A.10. 2.5.39.** Stairs with curved (helical) ramps are considered escape routes only in the part of the ramp where the minimum width of the step is 18 cm and the maximum width is 40 cm, if the steps



have the same shape and dimensions throughout the staircase. The regulatory conditions will be complied with.

**A.10. 2.5.40.** Staircases with balanced steps may be considered as escape routes, only for a single user escape flow, if they meet the construction and sizing conditions laid down in the standard, annex and specialist regulations.

**A.10. 2.5.41.** In existing buildings of three or more storeys, it shall be possible for hoses to be lifted up to the place where they are to be used, through stairwell windows located on accessible facades (provided that no awnings or protruding construction elements are provided under these windows to prevent hoses from being lifted up). Where staircases have no windows, gaps at least 20 cm wide shall be provided in the same vertical plane in the floor or between the stringers. Exceptions are stairwells with fixed dry columns (pipes) for water supply in case of fire.

**A.10. 2.5.42.** Escape staircases can be replaced in all cases by inclined plans, if they meet the provisions of the standard and technical regulations relating to staircases (closure, fire resistance, dimensioning, etc.). The slopes of inclined planes shall not exceed 1: 10 (1: 8 at building exits) and provided with a wear layer to prevent people from slipping.

### **Open external ladders**

**A.10. 2.5.43.** Open external escape staircases may be located independently outside the existing building or attached to it on up to three sides. They may replace the necessary internal escape staircases or constitute a continuation thereof, if they are made of materials of reaction to fire class **A1, A2s1d0**, with a fire resistance of at least 15 minutes (**R15**) and if:

- they comply with the provisions on sizing of escape stairs;
- are protected in accordance with Article. **A.10. 2.5.44.**

**A.10. 2.5.44.** Open external escape staircases shall be so located or protected that movement cannot be blocked by flames or smoke produced - in the event of fire - in the existing building for which they provide escape, or by damage to pipes carrying steam, combustible liquids or gases, acids or toxic substances, etc., located within **3,00 m** of the staircase. Stairways shall be considered satisfactorily protected by locating them in front of solid portions of walls of reaction to fire class **A1, A2s1d0** and a minimum of 15 minutes fire resistance (**EI15**), which in horizontal projection exceed a minimum of **3,00 m** of the stairway gauge, or by screening the stairway with fire resisting elements with a minimum of 15 minutes fire resistance (**EI15**) from wall openings (except for the stairway access openings) and the abovementioned ducts which are less than **3,00 m** apart. Access open exterior stairwells shall be protected by 15-minute firetight doors (**E15-C**) equipped with self-closing systems or by baffled passageways as required by functional needs.

### **Terraces and patios**

**A.10. 2.5.45.** Circulating terraces, balconies and loggias constituting escape routes shall be of reaction to fire class **A1, A2s1d0** with the exception of combustible insulation mounted on concrete slab - fire resistant for at least one hour (**REI/R60**) and protected against blockage of circulation by falling ignited building elements. Terraces less than 6.00 m wide and balconies used for escape must be protected with full screens against the effects of fires on lower floors or in the vicinity. Portions of non-circulating terraces may also be used for evacuation if they meet the above conditions and measures are taken to direct, organise and protect the established evacuation routes.

**A.10. 2.5.46.** Inner courtyards and open spaces between existing buildings may be considered for the evacuation of persons in the event of fire if they are of sufficient width for the passage of the number of flows resulting from the calculation, but not less than **3,50 m**.

**A.10. 2.5.47.** Evacuation through terraces, balconies, loggias, interior courtyards or through spaces between existing buildings can only be done if circulation cannot be blocked due to flames or smoke.

### **Sizing of escape routes**

#### **Calculation criteria**

**A.10. 2.5.48.** The calculation of the escape routes (for more than five persons) consists of determining the required gauges and fixing the length of the routes so as to ensure rapid discharge from the existing construction during the normal time in line with the expected escape lengths.

**A.10. 2.5.49.** The evacuation of people from the existing building is considered to be orderly, in the form of streams (rows of people sitting one behind the other), which flow through the escape routes to the outside of the building.

**A.10. 2.5.50.** The number of flows to be provided for the evacuation of persons and the gauges necessary for the passage of evacuation flows shall be calculated as specified in the Annex.

**A.10. 2.5.51.** The width of staircase ramps shall, as a general rule, be determined according to the level from which the greatest number of flows originate, without accumulation of flows coming from different levels, with the exceptions set out in the Annex.

**A.10. 2.5.52.** If there are other levels with a smaller number of persons above the level which determines the dimensioning of the staircase ramps, the width of the stairway above it may be smaller, being dimensioned according to the largest number of persons of one of those levels.

**A.10. 2.5.53.** For staircases with branched ramps, the width is calculated for the main ramp. The width of each branch ramp shall be at least 60% of the width of the main ramp.

**A.10. 2.5.54.** The width of each escape stair bridge shall not be less than the width of the widest ramp it intersects. On staircases with branched ramps the width of the central landing shall be at least equal to that of the widest branched landing.

**A.10. 2.5.55.** Where the external escape routes of the other levels are common to those of the ground floor, the width of the exits to the outside (doors at ground level) must ensure the passage of the total number of persons determined by summing:

- the number of persons coming via the internal staircase from the most populated level of the existing building;
- 60 % of the number of persons on the ground floor of the existing building;
- 60 % of the number of people coming via the internal stairs from the basement.

#### **Determination of escape flows**

**A.10. 2.5.56.** The number of flows to be ensured for the evacuation of persons shall be determined with the relationship:

$$F = N/C$$

where:

$F$  = number of flows;

$N$  = the number of people who have to pass through the escape route

$C$  = the normal discharge capacity of a flow;

The results in the relation are rounded up to the next whole number.

**A.10. 2.5.57.** The number of persons (*N*) for which escape routes are calculated is the maximum simultaneous capacity of persons, established by design per level and total existing construction.

**A.10. 2.5.58.** The discharge capacity of a stream (*C*) shall be determined according to the type, purpose and fire risk of the existing construction as specified in the Annex.

**A.10. 2.5.59.** For existing buildings in which a large number of persons may be accommodated at the same time, the number of escape flows resulting from the calculation for the external doors of the building may be reduced by a percentage, with the written consent of the beneficiary (with his assumption of liability), as follows:

- with **10 %** for those requiring **10-20** evacuation flows;
- with **20 %** for **21-30** flows;
- with **25 %** for more than **30** flows.

### **Dimensions of the escape routes**

**A.10. 2.5.60.** The clear width required to pass the evacuation streams, in relation to their number, shall be at least:

- **80 cm** for a flow;
- **1.10 m** for two flows;
- **1.60 m** for three flows;
- **2.10 m** for four flows;
- **2.50 m** for five flows;

Intermediate widths are considered valid for the passage of the lower number of flows.

**A.10. 2.5.61.** Width of escape routes for more than **50** by persons, it shall not be reduced in the sense of outward movement, even if it is greater than that resulting from the calculation.

**A.10. 2.5.62.** The gross (unfinished) dimensions of corridors and staircases, as well as those of communication openings in their walls (doors), shall be determined in such a way that the free space required for the passage of the number of flows is not reduced by more than **10 cm** over a maximum height of **2.10 m** from floor level (by projections of walls, frames, linings, ducts, open doors or windows, interior finishes, installations, etc.). The width of staircase ramps is measured up to the handrails, (which as a rule should not reduce the clearance gauge). Reduction of **10 cm** only applicable in height.

**A.10. 2.5.63.** In the walls of corridors and staircases for the evacuation of more than **50** persons, recesses with a parapet (lower limit) more than **1.20 m** above the floor or with their upper edge not more than **90 cm** from the floor are permitted.

**A.10. 2.5.64.** The width of corridors, ramps and stairwells which are used for the evacuation of more than **50** persons shall not be reduced by doors or windows which open into them and may be blocked in the open position by persons moving to exit the existing building. Exceptions are windows whose parapet is at least **2.00 m** above the level of the floor or steps in front of them.

**A.10. 2.5.65.** Open doors to escape stair landings must not reduce the calculated escape stair gauge. In front of the doors of passenger lifts, as a rule, the width of stair landings should be at least **1.60 m**. Exceptions are cases where the landing doors of lifts are sliding or close by rotating in the same direction as the outward escape flow, in which case the width of the landing may be reduced to **1,20 m**.

**A.10. 2.5.66.** As a rule, the clear passage width of an escape door should not exceed **2.50 m**. If the width of the door is greater, it shall be divided by solid recessed uprights into clearances not exceeding **2.50 m** in width. Exceptions are doors whose width is at least twice the width required for the passage of exhaust flows and monumental doors.

**A.10. 2.5.67.** *The width of the ramp of escape ladders, as a rule, shall not be greater than 2.50 m between walls and handrails or between two handrails of the same ramp. Where the width of the ramp is greater, it is divided by intermediate railings into spaces of max. 2.50 m width. It is not mandatory to provide intermediate handrails at ramps:*

*a) used to climb to reach the exit;*

*b) with a width at least twice the width required for exhaust flows, or are monumental staircases.*

**A.10. 2.5.68.** *The clear height on the escape routes must be at least 2.00 m. For attics or basements, this height may be a minimum of 1.90 m and attic and basement doors may have a clear height of 1.80 m.*

### **Length of escape route**

**A.10. 2.5.69.** *In determining the length of the escape route, account shall be taken of the route taken in the axis of the escape route from the starting point to an exit to the outside, or to an enclosed or open escape staircase or protected clearance, taking into account the position of the various items of equipment or fixed objects to be avoided, while complying with the permitted performance levels in the axis.*

**A.10. 2.5.70.** *When determining the length of the escape route, no account shall be taken of distances travelled:*

*a) on the escape stairs and from their base to the outside as well as inside protected decks;*

*b) inside rooms in which the permissible outlet length for corridors is not exceeded.*

**A.10. 2.5.71.** *The determination of the theoretical time required to evacuate users in accordance with the provisions of this Annex shall be carried out by possibly relating the permissible evacuation lengths to the average speed of travel, taken as 0.4 m/sec. horizontally and 0.3 m/sec. vertically (stairs, slopes).*

### **Marking of escape routes**

**A.10. 2.5.72.** *Escape routes must be marked with signs in accordance with technical regulations.*

**A.10. 2.5.73.** *In existing buildings with more than two storeys above ground level, in the case of lowering the escape stairs below ground level, under the conditions referred to in Art. A.10. 2.5.24., provision shall be made for directing the escape circulation to the outside exit.*

**A.10. 2.5.74.** *The technical economic documentation of existing constructions shall include, where appropriate, evacuation plans, indicating and marking the routes to be followed in the event of fire.*

## **A.10. 2.6. UTILITY INSTALLATIONS FOR EXISTING BUILDINGS**

**A.10. 2.6.1.** *Utility installations related to existing buildings (hydro, electrical, heating, ventilation, conditioning and similar) shall be designed and executed in such a way that they do not contribute to the occurrence and propagation of fires, in accordance with the provisions of this Annex and the relevant regulations.*

**A.10. 2.6.2.** *Heating systems and installations shall be determined according to the fire risk, the intended use, the level of fire stability and the size of the existing buildings, with open fires in spaces (rooms) presenting a high fire risk and those with an explosion hazard being prohibited. The electrical utility installations relating to existing buildings shall be appropriate to the fire risk, the intended use and the environment, in accordance with their specialised technical regulations.*

**A.10. 2.6.3.** Rooms and spaces in which combustible substances are released shall be provided with installations for the evacuation of gases, vapours, dusts and powders as they are released, so as to avert the possibility of their accumulation in dangerous quantities. In the construction of ventilation or conditioning systems and installations, care shall be taken to reduce the possibility of explosive mixtures forming and the propagation of fire through ventilation ducts and to use materials, components and equipment appropriate to the fire hazard, in accordance with the relevant regulations.

**A.10. 2.6.4.** Separation of installations and ventilation systems of spaces and rooms of fire hazard categories A, B (BE 3a,b) and C (BE 2) is also mandatory in the situations specified in this Annex and the technical regulations. The evacuation through the same ventilation (conditioning) system or installation of substances that, in a mechanical mixture or chemical combination, can cause ignition or explosion is prohibited.

**A.10. 2.6.5.** The ventilation (conditioning) systems and installations of rooms where combustible substances are stored, processed or handled, crowded rooms and rooms with equipment and, as the case may be, equipment of great value or special importance, as well as those with high risks of fire, will be independent of the other ventilation (conditioning) systems or installations of the existing construction.

**A.10. 2.6.6.** Inside the ventilation (conditioning) ducts, no combustible liquid or gas pipes or electrical circuits may be installed.

**A.10. 2.6.7.** It is not advisable to cross fire or fire resistant subdivision elements through ventilation ducts. Where such crossings are absolutely necessary, measures shall be taken to avert the spread of fires in neighbouring compartments, in accordance with the provisions of the Rules and the Annex.

#### **A.10. 2.7. ACCESS, INTERVENTION AND RESCUE ROUTES**

**A.10. 2.7.1.** In order to ensure the conditions of access, intervention and rescue in case of fire to existing buildings and installations, the necessary roads or free strips of land, properly arranged for the access of fire-fighting equipment and fire engines, shall be provided. It is not mandatory to ensure road circulation (roads) at cabins, tourist refuges, existing constructions at altitude (mountains), outbuildings, etc. as well as existing constructions in the D (reduced) importance category.

**A.10. 2.7.2.** The traffic routes (roads) provided will ensure access without obstacles and over the shortest possible distances to existing constructions, storages of combustible substances, parking and fuelling points for special vehicles and water sources.

**A.10. 2.7.3.** Traffic and access routes (roads) to existing buildings and premises, which have level crossings with railway lines on which wagons may be stationed, shall be provided with a second crossing possibility, so that access for fire engines is possible at all times.

**A.10. 2.7.4.** Enclosed courtyards on all sides of existing multi-storey buildings are not recommended. In cases where such courtyards are provided, however, where fire brigades do not have access, it is necessary to ensure that rescue possibilities for persons in the existing building are provided through windows or gaps in the facades of the existing building accessible to the fire services and fire units, appropriately marked so as to be easily recognisable in the event of fire.

**A.10. 2.7.5.** Existing uncovered courtyards with an area of more than 600 m<sup>2</sup> and enclosed on all sides by buildings, situated at ground level or at a difference in level of less than 50 cm from adjacent roadways or at a difference in level of less than 50 cm from such roadways, must be provided with roadway accesses for fire-fighting vehicles with a minimum width of 3.80 m and a height of 4.20 m. For the existing inner courtyards mentioned, located at differences in level greater than 50 cm (without road access), only access for intervention personnel (pedestrian crossings) is provided, with a minimum width of 1.50 m and a height of 1.90 m.

**A.10. 2.7.6.** Existing armoured buildings will have access facilities for fire service and fire brigade personnel through openings in the exterior walls, protected by panels that can be easily removed from the outside and appropriately marked.

**A.10. 2.7.7.** For the intervention of fire brigade personnel directly from the outside, the perimeter enclosures of existing buildings with curtain walls shall be marked with glazing panels through which access can be gained to horizontal common circulation (halls, vestibules, corridors, etc.) or to rooms with permanent access to common circulation. The externally visible marking of at least one access on each storey of the existing building is mandatory on storeys up to 28.00 m above the roadway on all facades accessible to fire engines.

**A.10. 2.7.8.** Existing buildings enclosed by curtain walls will be provided with roadway circulation in front of the marked façade panels for the access of the fire brigade.

**A.10. 2.7.9.** Within existing buildings, the routes of intervention of fire service personnel and fire units shall be established, laid out and appropriately marked so as to be easily recognisable in the event of fire.

#### **A.10. 2.8. THE PROVISION OF INTERVENTION MEANS AND THE FIRE SERVICE**

**A.10. 2.8.1.** In order to ensure verification, surveillance and intervention in the event of fire, the design shall determine the level of equipment for the fire service according to the category of importance, size, destination and fire vulnerability of the existing construction.

**A.10. 2.8.2.** The equipment and fitting of the fire service must meet the practical requirements of ensuring the fire safety of the existing construction, in accordance with the specific regulations, depending on fire risks and fire safety scenarios.

**A.10. 2.8.3.** In the technical documentation, the fire service will have the space necessary for its permanent operation established, usually on the ground or lower upper ground levels of the existing building.

**A.10. 2.8.4.** The fire service will be equipped with lighting and communication means, specific apparatus and protective equipment, appropriate to the fire risks and the type of existing construction, ensuring the necessary reserves.

**A.10. 2.8.5.** Existing constructions shall be equipped with technical means of extinguishing appropriate to the specific fire risks, specifying in the documentation the type and quantity required, including reserves for immediate replacement.

## **SECTION II**

### **EXISTING CIVIL (PUBLIC) BUILDINGS**

#### **CHAPTER 3**

#### **PERFORMANCE COMMON TO EXISTING CIVIL (PUBLIC) BUILDINGS**

##### **A.10. 3.1. FIRE RISK AND FIRE STABILITY LEVEL**

###### **Fire risks**

**A.10. 3.1.1.** Existing rooms, spaces and civil (public) buildings will have fire risks, as provided for in **Article A.10.2.1.1** up to **Article A.10.2.1.3** of this annex.

**A.10. 3.1.2.** Depending on the fire hazards determined, the fire safety conditions and performance levels permitted in Part I of this Annex "Provisions common to all buildings" and in this Part shall be provided. Fire safety assessments drawn up in accordance with the relevant regulations may, in

justified situations, adopt compensatory protective measures to ensure fire safety conditions and permissible performance.

**A.10. 3.1.3.** Fire risks are mandatory in the technical documentation.

#### **Fire stability level**

**A.10. 3.1.4.** Existing civil (public) buildings will have the level of fire stability and mandatory specified in the design documentation. The minimum conditions that the existing building has to meet in order to be classified in a certain level of fire stability are those laid down in Art. A.10.2.1.8. to Art. A.10.2.1.14.

### **A.10. 3.2. LOCATION AND FIRE COMPLIANCE**

#### **Location**

**A.10. 3.2.1.** Existing civil (public) buildings, whether freestanding, semi-detached or clustered in accordance with the general recommendations, shall be located in fire-safe areas in the vicinity at the permissible safety distances (Art. A.10.2.2.1. to Art. A.10.2.2.3.), or shall be subdivided as specified in the Annex.

**A.10. 3.2.2.** Existing buildings for persons who cannot evacuate themselves and those for objects or equipment of particular importance, are not recommended to be pooled with constructions of a different purpose. Existing tall and very tall buildings shall not be merged with buildings having another purpose.

**A.10. 3.2.3.** In the case of combining several functions in an existing civil (public) building, the functions shall be adequately separated, as a rule, by walls and floors of materials of reaction to fire class A1, A2s1d0, fire resistant as specified in the Annex.

#### **Fire compliance**

**A.10. 3.2.4.** Compliance shall take into account the provisions of Art. A.10.2.2.4. to Art. A.10.2.2.10. and specific ones. The permissible constructed areas of fire compartments for existing above-ground civil (public) buildings are those specified in Table 147.

**A.10. 3.2.5.** Between the number of levels of the existing above ground buildings, their use, fire stability level and their capacity (number of persons), the following correlations will be observed:

**a)** in existing buildings of fire stability levels **I and II**, irrespective of their capacity, the number of storeys above ground shall not be limited (except for those with crowded rooms of fire stability level **II**);

**b)** in existing buildings with fire stability **III, IV and V**, the number of storeys above ground shall be limited according to the intended use and the number of persons accommodated as specified in Table 148.

**A.10. 3.2.6.** In existing civil (public) buildings with fire stability level I and II, the attic is allowed (the creation of a level built in the volume of the bridge) if the elements in the load-bearing structure of the roof and the furnished rooms are non-combustible and separated from the rest of the bridge with resistant walls on fire for at least 3 hours (EI/REI180). In existing buildings with fire stability level III, IV and V, the attic (built-up level in the volume of the bridge), is allowed under the conditions of compliance with the provisions of Table 148.

**A.10. 3.2.7.** The storage of explosion dangerous goods and substances in existing civil (public) buildings, as well as the location of workshops where such materials are used, shall be permitted only in the cases mentioned and in compliance with the provisions of the Rules and of this Annex.

**A.10. 3.2.8.** By complying with the existing civil (public) constructions, it will be ensured, as far as possible, that the spaces with a high risk of fire are separated from the areas accessible to the public, carrying out the necessary protective measures according to the Rules and the annex.

### **A.10. 3.3. CONSTRUCTIVE ASSEMBLIES**

**A.10. 3.3.1.** Existing civil (public) constructions shall be constituted in accordance with the provisions of **Chapter A.10. 2.4. Constructive compositions** of this Annex, fulfilling their common and specific performances. It is recommended to use materials and construction elements of reaction to fire class A1, A2s1d0.

**A.10. 3.3.2.** Where materials and components of fuel classes A2s1÷s3,d0÷d1 may be used according to the provisions of this Annex; **Bs1÷s3,d0÷d1** or **Cs1÷s3,d0÷d1** or **Ds1÷s3,d0÷d1** or **A2s1÷s3,d2**; **Bs1÷s3,d2**; **Cs1÷s3,d2**; **Ds1÷s3,d2**; **ED2**, depending on the specific conditions and fire safety scenarios developed, as well as their role in the event of fire, appropriate fire safety protective measures shall be provided in accordance with this Annex.

**A.10. 3.3.3.** By their construction and design, the construction elements used must not spread fire easily.

### **A.10. 3.4. LIMITING THE SPREAD OF FIRE AND SMOKE**

**A.10. 3.4.1.** Partition walls provided to limit the spread of fire within a fire compartment are recommended to be fire reaction class A1, A2s1d0 and fire resistant for a minimum of 2 hours (EI/REI120) cross-sectioning the existing building (walls that can be offset vertically). These walls, as a rule, shall be located no more than:

- **110 m** far from the existing buildings of fire stability levels **I, II and III**;
- **70 m** far from the existing buildings with fire stability level **IV and V**;

In existing loft buildings whose roof is made of materials of reaction to fire class **A2s1÷s3,d0÷d1**; **Bs1÷s3,d0÷d1** or **Cs1÷s3,d0÷d1** or **Ds1÷s3,d0÷d1** or **A2s1÷s3,d2**; **Bs1÷s3,d2**; **Cs1÷s3,d2**; **Ds1÷s3,d2**; **ED2**, those walls shall also separate the volume of the attic.

**A.10. 3.4.2.** In existing civil (public) buildings, doors provided in corridors intersecting fire walls and those in partitions referred to in Art. A.10.3.4.1., may be firetight for a minimum of 30 minutes (E30-C) in accordance with this Annex having self-closing or automatic closing devices in case of fire, as required by the functional and fire escape requirements.

**A.10. 3.4.3.** High fire risk functions in existing buildings shall be separated by **A1, A2s1d0** walls and floors with fire resistance according to the Annex and communication gaps adequately protected. Walls and floors separating different functions with medium fire risk, combined in an existing civil (public) building must be fire reaction class A1, A2s1d0 with a fire resistance of at least 2 hours for walls (EI/REI120) and 1 hour for floors (REI60). In existing buildings with fire stability reaction class to fire **IV and V** walls and floors may be **A2s1÷s3,d0÷d1**; **Bs1÷s3,d0÷d1** or **Cs1÷s3,d0÷d1** fire resistant for 30 minutes (**EI/REI30** walls and **REI60** floors). The separation elements of low-risk functions shall comply with the requirements for fire stability classification.

**A.10. 3.4.4.** The minimum conditions to be met by certain walls and floors in existing (public) civil buildings which are not high, very high or with busy rooms are set out in Table 149. Regardless of the type and destination of the existing building, the separation of escape corridors from adjacent sanitary facilities (bathrooms, showers, toilets) may be carried out in accordance with the standard conditions for compliance with the fire stability level.

### **A.10. 3.5. ESCAPE ROUTES IN CASE OF FIRE**

**A.10. 3.5.1.** Existing public (civil) buildings shall have the necessary number of escape routes for the use of users in the event of fire, suitably arranged, constructed and dimensioned, in accordance with the provisions of this Annex (Article **A.10.2.5.1**. to Article **2.5.74**).



*In existing civil (public) buildings that are not tall or very tall, stairwell access openings may have full or glazed doors to corridors, floor vestibules and hallways if the following conditions are met:*

*a) their walls and floors (corridors, vestibules, hallways) have the same fire resistance as stairwells;*

*b) between corridors, vestibules or hallways and adjacent rooms, including other stairwells, full doors are provided;*

*c) any windows for the indirect lighting of corridors, hallways or vestibules in the walls separating them from adjacent rooms shall be protected in accordance with Art. A.10.2.5.31.*

**A.10. 3.5.2.** *Open internal escape staircases are permitted in existing public (civil) buildings if they serve to evacuate users of not more than two levels.*

**A.10. 3.5.3.** *Stairways located in the atrium volume and not enclosed in their own stairwells do not constitute fire escape routes. An exception is made for atria of up to four storeys in height of the existing building, where it is considered that only one escape flow can pass through the open staircase in the atrium, even if the width of the ramps provides for more than one flow.*

**A.10. 3.5.4.** *The maximum permissible lengths of escape routes in existing civil (public) buildings are those laid down in the specific provisions for existing civil (public) buildings, and for atriums according to Art. A.10.3.5.5. and Art. A.10.3.5.6. The evacuation capacities taken into account for existing civil (public) buildings are specified in Table 150.*

**A.10. 3.5.5.** *Common horizontal circulation routes open to the atrium (platforms, overhangs, etc.) may constitute escape routes for persons in adjoining rooms where the length of the escape route, i.e. the distance they have to travel, does not exceed the maximum permitted values in Table 50: Escape lengths on horizontal common circulation routes open to atria from their doors to an escape staircase (measured in the centreline of the routes), depending on the fire stability of the building.*

**A.10. 3.5.6.** *For sleeping rooms of hotels, homes, hospitals, dwellings and the like located adjacent to atriums, the maximum permissible values of escape routes in horizontal common circulations open to the atrium shall be reduced by 50 % with regard to the provisions set out in Table 50: Escape lengths on common horizontal circulations open to atriums.*

**A.10. 3.5.7.** *The doors of rooms opening into horizontal common circulation open to the atrium shall be designed and equipped in accordance with the provisions of the regulations relating to communication between rooms with different uses and escape routes.*

**A.10. 3.5.8.** *Opening of doors on the escape route of more than 30 valid persons must be in the direction of outward travel.*

### **A.10. 3.6. UTILITY INSTALLATIONS RELATED TO EXISTING CIVIL (PUBLIC) BUILDINGS**

**A.10. 3.6.1.** *The equipment of existing civil (public) buildings with utility installations shall be provided in accordance with the provisions of the relevant regulations.*

**A.10. 3.6.2.** *As a rule, thermal power stations may be located in civil (public) buildings provided that they are separated from the rest of the building by walls and floors of reaction to fire class A1, A2s1d0 and fire resistant for a minimum of 3 hours (EI/REI180) for walls and 2 hours (REI120) for floors, with access from an interior corridor, with the exceptions set out in the Annex.*

**A.10. 3.6.3.** *Location of fuel liquid tanks with flammable vapour temperature below 55 °C in existing civil (public) buildings, the quantities and protective measures set out in the Annex and in the relevant technical regulations shall not normally be permitted, except for the supply of thermal power stations and generating sets related to the existing building.*

**A.10. 3.6.4.** For heaters using combustible gases or liquids, specific technical and safety rules shall be complied with in accordance with the relevant technical regulations.

**A.10. 3.6.5.** Kitchens and hot food preparation areas shall be insulated from publicly accessible spaces, as a general rule, by fire reaction class A1, A2s1d0, fire resistant walls and floorboards for a minimum of one hour (EI/REI60 for walls and REI60 for floorboards) and the connecting doors shall be sealed for a minimum of 15 minutes (E15-C). Exceptions are the situations specified in the Annex.

**A.10. 3.6.6.** Kitchens and hot food preparation areas freely located in existing public spaces shall be enclosed by screens at least 50 cm below the ceiling made of materials of reaction to fire class A1, A2s1d0 with a minimum fire resistance of 15 minutes (EI15-C) and secured in a depression from the rest of the space in which they are located. In kitchens located in existing high, very high or crowded buildings, hoods shall be provided with special extinguishing installations.

**A.10. 3.6.7.** Mechanical ventilation and air-conditioning systems shall be designed and constructed so as to prevent the spread of fire and smoke into existing civil (public) construction.

**A.10. 3.6.8.** Ventilation ducts shall be made of materials of reaction to fire class A1, A2s1d0 or according to specific regulations.

**A.10. 3.6.9.** Electrical installations will be designed and constructed according to specific regulations and no drainage routes will be used.

### **A.10. 3.7. ACCESS, INTERVENTION AND RESCUE ROUTES**

**A.10. 3.7.1.** Existing civil (public) constructions shall have access, intervention and rescue routes, suitably sized and marked so that they can be used by personnel intervening in the fire.

**A.10. 3.7.2.** The external intervention paths will allow the easy access of fire brigade intervention vehicles, being marked and kept permanently clear. As a rule, they will ensure the intervention of at least one facade of the existing building, except for the situations specified in this annex.

**A.10. 3.7.3.** Inside the existing civil (public) constructions, fire brigade intervention routes, properly marked, will allow easy access to the main functional circulations (horizontal and vertical), as well as to spaces with fire risk or danger.

### **A.10. 3.8. INTERVENTION EQUIPMENT, FIRE BRIGADE SERVICE**

**A.10. 3.8.1.** Existing civil (public) buildings shall be equipped with fire extinguishers, providing a 6 kg portable powder extinguisher or equivalent for a maximum built-up area of 250 m<sup>2</sup>, but a minimum of 2 extinguishers per level of the existing building. The portable extinguishers must contain the extinguishing agent and quantity appropriate to the hazard class, foreseeable in the space.

**A.10. 3.8.2.** All intervention means with which existing civil (public) buildings are equipped and endowed will be easily accessible to staff and maintained in working order.

**A.10. 3.8.3.** In premises and rooms with a high fire risk or where dangerous substances are present (parking lots, trade, etc.), where appropriate, portable fire extinguishers shall also be provided in accordance with specific regulations.

**A.10. 3.8.4.** The organisation of the civil fire service, its equipment and endowment, shall be determined in accordance with the regulations, function of destination, vulnerability, and the level of equipment of the existing building.

**A.10. 3.8.5.** As a rule, existing civil (public) buildings shall have civil fire brigades when the maximum simultaneous capacity exceeds 500 persons and when the fire-fighting appliances with which they are equipped are not automatically operated.

**A.10. 3.8.6.** Existing civil (public) buildings equipped with automatic fire signalling and extinguishing systems will have fire brigades in place to supervise and operate the specific systems only.

**A.10. 3.8.7.** The number of fire service personnel is determined according to the necessary operational activities, the fire risk, the importance and vulnerability of the existing building, the effects of the fire, etc. according to the specific technical regulations.

### **A.10. 3.9. SMOKE DISCHARGE (SMOKE EXTRACTION) AND HOT GASES**

**3.9.1.** In general, spaces accessible to the public shall be so constructed and protected as to be free from smoke in the event of fire, subject to the specific conditions laid down in this Annex relating to smoke extraction (Chapter 9 - Section V - Smoke extraction (smoke extraction) and hot gases).

**A.10. 3.9.2.** Storage rooms for solid combustible materials and substances with an area greater than 36 m<sup>2</sup> and escape stairwells and buffer rooms without natural daylight shall be provided with smoke extraction devices representing at least 1% of the respective area of the storage room and 5% of the constructed area of the stairwell (but at least 1 m<sup>2</sup> per stairwell), or with mechanical smoke extraction systems.

**A.10. 3.9.3.** Common horizontal circulation routes, including buffer rooms and escape stairwells of enclosed underground levels intended for public use, shall be provided with independent smoke evacuation (smoke extraction) systems from the above ground levels.

**A.10. 3.9.4.** Ensuring the evacuation of smoke from atriums in the event of fire is mandatory. This shall be achieved by means of self-opening devices ensuring a free area of at least 1% of the area of the highest level of the atrium delimited by the walls - excluding the one on the ground floor - or by means of a properly designed and dimensioned mechanical smoke exhaust system. In both cases, air inlet possibilities are provided at the bottom of the atriums. The automatic actuation of the smoke evacuation devices shall be coupled with manual controls at the level of the external accesses to the atrium and at the pumping service. When the atrium is under constant surveillance, the smoke evacuation (smoke extraction) can only be operated manually.

**A.10. 3.9.5.** In order to limit the possibility of smoke spreading to the upper floors, when the height of the atrium is greater than 28.00 m, it is recommended that the levels in the upper half of the atrium be insulated from the atrium by fire reaction class A1, A2s1d0, fire resistant for a minimum of 15 minutes (EI15).

**A.10. 3.9.6.** All rooms and spaces open directly to the atrium (commercial shops, exhibitions and the like requiring smoke extraction according to the regulations) shall have smoke extraction facilities in case of fire (smoke extraction) independent of the atrium.

**A.10. 3.9.7.** Non-partitioned rooms with a floor area greater than 10,400 m<sup>2</sup> shall be provided with smoke and hot gas exhaust systems to limit the spread of fire in accordance with (Art. A.10.3.9.36. to Art. A.10.3.9.45.).

### **A.10. 3.10. PERFORMANCE OF SOME FUNCTIONS (DESTINATIONS)**

#### **Existing residential buildings**

**A.10. 3.10.1.** Existing residential buildings, individual (family) or collective, detached or semi-detached or grouped within the fire compartments permitted for existing civilian buildings, shall be located at safe distances, or shall be partitioned as specified in the Annex.

**A.10. 3.10.2.** Existing residential buildings shall be made of materials and construction elements that ensure compliance with the general and specific provisions of the standard and the conditions of correlation between the level of fire stability, the number of levels and the fire compartment area, in accordance with Art. A.10.3.2.4. and Art. A.10.3.2.5.

**A.10. 3.10.3.** Building elements of existing residential buildings grouped or merged within a fire compartment shall comply with the conditions laid down in Table 151, and for non-grouped elements the conditions laid down in Art. A.10.2.1.9. appropriate to the level of fire stability provided. Domestic enclosures may be made in the subsoil or middle of existing dwelling buildings, provided that they are used only for permitted materials and substances (no high fire risk) and that appropriate protective measures are provided.

**A.10. 3.10.4.** Existing individual buildings (family) ground floor or ground floor-storey and possibly attic, can be made of materials and construction elements of fire reaction class **A2s1÷s3,d0÷d1; Bs1÷s3,d0÷d1** or **Cs1÷s3,d0÷d1** or **Ds1÷s3,d0÷d1** or **A2s1÷s3,d2; Bs1÷s3,d2; Cs1÷s3,d2; Ds1÷s3,d2; ED2**, provided that the correlation established in Art. A.10. 3.2.5. of the Annex.

**A.10. 3.10.5.** In existing individual (family) dwellings made of combustible materials (under the conditions allowed by the Annex), it is recommended to use finishes of materials of reaction to fire class A1, A2s1d0 in kitchens and other open fire spaces.

**A.10. 3.10.6.** Car garages attached to or incorporated in individual residential buildings shall be separated from them by partitions of reaction to fire class A1, A2s1d0, with a fire resistance of at least 1 hour (EI/REI60).

**A.10. 3.10.7.** Collective housing blocks with flats and/or studio flats shall be made of materials and construction elements corresponding to the conditions of correlation between the level of fire stability, the number of levels and the fire compartment area, established in Art. A.10.3.2.5. Existing residential blocks falling into the category of tall or very tall buildings shall comply with the specific provisions for them.

**A.10. 3.10.8.** Existing multi-family residential buildings are considered high-rise buildings if they have more than 11 storeys above ground. Above the limit level, a single storey is permitted, occupying a maximum of 50% of the building's floor area and comprising only lift car rooms, communal laundry and ironing rooms and technical spaces. Existing high-rise residential buildings with a height of more than 50 m - measured according to the provisions of the regulations - fall into the category of very high-rise buildings.

**A.10. 3.10.9.** In very tall existing buildings, the walls and floors separating the residential flats from adjoining spaces and common circulation routes must be fire reaction class **A1, A2s1d0** fire resistant for at least 1 hour (EI/REI60 walls and REI60 floors), and the functional communication gaps between the apartments and the horizontal common circulation shall be protected by fire-resistant and smoke-tight doors for at least 30 minutes (EI30-C5Sa) in the closed position, provided with self-closing devices.

**A.10. 3.10.10.** The permissible reaction to fire and fire resistance conditions for walls bounding escape routes in existing residential buildings are given in Table 152 (if they are not tall or very tall buildings).

**A.10. 3.10.11.** Escape staircases for people on the first floor and possibly the attic of individual dwellings as well as in duplex or triplex apartments (regardless of the type of existing residential building) may be made of materials of reaction to fire class **A2s1÷s3,d2; Bs1÷s3,d2; Cs1÷s3,d2; Ds1÷s3,d2; ED2** and unenclosed in their own stairwells.

**A.10. 3.10.12.** Staircases for the escape of upper levels may be continued in the basement of existing residential buildings under the conditions laid down in Art. A.10.2.5.24. Exceptions to the provisions of Art. A.10.2.5.26., the secondary stairways of residential buildings, the access openings of which are separated by normal solid doors from basements in which there are only rooms for household annexes (irrespective of the area of the windows).

**A.10. 3.10.13.** Doors at the entrance to existing residential buildings that are not tall or very tall can be opened inwards.

**A.10. 3.10.14.** Apartment doors to stairwells shall be of the type specified in the Annex, with no requirement for self-closing devices in residential buildings not falling into the category of tall or very tall buildings.

**A.10. 3.10.15.** The evacuation capacity (C) of a stream (number of persons) at existing residential buildings is 90 persons.

**A.10. 3.10.16.** The maximum permissible route length for escape routes in existing residential buildings which do not fall into the category of tall or very tall buildings is given in Table 56: Escape lengths in above-ground dwelling buildings of normal heights.

**A.10. 3.10.17.** Balanced staircases are permitted for the evacuation of persons from existing residential buildings where it is necessary to provide a single evacuation flow as specified in the Annex, and the balancing of steps at the first flight of stairs (at ground level).

#### **Existing administrative buildings**

**A.10. 3.10.18.** Existing administrative buildings (headquarters for central and local administrations, prefectures, town halls, financial-banking, trade unions, offices, etc.) shall be designed and constructed in accordance with the Annex, taking into account the specific conditions.

**A.10. 3.10.19.** Depending on the purpose and type of construction, existing administrative buildings shall be designed to ensure that the correlation between the fire stability level, the fire compartment area and the number of storeys is met, in accordance with Art. A.10.3.2.4. and Art. A.10.3.2.5.

**A.10. 3.10.20.** In the case of incorporation of administrative premises/rooms in existing civilian public buildings with other functions (housing, education, tourism, commerce, etc.) the general fire safety provisions and specific provisions shall be respected.

**A.10. 3.10.21.** In all cases, underground levels (basements, semi-basements) shall be separated from the rest of the existing construction by fire reaction class A1, A2s1d0 floor slabs with a fire resistance of at least 2 hours (REI120), including their supporting elements, unless more stringent conditions are laid down in the regulations.

**A.10. 3.10.22.** Monumental staircases can be open throughout the height of the existing administrative building if measures are taken to limit the spread of fire and smoke and closed staircases are provided to ensure evacuation.

**A.10. 3.10.23.** It is recommended to provide direct natural lighting of stairwells.

**A.10. 3.10.24.** Depending on the level of fire stability of the existing building (which is not high or very high), the walls separating the common circulation and escape routes from the rest of the existing building shall also meet the fire performance requirements of Table 153.

**A.10. 3.10.25.** Ramps and bridges of stairs or inclined planes shall comply with the conditions of Art. A.10.2.4.32. and Art. A.10.2.4.33.

**A.10. 3.10.26.** The evacuation capacity (C) of an evacuation flow (F) is a maximum of 80 persons, with the exception of crowded rooms and high and very high buildings where specific measures are observed.

**A.10. 3.10.27.** The maximum permissible lengths of the escape routes of existing administrative buildings (excluding crowded rooms and tall and very tall buildings) are given in Table 60: Exhaust lengths in above ground administrative buildings of ordinary heights.

#### **Existing buildings for trade**

**A.10. 3.10.28.** Existing commercial buildings (shopping centres, shops, supermarkets, closed markets, catering, services, car service and similar), in addition to the common measures laid down, will also comply with specific provisions.

**A.10. 3.10.29.** Existing commercial buildings, whether free-standing or incorporated in existing buildings for other purposes, shall meet the conditions of correlation between the fire stability level, the number of storeys and the fire compartment area laid down in Art. A.10.3.2.4. and Art. A.10.3.2.5. and in the case of incorporation of commercial spaces or rooms in existing civil (public) buildings with other functions, the general provisions of the Annex and the specific provisions shall be complied with.

**A.10. 3.10.30.** Underground commercial spaces, located in their own existing buildings or in the basements of existing above-ground buildings with other functions, shall be designed and built in accordance with specific technical regulations.

**A.10. 3.10.31.** As a general rule, enclosed underground commercial spaces with an area greater than 300 m<sup>2</sup> shall be provided with smoke evacuation (smoke extraction) in accordance with the provisions of the regulations, including the enclosed escape routes associated with them.

**A.10. 3.10.32.** Hand storage for a maximum of 20% of the products displayed for sale, associated with commercial premises, may be separated by furniture from the areas accessible to the public, but shall not exceed 10% of the area of the sales space on the level.

**A.10. 3.10.33.** The retail level stores will be separated from publicly accessible sales areas by walls of reaction to fire class A1, A2s1d0 fire resistant for a minimum of 2 hours (EI/REI120) and floors of reaction to fire class A1, A2s1d0 fire resistant for a minimum of 1½ hours (REI90). Functional circulation gaps in these partitions shall be protected by fire-resistant doors for a minimum of 45 minutes (EI45-C), fitted with self-closing or automatic closing devices in the event of fire.

**A.10. 3.10.34.** The storerooms of commercial stores incorporated in existing buildings with other uses shall be partitioned off from the rest of the existing (other use) building with vertical and horizontal building elements of reaction to fire class A1, A2s1d0 with fire resistance corresponding to the thermal load density, according to Art. A.10.2.3.2.

**A.10. 3.10.35.** The main storage rooms for combustible products in buildings or commercial premises incorporated in existing constructions for other purposes shall be partitioned with fire-resistant elements in relation to the rest of the existing construction, corresponding to the heat load density, and in accordance with the provisions of the Annex.

**A.10. 3.10.36.** In existing commercial buildings, open internal staircases between a maximum of three successive levels are permitted, provided an enclosed escape stair is also provided. Regardless of their number, open staircases shall constitute a single escape route for persons.

**A.10. 3.10.37.** Depending on the level of fire stability of existing commercial buildings, the walls of escape routes for persons (corridors, hallways, enclosed staircases) shall meet the requirements of Table 154. Where they are crowded rooms or are in existing tall or very tall buildings or are underground, their specific measures shall be respected.

**A.10. 3.10.38.** Ramps and bridges of stairs or inclined planes shall comply with the conditions of Art. A.10.2.4.32. and Art. A.10.2.4.33.

**A.10. 3.10.39.** The evacuation capacity (C) of an evacuation flow (F) is max. 70 persons except in crowded rooms.

**A.10. 3.10.40.** The maximum permitted lengths of escape routes (except for existing buildings with crowded rooms and existing tall and very tall buildings) are given in Table 64: Exhaust lengths in above-ground commercial buildings of ordinary heights.

**A.10. 3.10.41.** The escape routes of underground commercial spaces shall, as a general rule, be independent of those of the above-ground levels used for other purposes, and communication between them shall be permitted only through buffer rooms under the conditions laid down in the Annex.

**A.10. 3.10.42.** To estimate the number of people having access to public spaces which typically represent at least 2/3 in the area of the existing shop (existing shopping centre), the following densities will be taken into account:

**a)** For shops, a person shall be considered to be a person on:

- 1m<sup>2</sup>, ground floor;
- 2 m<sup>2</sup>, basements and 1st and 2nd floors (facing the ground);
- 5 m<sup>2</sup> at the other levels of the basement and floors.

**b)** For existing shopping centres (with a minimum floor area of 500 m<sup>2</sup>) one person per 5 m<sup>2</sup> is considered, regardless of level.

**A.10. 3.10.43.** Commercial premises are considered to be at high risk of fire, and when equipped with automatic water sprinklers, they are considered to be at medium risk of fire.

**A.10. 3.10.44.** Internal escape staircases of existing commercial constructions are recommended to be illuminated naturally.

**A.10. 3.10.45.** Commercial premises falling within the category of crowded rooms will also comply with their specific conditions.

**A.10. 3.10.46.** Explosive or violent burning products (ammunition, fireworks, etc.), liquefied gases and combustible liquids with a flammable vapour temperature below 28 °C are not allowed in commercial premises. Exceptions are cosmetics and pharmaceutical products packaged in bottles and shops specially designed for the sale of dangerous products.

#### **Existing health buildings**

**A.10. 3.10.47.** Existing health buildings (hospitals, polyclinics, dispensaries, children's homes, old people's homes, etc.) will meet the common conditions laid down in the regulations as well as in the specific regulations.

**A.10. 3.10.48.** Existing health buildings shall meet the correlation conditions between fire stability level, built-up area and number of levels, as specified in Art. A.10.3.2.4. and Art. A.10.3.2.5., recommending the use of fire resistant building elements.

**A.10. 3.10.49.** In existing health care buildings where people who cannot move around on their own are hospitalised, staircases with curved ramps or with balanced steps are prohibited, and open staircases are only allowed between two successive levels.

**A.10. 3.10.50.** The stairwells of existing health buildings will be naturally lit as far as possible.

**A.10. 3.10.51.** In situations where the evacuation of persons from the existing building can only be carried out with accompanying persons (by stretcher or trolley), the minimum clearances of the escape routes shall be as follows:

**a)** Crossing widths for 2 streams:

- corridors and flights of stairs or inclined planes, minimum 2.20 m;
- floors/gradients of ladder or sloping planes, minimum 2.60 m;
- platforms in front of passenger lifts for patients transported by stretcher, minimum 2.50 m

**b)** The clearance heights on the escape routes shall not be less than 2,10 m.

**c)** The provisions will be taken into account **Article 3.2.4.3.**

**A.10. 3.10.52.** Depending on the number of levels of the existing building and the number of patients who can be transported by stretcher or trolley from the most crowded level, it is recommended that the lifts for them should be so constructed and powered that they can also be used to evacuate patients in the event of fire.

**A.10. 3.10.53.** *The maximum lengths of escape routes in existing health care buildings, which are not high or very high, shall be provided taking into account the need to transport patients by stretcher or trolley are specified in accordance with the provisions of Table 67: Escape lengths in above-ground healthcare buildings of normal height (where transport of patients by stretcher or trolley is required) and Table 68: Evacuation lengths in above-ground healthcare buildings of normal heights (not requiring transport of patients by stretcher or trolley).*

**A.10. 3.10.54.** *The fire performance of walls on escape routes shall comply with the conditions in Table 155 (if there are no existing tall or very tall buildings).*

**A.10. 3.10.55.** *Lifts also used for the evacuation of persons in the event of fire (referred to in Art. A.10.3.10.52.), shall be located in their own shafts, with walls made of materials of reaction to fire class A1, A2s1d0, fire resistant for a minimum of 2 hours (EI/REI120).*

**A.10. 3.10.56.** *The design and construction of ramps and staircases or inclined surfaces shall comply with the conditions of Art. A.10.2.4.32. and Art. A.10.2.4.33.*

**A.10. 3.10.57.** *For the evacuation of patients transportable by stretcher or trolley, the evacuation capacity (C) of a stream is considered to be a maximum of 50 persons.*

**A.10. 3.10.58.** *For evacuation routes for patients which can move on their own, the general conditions shall be complied with, but stairways with rocked steps shall be prohibited.*

**A.10. 3.10.59.** *In existing multi-storey healthcare buildings, it is recommended that rooms for patients who can be transported by stretcher or trolley are located on the first floors above ground.*

**A.10. 3.10.60.** *Existing health buildings with hospitalisation places will have access to at least two facades.*

#### **Existing buildings for culture**

**A.10. 3.10.61.** *Existing buildings for culture (exhibitions, museums, libraries, clubs, rooms, cultural centres and complexes, cinemas, theatres, multi-purpose rooms, etc.), in addition to the common measures set out in this Annex, shall also comply with the specific ones.*

**A.10. 3.10.62.** *Existing buildings for culture shall meet the conditions of correlation between the fire stability level, the built-up area and the number of storeys, as laid down in this Annex, and where they comprise existing crowded rooms and their specifics.*

**A.10. 3.10.63.** *The conditions and performance levels relate to existing buildings for culture that are not tall and very tall and do not fall into the crowded rooms category.*

**A.10. 3.10.64.** *It is recommended that the layout of existing cultural buildings should ensure fire stability levels I, II or III, depending on the importance and heritage values housed and the number of people.*

**A.10. 3.10.65.** *The escape routes of existing constructions shall comply with the requirements and performance levels corresponding to the fire stability level provided and destinations, as specified in this Annex. The maximum length of escape routes in existing buildings for culture is given in Table 72: Escape lengths in above-ground culture buildings with normal heights. For existing buildings that are not tall, very tall or with crowded rooms, the fire performance of the walls of escape routes shall comply with the conditions in Table 156.*

**A.10. 3.10.66.** *Existing buildings for culture which are high, very high or contain crowded rooms will meet their specific performance levels, corresponding to the specific provisions.*

**A.10. 3.10.67.** *Publicly accessible spaces in existing cultural buildings shall be separated from ancillary and technical rooms by walls and floors of reaction to fire class A1, A2s1d0, fire resistant according to the annex.*



**A.10. 3.10.68.** In existing theatres with more than 600 seats and a stage set, the stage and its ancillaries (pockets, storerooms, workshops, etc.) are separated from the crowded auditorium by fire walls and safety curtains. Compared to other spaces accessible to the public, the separation is made by walls of reaction to fire class A1, A2s1d0 resistant to fire minimum 3 hours (REI180) and floors 1 hour and 30 minutes (REI90). If the scenes are max. 50 m<sup>2</sup>, the artists' rooms may have doors communicating directly with the hall or stage.

**A.10. 3.10.69.** In the fire walls separating the crowded room sector from the stage, in addition to the portal gap, two circulation gaps (one on each side of the stage) are permitted on each level of the existing building, protected by buffer rooms with 45-minute fire resistant doors (EI45-C). In curtained-off halls, these gaps shall be located outside the portion of the wall facing the hall so as not to lead directly from the stage or its appurtenances into the crowded room or audience escape routes and the gaps shall be protected by 1 hour 30 minute fire rated doors (EI90-C).

**A.10. 3.10.70.** In rooms with safety curtains, in cases of strict necessity, the connection between the stage and the rooms for spotlights, boxes, stage management, etc., which communicate freely with the hall, is made through buffer rooms with walls and floors with a fire resistance of 2 hours (EI/REI120 walls and REI120 floors), with fire-resistant doors of min. 1 hour and 30 minutes (EI90-C), equipped with self-closing devices.

**A.10. 3.10.71.** The walls and floors separating the stage and stage pockets from its appurtenances must be of reaction to fire class A1, A2s1d0, with a fire resistance of at least 1 hour and 30 minutes (EI/REI90 walls and REI90 floors). The gaps between the stage house and its annexes (workshops, booths, offices, etc.) including the related circulation routes, shall be protected by doors or other protective elements with a fire resistance of at least 45 minutes (EI45-C), equipped with self-closing devices.

**A.10. 3.10.72.** The floors of artists' booths and combustible material stores located under the stage must be A1, A2s1d0 and fire resistant for at least 1 hour and 30 minutes for booths (REI90) and 3 hours (REI180) for stores.

**A.10. 3.10.73.** Walls separating combustible material stores and ancillary workshops with a high fire risk from the rest of the existing building shall be of reaction to fire class A1, A2s1d0, with a fire resistance of at least 4 hours (EI/REI240) and without gaps other than those strictly necessary for circulation. The gaps shall be protected with fire resistant doors for a minimum of 1 hour and 30 minutes (EI45-C), equipped with self-closing or automatic closing devices in case of fire.

**A.10. 3.10.74.** The roofing of the stage house and the structures of the stage walkways and grills shall be made of materials of reaction to fire class A1, A2s1d0. Gaps of access to passageways shall be protected by fire resistant doors for 1 hour and 30 minutes (EI90-C), equipped with self-closing devices. Grates may be made of materials reaction class to fire **A1, A2s1d0** or **A2s1÷s3,d0÷d1; Bs1÷s3,d0÷d1** or **Cs1÷s3,d0÷d1**.

**A.10. 3.10.75.** Floors separating the stage or stage pockets from other rooms above them must be fire reaction class A1, A2s1d0 with a fire resistance of min. 2 hours (REI120).

**A.10. 3.10.76.** The walls and floors of the projection cab with more than one film projection apparatus, its stores and attachments shall be reaction class to fire **A1, A2s1d0** with fire resistance of min. 2 hours for walls and 1 hour for floors (**EI/REI120** walls and **REI60** floors).

**A.10. 3.10.77.** The projection booth must not communicate directly with the room in which the audience is located except through projection and observation windows, sealed against smoke by glazing and protected by metal shutters which, when closed in the event of fire, automatically switch on the lighting in the room. If incandescent lamps or gas-discharge lamps with a wattage of less than 2,000 W are used in the projection of safety films, the booth may communicate through 15-minute (EI15-C) fire-resistant doors with the room in which the public is seated, and the visors must not be protected by metal shutters unless they exceed 0.16 m<sup>2</sup>.

**A.10. 3.10.78.** *Communication of the safety film projection booth and its annexes with public escape routes shall be via buffer rooms only. The doors of the projection booth, the projection room, the electrical equipment room and the doors of the buffer room communicating with the rest of the existing building must have a minimum fire resistance of 15 minutes (EI15-C). All these doors must be fitted with self-closing devices.*

**A.10. 3.10.79.** *Communication between the nitrocellulose film projection cab and its attachments, as well as with the escape ladders serving other rooms, shall only be provided through buffer rooms. The doors of the projection booth, its annexes and the buffer room must be fire-resistant for 45 minutes and equipped with self-closing devices (EI45-C).*

**A.10. 3.10.80.** *Above the scene it is not recommended to arrange rooms for other destinations, and no deposits of combustible material will be placed under the scene, as well as workshops with high fire risk.*

**A.10. 3.10.81.** *The fire service room, which is related to the stages of the halls with more than 600 seats, will have good visibility into the stage and easy and safe access in case of fire to the rooms where firefighting or intervention is required, as well as from outside.*

**A.10. 3.10.82.** *For fire intervention on the upper parts of the stage, at the level of the podium, and in the basement, access will be provided via closed stairwells or external stairs. Access doors shall be fire resistant for a minimum of 45 minutes and equipped with self-closing devices (EI45-C).*

**A.10. 3.10.83.** *The smoke-tight, fire-resistant safety curtain must be capable of being lowered by remote control and manually within 40 seconds.*

**A.10. 3.10.84.** *Stages with safety curtains, stage pockets with an area of more than 100 m<sup>2</sup> and orchestra pits with more than 50 people must have two exits.*

*Note: Exits from the rooms referred to in Art. A.10.3.10.84. must be distinct from those of the room; for stages without safety curtains and pits with less than 50 persons, one of the escape routes may pass through the crowded room.*

**A.10. 3.10.85.** *The escape routes from balconies and boxes in theatres with theatrical stages, from audience service rooms and from at least one of the open platforms with more than 100 persons in other categories of theatres must not be routed through a crowded room.*

**A.10. 3.10.86.** *At least one of the escape routes from stage pockets and storerooms must have a separate route from the stage.*

**A.10. 3.10.87.** *Staircases with a surface area of more than 150 m<sup>2</sup> and pockets with a height of more than 10 m shall be provided with smoke evacuation in the event of fire (smoke extraction) by means of devices with a total free area of at least 5% of the floor area, or a suitably designed and dimensioned mechanical system in accordance with the technical standard.*

**A.10. 3.10.88.** *Devices provided for smoke evacuation (smoke extraction) in the event of fire, at stages and their pockets, shall be operated automatically either under the effect of temperatures or when pressures of 34 daN/m<sup>2</sup> (35 Kgf/m<sup>2</sup>), with the possibility of manual operation from accessible locations. Up to 40% of the area of the required smoke extraction devices may be replaced by self-opening windows located at the top of the stage (above the grills).*

**A.10. 3.10.89.** *For fire intervention, fire engines will have access to at least one facade of the existing culture building.*

### **Existing educational buildings**

**A.10. 3.10.90.** *Existing educational buildings (pre-school, school and higher education) shall meet the performance levels permitted in the specific technical regulations and provisions of this Annex.*

**A.10. 3.10.91.** *The location of existing buildings shall, as a rule, be carried out independently, at a distance from neighbouring buildings to another destination. Major distances of at least 50 % compared to those in Table 145 are recommended. When they are allotted or merged with other destinations, they shall be appropriately partitioned.*

**A.10. 3.10.92.** *The siting of existing educational buildings in the vicinity of buildings or installations with a fire or explosion hazard is not permitted.*

**A.10. 3.10.93.** *Existing educational buildings shall be designed and constructed in accordance with general, common and specific fire safety provisions, according to the relevant technical regulations, ensuring compliance with the conditions and permitted performance levels, differentiated according to the age of the users and the functional curricula.*

**A.10. 3.10.94.** *Rooms with a medium fire risk (laboratories, warehouses, school workshops, etc.) shall, as far as possible, be separated from crowded spaces or separated by fire-resistant elements of reaction to fire class A1, A2s1d0, designed and constructed to match the heat load and fire risk.*

**A.10. 3.10.95.** *While ensuring specific functionality, measures will be taken to limit potential sources of fire outbreaks and reduce combustible materials and substances in spaces and areas accessible to users.*

**A.10. 3.10.96.** *The ancillary annex spaces (heating plants, technical stations, fuel storage, generators, etc.) attached to the existing educational buildings, as a rule, are arranged independently or, when merged or grouped with the existing educational building, are separated by walls and floors of fire reaction class A1, A2s1d0 fire resistant according to technical regulations, with accesses totally separate from those of child users.*

**A.10. 3.10.97.** *In the ancillary and annex spaces of the existing educational building, specific protection rules and measures shall be observed, depending on their use and fire risk.*

**A.10. 3.10.98.** *The use or storage of liquids or combustible gases in places other than those specifically provided for and in the quantities laid down, as well as the failure to comply with specific fire prevention and extinguishing measures, are strictly prohibited.*

**A.10. 3.10.99.** *As a general rule, existing educational buildings shall be constructed of materials and building elements of reaction to fire class A1, A2s1d0 and fire resistant, ensuring the conditions of correlation between the level of fire stability, the built-up area and the number of storeys set out in this Annex Art. A.10.3.2.4. and Art. A.10.3.2.5 The use of combustible materials and construction elements is permitted under the conditions of the specific technical rules and regulations.*

**A.10. 3.10.100.** *Limiting the spread of smoke in spaces, rooms, corridors and escape staircases shall be ensured in existing educational buildings by the provision of vertical and horizontal partitions (walls, floors), suitably designed and dimensioned, as well as by making provision for easy evacuation of smoke produced in the event of fire, in accordance with specific regulations.*

**A.10. 3.10.101.** *Materials and finishes that do not easily propagate fire will be used in existing educational buildings.*

**A.10. 3.10.102.** *The use of plastic materials and finishes in areas accessible to children is not permitted, and in general, the use of those which release smoke and toxic gases in the event of fire will be eliminated.*

**A.10. 3.10.103.** *As a general rule, existing educational buildings shall be provided with two separate and independent escape routes so arranged and designed as to be easily accessible to all users. Exceptions are the situations provided for in the specific regulations.*

*In existing buildings for pre-school age children the evacuation capacity of a stream (C) shall be a maximum of 50 persons and in other educational buildings a maximum of 75 persons.*

**A.10. 3.10.104.** Existing multi-storey educational buildings shall have enclosed escape stairwells as set out in this Annex, irrespective of the number of storeys above ground.

**A.10. 3.10.105.** The design and dimensioning of escape routes shall comply with the standard, but irrespective of the widths resulting from the calculation, doors on escape routes for persons shall be at least 90 cm wide and stairways and corridors at least 1.20 m wide. The fire behaviour of the walls of the escape routes shall comply with the conditions in Table 157.

**A.10. 3.10.106.** When dimensioning the exhaust ducts, it is recommended to increase the widths specified in the general part of the standard by 50%.

**A.10. 3.10.107.** Children's homes and kindergartens in existing multi-storey buildings shall be provided with an external escape staircase (of the storey), regardless of the number of internal staircases.

**A.10. 3.10.108.** For multi-purpose rooms in existing educational buildings it is recommended to provide at least a direct access from the outside (external door) at ground level or an external escape staircase.

**A.10. 3.10.109.** The maximum permissible lengths of escape routes in existing educational buildings where the evacuation of users must be directed (in pre-schools, schools, colleges, boarding schools), with the exception of high, very high and crowded buildings, are given in Table 77: Escape lengths in educational buildings above normal heights, **no. 1**.

**A.10. 3.10.110.** The maximum permissible escape path lengths in higher education buildings, with the exception of high, very high or congested buildings, are given in Table 77: Escape lengths in educational buildings above normal heights, **no. 2**.

**A.10. 3.10.111.** Existing educational buildings will be provided with fire truck access to at least two facades.

#### **Existing buildings for tourism**

**A.10. 3.10.112.** Existing buildings for tourism (hotels, motels, villas, bungalows, cottages, etc.) will meet the performance levels allowed in the standard and will also meet the specific ones.

**A.10. 3.10.113.** Depending on the use and type of the existing building, the correlation between the fire stability level, the number of levels and the fire compartment area shall be ensured, according to Art. A.10.3.2.4. and Art. A.10.3.2.5. For existing tourist buildings that are tall, very tall or with crowded rooms, their specific performance shall be respected.

**A.10. 3.10.114.** For existing tourist buildings with max. P+2 levels (3 levels) and a maximum of 50 persons per floor, escape staircases with balanced steps are allowed if they ensure the passage of a single escape flow (regardless of whether the width of the ramp is greater) and if they are made in accordance with Art. A.10.2.5.40.

**A.10. 3.10.115.** Monumental staircases may be open to the full height of the existing building if they ensure that the spread of fire and smoke in the building is limited and the necessary enclosed staircases for evacuation are provided.

**A.10. 3.10.116.** In cases where existing buildings also have underground levels (basements, crawl spaces), these will be separated from the above ground levels by fire reaction class A1, A2s1d0, fire resistant for a minimum of 2 hours (REI120).

**A.10. 3.10.117.** It is recommended to provide direct natural lighting of stairwells.

**A.10. 3.10.118.** In existing tourist buildings, the fire performance levels of the elements making up the escape routes shall comply with those laid down in Table 158, except for tall, very tall or crowded buildings, for which specific provisions shall be complied with.

**A.10. 3.10.119.** Ramps and floors of stairs or sloping planes shall comply with the conditions set out in Article **A.10.2.4.32.** and Article **A.10.2.4.33.**

**A.10. 3.10.120.** The capacity (C) of an evacuation flow (F) is a maximum of 70 persons.

**A.10. 3.10.121.** The maximum lengths of escape routes in tourist buildings are given in Table 80: Exhaust lengths in above-ground tourist buildings of normal heights (excluding existing tall, very tall or crowded room buildings).

**A.10. 3.10.122.** The walls of escape routes for persons (if not existing tall or very tall buildings) shall comply with the conditions in Table 158.

**A.10. 3.10.123.** Existing buildings for tourism will have access to at least two facades for fire response vehicles.

### **Existing worship buildings**

**A.10. 3.10.124.** Existing worship buildings (cathedrals, churches, chapels, houses of worship, synagogues, temples, etc.), as well as monastery complexes, shall meet the appropriate performance requirements set out in this Annex, supplemented by their specific requirements.

**A.10. 3.10.125.** The location of existing buildings of worship shall, as a rule, be carried out independently, at a distance from neighbouring existing buildings, in accordance with Art. A.10.2.2.2. and Table 145, or are subdivided from them.

**A.10. 3.10.126.** Within monastery complexes, buildings of worship may be merged or grouped with other existing monastery buildings within regulated fire compartments (provided for in this Annex).

**A.10. 3.10.127.** Existing ground-floor cult buildings with a maximum simultaneous capacity of 200 people may be made of materials and construction elements of reaction to fire class **A2s1÷s3,d2; Bs1÷s3,d2; Cs1÷s3,d2; Ds1÷s3,d2; ED2** and provided only with fire extinguishers in case of fire, and for those with higher simultaneous capacities, the specific provisions for crowded rooms shall be observed.

**A.10. 3.10.128.** Existing buildings of worship, regardless of maximum capacity at the same time, shall have at least two separate and independent escape routes for persons. Exceptions are those with a maximum simultaneous capacity of 30 people.

**A.10. 3.10.129.** Existing cult buildings of fire stability level III-V, can have a sub-slope (balcony) for a maximum of 30 people and whose evacuation can be done through an open staircase in the ground floor of the building.

**A.10. 3.10.130.** Existing worship buildings with a basement will have separate access to the basement and where the basement contains functional spaces necessary for worship, internal circulation between the basement and the ground floor may also be provided, provided that they are fitted with fire-resistant doors for a minimum of 30 minutes (EI30-C) and equipped with self-closing or automatic closing devices in the event of fire.

**A.10. 3.10.131.** The use of open fire (candles, candelas, etc.) in existing buildings of worship shall be permitted only if specific fire prevention measures are ensured and, where appropriate, only in places duly established and adapted.

**A.10. 3.10.132.** Existing houses of worship with a capacity of 30 people or more will have exterior opening exit doors.

**A.10. 3.10.133.** Existing places of worship provided with fixed seats (chairs, benches, pews) will have this furniture fixed to the floor or walls, or attached to packages of chairs (benches), according to Art. A.10.4.1.45.

**A.10. 3.10.134.** The maximum permissible escape lengths in existing buildings of worship are given in Table 81: Escape lengths in grooming buildings of normal heights (excluding crowded rooms).

**A.10. 3.10.135.** *The utilities related to existing buildings of worship (sanitary, electrical, heating, ventilation, etc.) are designed and built in accordance with the provisions of their specific technical regulations.*

**A.10. 3.10.136.** *Except for in the cases exempted by these specific provisions, the equipment and endowment of existing worship buildings with fire signalling and firefighting facilities and means shall be carried out in accordance with the specific technical regulations.*

**A.10. 3.10.137.** *Existing buildings of worship will be provided with access for fire fighting vehicles to at least one facade.*

### **Existing sports buildings**

**A.10. 3.10.138.** *Existing sports buildings shall be designed and constructed in accordance with the provisions of this Annex and the specific regulations, ensuring adequate fire safety. In existing sports constructions, the reaction to fire levels of the elements making up the escape routes shall comply with those set out in Table 82: Fire behaviour of walls, doors and partitions of enclosed stairwells in above-ground sports buildings of normal heights and Table 83: The fire performance of walls, doors and floors separating horizontal escape routes (corridors and hallways) in above-ground sports buildings of normal heights, except for tall, very tall or crowded buildings, for which specific provisions shall be complied with. The maximum length of escape routes in sports buildings is given in Table 84: Exhaust lengths in enclosed above-ground sports buildings of normal heights (excluding existing tall, very tall or crowded room buildings).*

**A.10. 3.10.139.** *Existing outdoor sports facilities and existing outdoor sports facilities (land, basins, etc.) will comply with their specialised regulations.*

**A.10. 3.10.140.** *For existing sports buildings falling within the busy room category, the provisions of this Annex relating to such rooms shall be complied with.*

**A.10. 3.10.141.** *Existing (closed) sports buildings shall be equipped and endowed with fire prevention and firefighting facilities and means, in accordance with specialised regulations.*

**A.10. 3.10.142.** *Existing sports buildings will have a minimum of one side of the building ready for the intervention of the emergency vehicles, and when there are crowded rooms, at least two sides.*

## **A.10. 3.11. PERFORMANCE OF EXISTING DEVELOPMENTS AND BUILDINGS**

### **Outdoor facilities**

**A.10. 3.11.1.** *When designing and implementing outdoor facilities, such as meetings, concerts, cinemas, performances, etc. (without walls and roof), compliance with the fire safety measures laid down for them (own) shall be ensured.*

**A.10. 3.11.2.** *Outdoor facilities shall be equipped with first response means, providing one portable fire extinguisher with minimum extinguishing performance 21A and 113B every 250 m<sup>2</sup> and one transportable fire extinguisher with extinguishing performance for type A and B outbreaks with a rated load of 50 kg per 1,000 m<sup>2</sup> maximum. The provisions of OMAI 14/2009 have been complied with.*

### **Existing campsites, holiday villages**

**A.10. 3.11.3.** *The design and execution of existing campsites (arrangements for the placement of tents, caravans, provisional boxes, etc.), with or without utility buildings, is carried out in accordance with their own fire safety requirements.*

**A.10. 3.11.4.** *For existing utility buildings and final annexes to campsites (for commerce, catering, clubs, discotheques, social groups, central centres and technical areas, etc.), the general and specific provisions set out in the Annex shall be complied with.*

**A.10. 3.11.5.** Existing campsites shall be located at appropriate distances from fire risk neighbourhoods, including international and national roads, typically more than 50 m.

**A.10. 3.11.6.** Existing campsites shall be located at minimum distances from **100 m** with respect to running railway lines.

**A.10. 3.11.7.** The internal organisation of the existing campsites will ensure the creation of camping platforms with a maximum area of 800 m<sup>2</sup>, delimited by roadways allowing fire-fighting intervention on at least one side.

**A.10. 3.11.8.** Camping platforms will be delineated and marked accordingly.

**A.10. 3.11.9.** Existing utility buildings and permanent annexes shall be sited at the safety distances laid down in Art. A.10.2.2.2. and Table 145, considering the camping platforms as existing buildings of fire stability level V.

**A.10. 3.11.10.** In order to limit the slight spread of fire, at least the safety distance between existing buildings of fire stability level V shall be ensured between the camping platforms (each of maximum 800 m<sup>2</sup>).

**A.10. 3.11.11.** Existing campsite enclosures with a total area of more than 3,000 m<sup>2</sup> shall be provided with means of alarm in case of fire and possibilities to alert the fire brigade.

**A.10. 3.11.12.** Existing campsites with an area of 5,000 m<sup>2</sup> and more are recommended to extinguish fires from the outside by means of external fire hydrants or water tanks and mobile pumps. The extinguishing rate shall be at least **4,2,1/s**, for a period of operation of **60** minutes and the profile extinguishing norm shall be followed.

**A.10. 3.11.13.** Existing utility buildings and final annex shall be fitted with signalling and fire-fighting installations in accordance with the specific regulations.

**A.10. 3.11.14.** Existing campsites shall be equipped with first-aid equipment and at least one outside fire station shall be provided at each camping site. Final existing constructions shall be equipped with extinguishing equipment in accordance with the relevant technical regulations.

**A.10. 3.11.15.** The fire service is built up and organises at campsites with the area of the 10,000 m<sup>2</sup> enclosure even more.

**A.10. 3.11.16.** The provision and implementation of the related utility installations shall be ensured in accordance with the specialised technical regulations.

### **Existing mountain buildings**

**A.10. 3.11.17.** In the design and construction of existing buildings located isolated, in mountainous areas, at height and outside the localities, (referred to as mountainous), such as huts, hotels, sanatoriums, etc., the design of the provisions of this Annex shall be ensured supplemented with those specific to them.

**A.10. 3.11.18.** The location shall be such as to ensure the limitation of the slight propagation of fires to neighbours (buildings, installations, wooded masses, etc.) by recommended safety distances of at least 5 times the height of the building, but not less than those specified in this Annex.

**A.10. 3.11.19.** Existing mountain buildings, by compliance, will have accommodation separated from other functions (restaurants, kitchens, etc.) by fire reaction class A1, A2s1d0 and fire resistant elements minimum 1 hour (EI/REI60 walls and REI60 floors). For sanatoriums, the provisions specific to health buildings are also respected.

**A.10. 3.11.20.** Existing mountain buildings may be of fire stability level V fire resistance and a maximum of three levels if an automatic signalling and immediate alarm system for users is provided and the maximum simultaneous capacity is a maximum of 100 persons.

**A.10. 3.11.21.** *It is recommended that by design and implementation, the built-up areas, referred to in Art. A.10.3.2.4., be reduced by 50% for fire stability levels IV and V of mountain constructions.*

**A.10. 3.11.22.** *The composition of the building elements will limit the possibilities for light fire transmission (vertical and horizontal).*

**A.10. 3.11.23.** *Escape routes for persons in the event of fire shall be safe, separated from the rest of the building by fire-resisting elements for a minimum of 30 minutes (EI/REI30), and staircases shall be enclosed in stairwells separated from the rest of the building by a wall of reaction to fire class A1, A2s1d0 with a fire resistance of at least 1 hour (EI/REI60), when providing escape from more than one level.*

**A.10. 3.11.24.** *It is recommended that the lengths of escape routes for persons in existing buildings of fire stability levels IV and V should be reduced by at least 25% compared to those specified in Art. A.10.3.10.121.*

**A.10. 3.11.25.** *The technical annexes (heating plant, generator, pumping station, etc., including storage of combustible materials or substances) should be built in an existing independent building. Where they are built into the existing building, they shall be separated with building elements of reaction to fire class A1, A2s1d0 and fire resistant for a minimum of 1 h 30 minutes (EI/REI90 walls and REI90 floors).*

**A.10. 3.11.26.** *Existing mountain buildings are equipped with first aid (portable, transportable fire extinguishers and fire pickets), appropriate to the specific conditions. Existing buildings with a maximum simultaneous capacity of more than 100 people and 3 or more storeys shall also be equipped with fire-fighting equipment in accordance with the relevant technical regulations.*

**A.10. 3.11.27.** *Existing mountain buildings shall have related utility installations designed and constructed in accordance with the provisions of their specialised regulations.*

**A.10. 3.11.28.** *Local heating with heat storage stoves is permitted in existing buildings of up to three storeys, provided that appropriate local protection measures are in place.*

**A.10. 3.11.29.** *In existing mountain buildings with higher capacities of 300 places, fire brigade services consisting of specially trained staff will be organised.*

### **Car parks**

**A.10. 3.11.30.** *In the design and construction of existing car parks, the fire safety measures laid down in these provisions, supplemented by the clarifications in section 3.2.11, shall be ensured. Parking spaces for cars in the Rules (for situations not specified in this Annex).*

**A.10. 3.11.31.** *Enclosed spaces for the parking of cars attached to existing civil (public) buildings or buildings intended for public use (public car parks) are considered as spaces or, where appropriate, existing civil (public) buildings with a high fire risk.*

**A.10. 3.11.32.** *The location of these enclosed public car parks may be incorporated into, attached to, or independent of existing public (civil) buildings at permitted distances, or subdivided as provided for in this Annex.*

**A.10. 3.11.33.** *Enclosed public parking lots shall be fire rated to ensure functionality while limiting the spread of fire into existing public civil buildings.*

**A.10. 3.11.34.** *It is recommended that existing enclosed public car parks for more than 5 cars should, where appropriate, be made of materials and construction elements corresponding to fire stability levels I, II and III.*

**A.10. 3.11.35.** *Existing enclosed public car parks for up to 5 cars can be of fire stability level IV or V.*



**A.10. 3.11.36.** Existing enclosed public car parks shall be separated from the existing civilian (public) building in which they are incorporated by floor slabs of reaction to fire class A1, A2s1d0 fire resistant for a minimum of 3 h (REI180) and walls of reaction to fire class A1, A2s1d0 fire resistant for a minimum of 4 h (EI/REI240), unless the regulations provide for more stringent measures.

**A.10. 3.11.37.** Enclosed parking areas attached to existing residential buildings and having a maximum capacity of 3 cars may be separated from them by partitions of reaction to fire class A1, A2s1d0 with a minimum fire resistance of 1 h (EI/REI60).

**A.10. 3.11.38.** Closed public parking lots will have the possibility to evacuate users in case of fire, with an escape length not exceeding 40 m in two directions and 25 m in one direction respectively (dead-end corridor) in existing constructions of the fire stability level I-II and respectively 30 m and 16 m for those of fire stability level III. In constructions of fire stability level IV and V, the exhaust length to an outside door will not exceed 12 m.

**A.10. 3.11.39.** The provision of evacuation conditions in existing public multi-storey car parks shall be carried out in accordance with the provisions of this Annex.

**A.10. 3.11.40.** Existing enclosed public car parks with a capacity of more than 5 parking spaces shall be provided with smoke evacuation devices in case of fire (smoke extraction), covering 1% of the area, suitably designed and sized according to the regulations or mechanical smoke evacuation systems.

**A.10. 3.11.41.** The equipment and provision of prevention and fire-fighting installations and means shall be provided in accordance with the regulations.

**A.10. 3.11.42.** The design and construction of utility installations for existing public car parks shall be carried out in accordance with the relevant regulations.

**A.10. 3.11.43.** Existing closed public car parks with more than 500 parking spaces will have fire brigade services.

## **CHAPTER 4**

### **SPECIFIC PERFORMANCE OF EXISTING CIVIL (PUBLIC) BUILDINGS**

#### **PERFORMANCE OF EXISTING TYPES OF CIVIL (PUBLIC) BUILDINGS**

##### **A.10. 4.1. PERFORMANCE OF EXISTING TYPES OF CIVIL (PUBLIC) BUILDINGS**

###### **Existing tall and very tall buildings**

**A.10. 4.1.1.** Existing tall and very tall buildings shall be of fire stability level I. Where they have portions less than 28 m in height, they are permitted to be of fire stability level II if in the event of fire they do not affect the stability of the existing building. Roofs or terraces of these types of existing buildings shall be made of materials of reaction to fire classes A1, A2s1d0.

**A.10. 4.1.2.** In existing tall and very tall buildings, fire compartments may consist of existing free-standing buildings, portions of which have floor areas permitted in Table 147, or enclosed volumes of which (volumetric portions comprising one to three successive built levels) with a maximum total floor area of 2,500 m<sup>2</sup>, bounded by vertical and horizontal partitioning elements (walls and floors). The walls and floors of the enclosed volumes referred to shall be fire reaction class A1, A2s1d0 with the fire resistance of the walls determined according to the heat load density according to Table 146 and of the floors a minimum of 2 hours (REI120).

**A.10. 4.1.3.** In existing tall and very tall buildings, the heat load density, resulting from the construction materials and elements used (excluding bonded floors), shall not exceed 275 MJ/m<sup>2</sup>.

The total heat load density resulting from building materials and elements, finishes, furniture and other housed materials should not exceed 840 MJ/m<sup>2</sup>.

**A.10. 4.1.4.** Rooms with a heat load density above 840 MJ/m<sup>2</sup> separated from the rest of the existing building by walls with fire resistance corresponding to the thermal load density but minimum 3 hours (EI/REI180) and floors with fire resistance 2 hours (REI120) in very tall existing buildings and 1 hour (EI/REI60 walls and REI60 floors) respectively in tall existing buildings. In existing high-rise buildings, the communication gaps with escape routes may be protected by fire-resistant doors, shutters or curtains for a minimum of 1 h 30 minutes (EI90-C), fitted with self-closing devices or automatic closing in the event of fire.

**A.10. 4.1.5.** For rooms in existing high-rise buildings where the heat load density exceeds 840 MJ/m<sup>2</sup>, they shall be separated by fire partition elements of reaction to fire class A1, A2s1d0, fire resistant to the heat load density and (these rooms) shall be provided with automatic fire signalling and extinguishing systems. In very tall existing buildings the communication gaps with the escape routes in these walls must be protected by buffer rooms and doors with a fire resistance of at least 45 minutes (EI45-C) provided with self-closing devices, or in technically justified cases by open drums.

**A.10. 4.1.6.** In order to limit the spread of fires, walls and floors shall be provided between existing stretches of buildings for different purposes and between escape routes and rooms adjacent thereto reaction class to fire **A1, A2s1d0** fire-resistant, depending on the destination and the density of the heat load. The load-bearing construction elements of the existing tall or very tall building, which pass through rooms with different uses, shall be constructed and protected in such a way that the stability of the existing building is not affected in the event of fire.

**A.10. 4.1.7.** In the walls between fire compartments, communication is via buffer rooms with firetight doors for a minimum of 1 hour (E60-C) in existing very tall buildings (exceeding 45 m) or firetight doors for 30 minutes (E30-C) in tall buildings (between 28 and 45 m). In both cases the doors of the buffer rooms shall be provided with self-closing or automatic closing systems in case of fire.

**A.10. 4.1.8.** In order to limit the spread of fire within fire compartments, partitions between portions of the existing building with different uses, as well as those between common escape routes and adjacent rooms, shall be of reaction to fire class A1, A2s1d0, as specified in Table 159 fire resistant for at least 2 hours (REI/EI180), and floors shall be of reaction to fire class A1, A2s1d0 fire resistant for at least 1 hour (REI60). In existing high and very high buildings, the use of partitions of the reaction to fire classes reaction class to fire **Cs1÷s3,d0÷d1** or **Ds1÷s3,d0÷d1** or **A2s1÷s3,d2; Bs1÷s3,d2; Cs1÷s3,d2; Ds1÷s3,d2; ED2**, is prohibited.

**A.10. 4.1.9.** On upper levels, access openings to escape staircases shall be protected with buffer rooms to prevent the spread of smoke in accordance with the provisions of this Annex, constructed with **A1, A2s1d0** fire resisting walls and floors for a minimum of 60 minutes (EI/REI60 walls and REI60 floors) and fitted with doors of reaction to fire class A1, A2s1d0 or reaction to fire class **A2s1÷s3,d0÷d1; Bs1÷s3,d0÷d1** or **Cs1÷s3,d0÷d1** firetight for at least 30 minutes (E30-C) in existing high-rise buildings and doors of reaction to fire class A1, A2s1d0 or **A2s1÷s3,d0÷d1** respectively; **Bs1÷s3,d0÷d1** fire tight for 60 minutes or more (E60-C) in very high existing buildings. Stairway ramps on underground levels are separated from those above ground through walls and floors reaction class to fire **A1, A2s1d0**, fire resistant. Communication between underground and aboveground ramps is permitted through a fire-resistant door for a minimum of 90 minutes (EI90-C). At underground levels access to stairwells is permitted only through buffer rooms fitted with fire resistant doors for a minimum of 60 minutes (EI60-C) and smoke evacuation provided. In all cases, buffer room doors shall be equipped with self-closing or automatic closing systems in case of fire.

**A.10. 4.1.10.** Exterior perimeter enclosures of existing tall and very tall buildings shall be so designed and constructed as to limit the transmission of fire from one level to another. External

perimeter enclosures shall be made of elements of reaction to fire class A1, A2s1d0 fire resistant for a minimum of 15 minutes (EI15-C). To limit the transmission of fire on facades, minimum 1.20 m separations, reaction to fire class A1, A2s1d0, firetight for a minimum of 30 minutes (E30) between glazing and only external joinery of reaction to fire class A1, A2s1d0, shall be used.

**A.10. 4.1.11.** Partitioning elements between car parking spaces and existing tall and very tall buildings to which they adjoin or into which they are incorporated shall be fire reaction class A1, A2s1d0 with a minimum fire resistance of 4 hours for walls and 3 hours for floors (EI/REI240 walls and REI180 floors). Functional communication gaps are permitted in these walls, but protected by buffer rooms whose doors must be fire-resistant for at least 1 hour (EI90-C) and fitted with self-closing or automatic closing devices in the event of fire or in technically justified cases with open drums, made in accordance with the provisions laid down in this Annex.

**A.10. 4.1.12.** The vertical installation halls are separated from the rest of the existing construction by walls of reaction to fire class A1, A2s1d0 with a minimum fire resistance of 60 minutes (EI60). Hatches and manholes in vertical shaft walls shall be made of **A1, A2s1d0** materials with a minimum fire resistance of 30 minutes (EI30) and shall not open into the stairwell. Vertical shafts shall, as a general rule, be separated when passing through floor slabs bounding fire compartments, with elements of reaction to fire class A1, A2s1d0, which shall provide the same fire resistance as the pierced floor slab, and where separation is not possible or technically justified, the shaft walls shall be of minimum 3 hours fire resistance (EI/REI180) and their access doors (hatches) of 1 hour and 30 minutes (EI90-C). The horizontal ducts are closed with non-combustible diaphragms when passing through the walls delimiting the fire compartments, ensuring a fire resistance equal to that of the pierced element.

**A.10. 4.1.13.** Horizontal common passageways and stairwells which do not have direct openings to the outside through which smoke can be evacuated in the event of fire shall be equipped with devices or systems for the evacuation of smoke (smoke extraction), constructed in accordance with the provisions of this Annex. Smoke exhaust (smoke extraction) of underground spaces and rooms (basement) is provided independently of that of the above ground levels.

**A.10. 4.1.14.** The materials and finishes used in existing tall and very tall buildings must not allow fires to spread rapidly.

**A.10. 4.1.15.** The finish on escape routes shall be reaction to fire class A1, A2s1d0 with the exception of carpet floors of max. 20 mm thickness and foil finishes of max. 5 mm thick, which may be of reaction to fire class A1, A2s1d0 or A2s1÷s3,d0÷d1; **Bs1÷s3,d0÷d1** or **Cs1÷s3,d0÷d1**.

**A.10. 4.1.16.** Suspended ceilings shall be of reaction to fire class A1, A2s1d0, with supporting elements of reaction to fire class A1, A2s1d0 resistant to fire min 30 minutes (EI30 a ↔ b). The space between the suspended roof and the strength floor shall be interrupted by diaphragms of the same fire resistance, located to the maximum extent **25 m** in two perpendicular directions.

**A.10. 4.1.17.** Lifts in existing tall and very tall buildings will have their own lift shafts, separated from the rest of the existing construction by walls of reaction to fire class A1, A2s1d0 fire resistant for a minimum of 2 hours (EI/REI120), in which only access shafts from existing building levels are permitted. A maximum of three lift cars can be arranged in a single shaft.

**A.10. 4.1.18.** In existing high-rise buildings, lift access shafts in the upper (landing) levels shall be protected by fire doors with a minimum 2 hour fire resistance (EI120), with automatic closing, or by making lift access landings separate from the common horizontal circulation with fire doors, in which case, by adding the fire resistances of these doors to those of the lift (landing) doors, a minimum 2 hour fire resistance is ensured. Under the same conditions, in existing high-rise buildings the access openings to lifts (landing) shall be protected with fire resistant doors for a minimum of 1 hour (EI60).

**A.10. 4.1.19.** Where lifts open into the basements of existing buildings, the communication shafts with the underground levels must be protected by buffer rooms fitted with fire-resistant doors for a minimum of 1 hour and 30 minutes (EI90-C) and equipped with self-closing devices. Exceptions are low fire risk basements, which are separated in the same way as above ground levels.

**A.10. 4.1.20.** Automatic closing of lift shaft protection doors (on all levels of the existing building) must be provided centrally when the alarm is given and locally when the temperature reaches 90 °C at the top, with manual override.

**A.10. 4.1.21.** In the event of a breakdown or stoppage, the lifts will be so designed as to allow the cars to be brought to a nearby access landing and in the event of a fire all cars will be automatically brought to the ground floor. These provisions are also mandatory for other vertical transport or circulation systems provided in existing high and very high buildings (lifts, lifts, etc.).

**A.10. 4.1.22.** In existing high-rise buildings, at least one of the lifts, easily accessible, shall be designed to meet the requirements of fire emergency operations in very tall buildings, at least two such lifts must be provided.

**A.10. 4.1.23.** Firefighting lifts shall be capable of transporting 3-5 service personnel with the respective equipment (minimum 500 kg) and shall be so constructed and separated from the rest of the existing construction as to operate for at least 2 hours after the outbreak of fire. These lifts will provide firefighters with access to all levels of the building and will be equipped with priority call devices in case of fire.

**A.10. 4.1.24.** In existing high and very high buildings it is mandatory to ensure at least two distinct and independent escape routes. The evacuation capacity (C) of an evacuation flow taken into account in tall and very tall buildings is 70 persons, unless lower capacities are laid down in the standard or in this Annex for some nominated destinations. The maximum permissible length of the route taken on escape routes from the door of the room to the nearest door of the access buffer to the escape stairway enclosure or protected landing (measured in accordance with Art. A.10.2.5.69.), depending on the use of the existing building, shall comply with Table 160.

**A.10. 4.1.25.** In existing tall and very tall buildings at all levels, each of the escape staircases must be easily accessible via independent routes, usually with different directions of travel, and at least one of the escape staircases must have access to the terrace above the top level. The use of escalators shall comply with the provisions of Article. **A.10.4.1.54.**

**A.10. 4.1.26.** Existing tall and very tall buildings shall be equipped and endowed with means, installations and systems for preventing and extinguishing fires, in accordance with the provisions of the specific technical regulations. Exceptions are residential buildings. In existing tall and very tall buildings, external access routes for emergency vehicles shall be provided on at least two sides.

**A.10. 4.1.27.** Existing very tall buildings will have fire services set up, properly equipped and staffed, located as close as possible to a ground level access.

#### **Existing buildings with crowded rooms**

**A.10. 4.1.28.** In crowded rooms, the fire safety measures shall be determined according to the capacity, destination and category of the room and the level of fire stability of the existing building.

**A.10. 4.1.29.** For multi-function rooms, protective measures shall be provided according to the worst category of the room, in accordance with the provisions laid down in this Annex.

**A.10. 4.1.30.** After destination, busy rooms may be of category S1 or S2 as specified in Table 161.

**A.10. 4.1.31.** The correlation between the category of rooms, the number of inhabitants, the number of levels and the level of fire stability of existing buildings with crowded rooms shall be ensured as set out in Table 162 and Table 163.

**A.10. 4.1.32.** *Layout or construction of crowded rooms in existing buildings independent of the ground floor, of fire stability level IV- V shall be permitted only for:*

- *mobile circuses, shops and shopping centres, meetings, where spectators are quickly evacuated directly outside;*
- *clubs and discotheques and cinemas operating seasonally with a maximum of 300 seats,*
- *provisional exhibitions of local importance that do not house value exhibits, as declared by the owner (investor).*

**A.10. 4.1.33.** *Existing building portions of crowded rooms embedded in existing buildings for other purposes must be separated from the rest of the existing construction by building elements reaction class to fire **A1, A2s1d0** with fire resistance of min. 3 hours for walls (**EI/REI180**) and 11/2 hours for floors (**REI120**). Exceptions are the situations specified in this Annex. In a similar way, the existing building portions of several crowded rooms, regardless of the destination, shall be separated from each other.*

**NOTE:**

**1.** *At clubs, discotheques and cultural homes, the portions of the various club activities can communicate freely with the reception sector of the performance room as well as with other crowded rooms (meetings, conferences, etc.).*

**2.** *Locker rooms, offices, auditoriums, and meeting rooms in existing administrative, educational, and other civilian buildings with similar activities may have escape routes common to the existing building in which they are located.*

**3.** *Concert halls, meeting rooms, auditoriums, reading rooms, dance halls, discotheques, sports halls, food halls, waiting rooms, museums and exhibitions with non-combustible exhibits in existing public buildings may have gaps in the walls separating them, protected by firetight doors for a minimum of 15 minutes (**E15-C**).*

**4.** *Crowded rooms, pooled in an existing building, may have gaps for circulation between common parts of the associated existing building, protected by fire tight doors for 15 minutes (**E15-C**).*

**A.10. 4.1.34.** *Within the fire compartments or functional compartments of existing crowded rooms, rooms with a high fire risk or housing equipment or objects of particular importance shall be separated from the rest of the existing building by walls and floors whose fire resistance shall be determined according to the heat load density, the importance of the goods and the level of fire risk. Functionally required technical cabins may have fire resistant glazing to the hall or be protected by fire resistant shutters or draught curtains if these cabins are separated from the rest of the existing building under the same conditions as the crowded room. In addition to the above requirements, the separating elements must meet the conditions of Table 164.*

**A.10. 4.1.35.** *Walls and floors separating enclosed spaces for car parking from existing buildings with crowded rooms shall be of reaction to fire class **A1, A2s1d0**, fire resistant min. 4 hours for walls and 2 hours for floors. In these walls, only access openings necessary for circulation are permitted, protected by fire-resistant doors for 1 hour and 30 minutes (**EI90-C**), or buffer rooms with fire-resistant doors for 45 minutes (**EI45-C**), equipped with self-closing or automatic closing devices in case of fire.*

**A.10. 4.1.36.** *For the evacuation of smoke in the event of fire (smoke extraction), at the top of existing crowded rooms to which the public has access, provision shall be made for judiciously placed devices, the total surface area of which shall be at least 1/100 of the surface area of the room, or mechanical smoke extraction shall be provided.*

**A.10. 4.1.37.** Smoke extraction devices in case of fire to be provided at the top of rooms accessible to the public shall be distributed as evenly as possible. They may communicate with the outside, either directly or through chimneys of equivalent cross-section, having walls of materials of reaction to fire class A1, A2s1d0 with a fire resistance of at least 30 minutes (EI30). The smoke evacuation devices shall also be operable by hand controls, the doors of the room.

**A.10. 4.1.38.** Interior decorative elements, finishes, thermal and acoustic treatments of existing clustered rooms shall be so designed and constructed as not to propagate fire easily, as specified in this Annex.

**A.10. 4.1.39.** The interior decorative elements, finishes and thermal and acoustic treatments of existing crowded rooms will typically be reaction class to fire **A1, A2s1d0**. These can be reaction class to fire **A2s1÷s3,d0÷d1; Bs1÷s3,d0÷d1** or **Cs1÷s3,d0÷d1** or made of wood and flame retardant at least on the non-apparent part, including mounting skeleton. It is recommended that the distances between acoustic finishes or treatments and the supporting walls should not exceed 15 cm. The gaps thus produced shall be divided by diaphragms (which may be of flame retardant wood) into cells with maximum dimensions of **3.00 x 3.00 m**, so as to avoid the formation of currents conducive to the development of fires.

**A.10. 4.1.40.** In existing crowded rooms and their annexes where the public has access, the suspended ceilings will be reaction class to fire **A1, A2s1d0**. Suspended areas of ceilings implemented from reaction class to fire **A2s1÷s3,d0÷d1; Bs1÷s3,d0÷d1** or **Cs1÷s3,d0÷d1** or of flame retardant wood, if appropriate measures are provided to prevent the transmission of fires from one portion to another (through distances, non-combustible strips, etc.). In all cases suspended ceilings shall have supporting elements of reaction to fire class A1, A2s1d0 fire resistant for a minimum of 30 minutes (or full ceiling EI30 **a ↔ b**) and the space between the suspended ceiling and the load-bearing floor shall be interrupted by a maximum of 25 m (in two perpendicular directions) with diaphragms of reaction to fire class A1, A2s1d0.

**A.10. 4.1.41.** It is mandatory to provide at least two distinct and judiciously distributed evacuation exits for:

**a)** each level of existing crowded rooms, as well as for the levels of existing Lobbies and balconies with more than **100** persons;

**b)** foyers, buffets, cloakrooms and other public service rooms (existing) with an area of over **100 m<sup>2</sup>**.

**A.10. 4.1.42.** In existing halls with stages or podiums, the evacuation circulation will be organised in such a way that, as a rule, the audience does not move in the direction of the stage. No evacuation of the audience from the hall via the stage or podium is permitted. The dimensions of the exit aisles inside the halls will comply with Art. A.10.2.5.60.

**A.10. 4.1.43.** The evacuation capacities "C" of an evacuation flow taken into account in existing crowded rooms are set out in Table 165.

**A.10. 4.1.44.** The maximum permissible lengths on the route travelled on the escape routes are set out in Table 166.

**A.10. 4.1.45.** In order to ensure the quick and accident-free evacuation of the public, in existing crowded rooms, chairs, benches and furniture in general are fixed to the floor, so that they are not overturned in case of panic. Exceptions are lounges, where a maximum of 12 mobile chairs are allowed, and exhibitions and dance halls, where it is recommended that they be fixed on decks (without floor fixing). In existing meeting rooms with a maximum capacity of 200 seats, chairs and benches may be unsecured to the floor, provided they are connected in bundles of at least three rows. In existing multi-purpose halls it is recommended that chairs are rigidly connected to each other in rows and rows. Each row or row should be fixed solidly at both ends to the floor or walls, or fixedly attached to the other rows so that they become a bundle. In all cases, the fixing bars

*perpendicular to the rows and applied flush with the floor shall be no more than 20 mm thick and rounded in profile.*

**A.10. 4.1.46.** *The furniture shall be placed in existing crowded rooms in such a way that walking lanes are achieved with appropriate widths to ensure that the public has access to the exits from the room.*

**A.10. 4.1.47.** *At existing halls with seating or benches, folding seats may be provided in the aisles between the seating packs if:*

*automatically raised and held in that position when not in use, leaving the aisle width resulting from the calculation free;*

*when lowered, an aisle width of at least 80 cm remains free;*

*do not reduce (in the raised or lowered position) the width of the calculated escape passage between the seat pans.*

**A.10. 4.1.48.** *On the exit aisles of existing crowded rooms, no steps are allowed along the clear passageways between rows of seats.*

**A.10. 4.1.49.** *In existing auditoriums, concert halls, concert halls, multi-purpose halls and the like, the maximum number of seats in a row shall be determined according to the fire stability level of the existing building and the manner of evacuation of persons from the row, as shown in Table 167. The number of seats in a row shall not be limited in existing buildings of fire integrity levels I or II if doors are provided in the side walls of the hall so that at each end of a group of four rows of seats there is a door at least 1,10 m wide.*

**A.10. 4.1.50.** *The clearance between rows of seats must be at least 45 cm.*

**A.10. 4.1.51.** *When furniture is placed in rooms with seating, escape routes must be provided in case of fire, taking into account the following recommendations:*

*- tables seating a maximum of 8 should be placed with at least part of the table next to an aisle;*

*- rectangular tables, placed with the long side perpendicular to the escape aisles, shall have not more than 8 seats on each side,*

*- if they have access to only one aisle or 16 seats if they have access to two aisles. Seats are not provided at the ends of these tables in the exit aisles.*

*- if the number of seats on a side is more than three (between one aisle and the wall) or six (between two aisles), access passages to the aisles shall be provided with a clear width of at least **45 cm**;*

*- the clear width of the escape lanes shall ensure the passage of the number of flows determined by calculation;*

*- the dimensions of the seats, set back **15 cm** from the edge of the table, are also taken into account when determining clear passage widths.*

**A.10. 4.1.52.** *The use of drapes, curtains, drop curtains, etc. which may interrupt the escape routes of existing crowded rooms, even when non-combustible, is prohibited. No false doors or mirrored cladding are allowed on the escape routes of crowded rooms.*

**A.10. 4.1.53.** *The furniture delimiting common internal escape routes shall ensure appropriate conditions for the evacuation of users.*

**A.10. 4.1.54.** *In buildings with existing passenger agglomerations or with existing crowded rooms, escalators shall be permitted, provided that separate and independent escape routes are provided by normal stairways in accordance with this Annex. To prevent smoke penetration from one level to another, measures will be taken under the ceilings to screen the escalator gap and protect it with*

water curtains with automatic and/or manual activation in case of fire. At each level the nearest escape route will be indicated. Regardless of ramp width, the roller ladder may be considered as ensuring the passage of a single evacuation stream if:

- it can be stopped, from each level, by an easily accessible hand control;
- it is made of materials of reaction to fire class **A1, A2s1d0**, except for the finish of the steps and the handrails and drive wheels;
- the width of the steps shall be at least **25 cm**.

**A.10. 4.1.55.** Doors on the evacuation route from existing crowded rooms must open in the direction of evacuation at the simple press of the closing systems (safety bar) and have no protrusions that could hinder the passage of persons. On exterior doors or doors separating other functions in existing buildings, latching systems without locking, easy to operate when people are crowded in front of them, are allowed.

**A.10. 4.1.56.** In existing crowded rooms, the distance between the door side and the first step of a ramp descending must be at least **1.60 m** in front of the doors and of **1.00 m** laterally.

**A.10. 4.1.57.** The width of escape staircases where the public on different levels can observe the fire at the same time and simultaneously move towards the staircases shall be determined by the number of streams coming from the most populated level plus, for each of the other levels, the width required to evacuate 25% of the people on that level.

**A.10. 4.1.58.** The access doors to the closed escape stairwells will be full. These doors may be glazed (except for theatres) if automatic fire extinguishing systems are provided in the building, including on the attics of the stairwells concerned.

**A.10. 4.1.59.** In existing buildings with crowded rooms, horizontal common circulation and enclosed stairwells which do not have openings through which smoke can escape directly to the outside in the event of fire shall be provided with smoke exhaust (smoke extraction), carried out in accordance with the provisions of this Annex.

**A.10. 4.1.60.** The width of the ground-level escape exits (doors) must ensure the passage of the total number of streams coming up the stairs and all persons on the ground floor.

**A.10. 4.1.61.** The projection of films and slides must be done in specially equipped booths when more than one non-flammable film projection machine is used, and regardless of the number of machines when projecting nitrocellulose-based films.

**A.10. 4.1.62.** The projection booth for safety film and its appendages must have access to an escape route, which may be shared with those of the public, without passing through the hall. In the case of projection booths for nitrocellulose film, a second escape route independent of those of the public shall also be provided. Access from the projection booths and their annexes to the public escape routes shall be permitted only through buffer rooms. The second escape route from the projection booths may be a spiral staircase or a staircase with balanced steps, or a vertical metal staircase at least 80 cm wide.

**A.10. 4.1.63.** In front of exits from existing buildings or existing crowded rooms a clear space must be provided for people evacuating.

**A.10. 4.1.64.** Existing buildings with crowded rooms will be easily accessible from public roads, ensuring adequate conditions for fire fighting and rescue operations. External platforms for parking motor vehicles located in the vicinity of buildings with crowded rooms shall be located outside the clearance gauge necessary for the evacuation of the public from the buildings and access routes to the self-specialties of the fire brigade of the existing building and to water supplies.



**A.10. 4.1.65.** Stairways for the evacuation of persons from existing crowded rooms may have direct ramps to the basement where they provide access to public spaces and are adequately separated from other functions in the basement.

**A.10. 4.1.66.** Exterior stairways used for evacuation of crowded rooms should have a maximum slope of 1:2 and ramps and bridges should be at least 1.60 m wide and covered. Covered sloping surfaces are permitted as escape exits if they meet their specific conditions.

**A.10. 4.1.67.** Inner courtyards and spaces between existing buildings with crowded rooms may be considered for the evacuation of persons in case of fire, if they have sufficient width for the passage of the number of flows resulting from the calculation, but not less than 10.00 m.

#### **Existing underground buildings**

**A.10. 4.1.68.** Existing civil (public) underground buildings may be located functionally independent of other existing civil buildings or attached to or merged with existing above ground (public) buildings.

**A.10. 4.1.69.** Alterations to underground car parks in existing free-standing underground civil (public) buildings shall be designed and carried out in accordance with the provisions laid down in the relevant standard, and those combined in existing above ground civil buildings (their basements) in accordance with the provisions of this standard.

**A.10. 4.1.70.** In basements of existing above ground civil (public) buildings, the layout of functions and the provision of appropriate protective measures as set out in this Annex shall ensure that the spread of smoke and fire to the above ground levels of the existing building is limited.

**A.10. 4.1.71.** In the basements of existing civil (public) buildings above ground, it is not allowed to have spaces or rooms with danger of explosion, explosive substances or products, or liquefied gases. In addition, combustible liquids with a flammability temperature below 55 °C shall not be permitted at locations other than those specially arranged and marked, in the quantities and conditions laid down.

**A.10. 4.1.72.** The underground portions (basements) of existing above-ground civil (public) buildings shall comply with the fire stability classification of the existing above-ground building as specified in this Annex, and those rooms shall have specific fire hazards established and specified.

**A.10. 4.1.73.** Rooms and technical spaces in the basements of existing civil (public) buildings shall be designed and constructed in accordance with the provisions of this Annex and the specific technical regulations, ensuring the agapance of fire outbreaks therein and the propagation of smoke and fire to the existing building above ground and to the surroundings.

**A.10. 4.1.74.** Building materials and components used in sub-soils shall meet the conditions for reaction to fire and resistance to fire laid down in this Annex in such a way that they do not constitute pathways for the easy spread of smoke and fire.

**A.10. 4.1.75.** Basement rooms with a high fire risk shall be separated from the rest of the existing building by walls and floors of reaction to fire class A1, A2s1d0, with the fire resistance established in accordance with the provisions of this Annex, and the functional circulation gaps therein adequately protected.

**A.10. 4.1.76.** Stairwells and shafts for lifts or other vertical transportation systems - including their associated machine rooms in the basement - shall be separated from the rest of the existing building by fire-resisting elements of reaction to fire class A1, A2s1d0 as specified in this Annex, and access openings protected in accordance with the specific requirements of the existing above-ground building.

**A.10. 4.1.77.** Finishing, thermal and acoustic processes shall comply with the specific provisions set out in this Annex and in the specific technical regulations.

**A.10. 4.1.78.** *The routes provided for functional circulation in the subsoil of existing above-ground civil (public) buildings shall be constructed and dimensioned in such a way as to meet the conditions necessary to ensure evacuation in the event of fire, in accordance with the provisions of this Annex.*

**A.10. 4.1.79.** *Basements of existing above-ground civil (public) buildings shall be provided with escape routes in accordance with the provisions of this Annex applicable to the existing above-ground building, so that in the event of fire users can reach the outside at ground level as quickly and safely as possible.*

**A.10. 4.1.80.** *The routes of escape routes from underground public spaces (subsoil) must be such as to ensure that the direction towards the outside is easily recognisable by a judicious distribution and dimensioning of users.*

**A.10. 4.1.81.** *Escape stairways for users of underground spaces (basements) except where permitted by the Annex shall be enclosed in stairwells and shall have separate underground ramps and aboveground stairway ramps. Only functional connections between underground and above-ground ramps may be provided by means of traffic bays constructed and protected in accordance with the provisions of this Annex.*

**A.10. 4.1.82.** *The capacities of the exhaust streams and the maximum length of escape routes to be ensured shall be as specified in the Annex according to the level of fire stability of the above-ground building, its type and destination.*

**A.10. 4.1.83.** *Smoke exhaust (smoke extraction) from underground rooms and spaces shall be provided in the cases and under the conditions specified in the Annex, on basement levels, independently of the smoke exhaust (smoke extraction) of the above-ground levels of the building.*

**A.10. 4.1.84.** *The equipment and equipping of the basement spaces of existing underground buildings with fire-signalling and fire-fighting means and installations shall be carried out in accordance with the provisions of this Annex and the relevant technical regulations having regard to the whole of the underground building.*

**A.10. 4.1.85.** *The flow rates of the extinguishing systems with which they are equipped will be equally determined by the above ground fire compartment of the respective existing building.*

**A.10. 4.1.86.** *The utility installations related to the spaces and rooms in the basements of existing civil (public) buildings above ground shall be designed and executed in such a way as to avert the occurrence and propagation of fires, in accordance with the provisions of the relevant technical regulations (sanitary, electrical, thermal, ventilation-conditioning, etc.).*

**A.10. 4.1.87.** *In order to ensure appropriate conditions for intervention and rescue in the event of fire, provision shall be made for suitably designed, protected and marked external accesses and internal circulation.*

## SECTION III

### PRODUCTION AND/OR STORAGE CONSTRUCTIONS

#### CHAPTER 5

#### PERFORMANCE COMMON TO PRODUCTION AND/OR STORAGE CONSTRUCTION

##### A.10. 5.1. FIRE RISK (FIRE HAZARD CATEGORIES) AND FIRE STABILITY LEVEL

###### *Fire hazard categories*

**A.10. 5.1.1.** Existing zones, rooms, fire compartments and existing independent production and/or storage buildings shall have fire hazard categories determined, in accordance with Article **A.10.2.1.4.** canvas Article **A.10.2.1.7.** of this annex. Where combustible liquids are used or stored in such existing constructions, their specific measures as set out in this Annex shall also be complied with. Existing rooms, compartments and buildings for the parking of motor vehicles, which are not public, fall into fire hazard categories.

**A.10. 5.1.2.** The common and specific fire safety measures and performance levels set out in the Annex shall be provided according to the fire hazard categories determined and specified as mandatory in the documentation.

**A.10. 5.1.3.** In production installations located in the open air, the category of fire hazard shall be determined by the technician, independently for each installation having different characteristics in this respect, establishing and, where appropriate, ensuring the fire safety measures and the required performance levels specifying the areas up to which the protection measures laid down are to be applied.

**A.10. 5.1.4.** The delimitation of the areas up to which the fire safety measures required by fire hazard categories A and B (BE3) shall be extended shall take into account the possibility of the presence - during normal operation and in the event of damage - of mixtures of air with gases, vapours or dust in potentially explosive concentrations.

###### *Fire stability level*

**A.10. 5.1.5.** Existing constructions and, where appropriate, existing fire compartments intended for production and/or storage shall have the fire stability level determined and specified in the documentation.

The minimum conditions that the existing building must meet in order to be classified in a certain level of fire stability are those specified in **Art. A.10.2.1.8. to Art. A.10.2.1.14.**

**A.10. 5.1.6.** Unprotected or partially fire-protected metallic structures in areas directly exposed to thermal radiation may be used in production and/or storage structures at fire stability level II, regardless of the density of the heat load, in the following situations:

- buildings (fire compartments), production and/or storage buildings classified as fire hazard category D (EIB a) or E (BE1 b);
- production and/or storage buildings classified in fire hazard category C (BE2) with a maximum floor area of 2,000 m<sup>2</sup> and not more than 3 storeys above ground, if the limitation of the slight propagation of fire from one storey to another is ensured;
- existing ground floor buildings with more than 6.00 m stack height protected by automatic water sprinkler systems;
- existing buildings for the parking of motor vehicles covered but open at the perimeter as specified in this Annex.

**NOTE:**

When reducing the fire resistance of metal structures, consideration shall be given to the weight of each element to ensure the stability of the existing construction, its size category, the number of users, the value of the goods housed and the possible consequences of the collapse of the existing construction.

## **A.10. 5.2. LOCATION AND FIRE COMPLIANCE**

### **Location**

**A.10. 5.2.1.** Existing independent, pooled or grouped production and/or storage in accordance with the general recommendations shall be placed at the safety distances set out in Article. **A.10.2.2.1** to Article. **A.10.2.2.3.** or be suitably subdivided.

**A.10. 5.2.2.** Existing production and/or storage buildings classified in fire hazard category A or B (BE3ab) shall, as a general rule, be located independently, at standard distances (as specified in this Annex) or subdivided from other existing buildings or existing installations, and portions of existing buildings which are attached or incorporated shall be separated from the rest of the existing building by appropriate subdivision elements, having regard also to the provisions of Art. A.10.2.1.6. and Art. A.10.2.1.7.

**A.10. 5.2.3.** In existing independent buildings, parts, spaces or rooms with an explosion hazard – categories A and B (BE3 ab) – must be specified and demarcated for protection areas within which specific measures must be provided.

### **Fire compliance**

**A.10. 5.2.4.** Fire compliance of existing buildings and existing fire compartments intended for production and/or storage shall take into account the provisions of Art. A.10.2.2.5. to Art. A.10.2.2.10., and their specific requirements, ensuring that the conditions of correlation between hazard category, fire stability level, number of levels and floor area are met.

**A.10. 5.2.5.** The built-up areas of existing buildings and fire compartments and the number of permitted levels for production and/or storage construction shall be as specified in Table 168.

**A.10. 5.2.6.** It is not recommended to have existing rooms and spaces classified as category A or B (BE3a, b) fire hazard in the subsoil of existing above-ground buildings, and when technically justified only under explosion resistant floor separation.

**A.10. 5.2.7.** No materials or substances (combustible or non-combustible) shall be freely stored in the production premises, except in the quantities and sorts strictly necessary for the technological flow for the shift.

**A.10. 5.2.8.** The compliance of existing production and/or storage premises will be aimed at limiting the possibilities of fire and smoke propagation, ensuring that the dangerous ones are placed in separate areas and that the necessary protective measures are taken.

## **A.10. 5.3. CONSTRUCTIVE ASSEMBLIES**

**A.10. 5.3.1.** Existing production and/or storage buildings shall be constructed in accordance with the provisions of subchapter 2.4. of the Annex, meeting the permitted performance.

**A.10. 5.3.2.** By their construction and design, the construction elements used must not spread fire easily.

**A.10. 5.3.3.** The interior construction gaps of the building elements will have the continuity interrupted so as not to favour the propagation of smoke and fire in the existing construction.

**A.10. 5.3.4.** Rooms and enclosed spaces classified in fire hazard category D (BE1a) shall have walls and floors of reaction to fire class A1, A2s1d0.

**A.10. 5.3.5.** Ground ceilings (non-combustible or combustible) shall not be permitted in enclosed rooms and spaces classified in categories A or B (BE3a, b) of fire hazard.

**A.10. 5.3.6.** Building elements which enclose spaces of fire hazard categories A and B (BE3a,b) shall be of reaction to fire class A1, A2s1d0, and when separating them from the rest of the existing and explosion-proof construction.

**A.10. 5.3.7.** The beams, ramps, bridges and steps of internal staircases for functional circulation at work platforms - without permanent workplaces - may be made of materials of reaction to fire class A1, A2s1d0 and not enclosed in their own stairwells.

**A.10. 5.3.8.** Storage rooms with a floor area of more than 36 m<sup>2</sup> shall be designed and constructed in accordance with Art. A.10.2.4.45. and Art. A.10.2.4.46. and their specific provisions.

**A.10. 5.3.9.** Existing spaces, rooms and buildings classified as fire hazard category A or B (BE3a,b) shall be constructed in accordance with Art. A.10.2.4.50. to Art. A.10.2.4.60. of this Annex and the specific technical regulations.

#### **A.10. 5.4. LIMITING THE SPREAD OF FIRE AND SMOKE**

**A.10. 5.4.1.** Existing fire compartments constructed in accordance with the provisions of this Annex shall be separated from the rest of the existing construction by elements corresponding to the fire hazard category and heat load density ensuring the standard performance level (as specified in this Annex). In the same way, portions of the existing building classified in different fire hazard categories will be separated from each other.

**A.10. 5.4.2.** Within existing fire compartments, horizontal and/or vertical partitions shall be provided to prevent the spread of fire and smoke over large constructed areas.

**A.10. 5.4.3.** The construction elements used to prevent the spread of fire and smoke shall be of the type set out in Subchapter 2.3. of the Annex and in Art. A.10.9.36. to Art. A.10.9.45.

**A.10. 5.4.4.** In existing ground floor buildings classified in fire hazard categories C, D or E (BE2, BE1a,b), separation of more dangerous categories (C or D (BE2 or BE1a)) with an area greater than 400 m<sup>2</sup> or with a volume greater than 10% of the existing fire compartment is permitted, by fire class A1, A2s1d0 and fire resisting walls for a minimum of 3 hours (EI/REI180) when separating category C (BE2) from category D or E (BE1 a, b) and 2 hours (EI/REI120) respectively when separating category D (BE1a) from category E (BE1b) fire hazard (as a replacement for fire walls).

**A.10. 5.4.5.** Within existing fire compartments of existing production and/or storage buildings of fire stability levels I, II and III of fire resistance, where for functional reasons internal walls of reaction to fire class A1, A2s1d0 with a fire resistance of at least 1 hour (EI/REI60) are provided, separating rooms of the same fire category A, B or C (BE3a,b or BE2) from each other, the circulation gaps in these walls shall be protected by 45 minutes fire resisting doors (EI45-C) equipped with self-closing or automatic closing devices in case of fire. This provision is not mandatory for circulation gaps between groups of rooms in the same fire hazard category which, when added together, are less than 400 m<sup>2</sup> in area.

**A.10. 5.4.6.** In the partition walls of stairwells and lifts, in relation to rooms or groups of rooms of fire hazard category C (BE2) with an area greater than 400 m<sup>2</sup>, the circulation openings shall be protected by 45-minute fire-resistant doors (EI45-C) equipped with self-closing or automatic closing devices in the event of fire. Where the partition walls of stairwells and lifts are explosion-proof corresponding to hazard category A or B (BE3), irrespective of their area, the functional circulation gaps shall be protected in accordance with Art. A.10.2.3.46. to Art. A.10.2.3.48.

**A.10. 5.4.7.** Walls and floors separating technical and social annexes, laboratories and workshops annexed thereto from spaces in categories A or B (BE3a, b) from fire hazard, shall be explosion-resistant and the communication gaps strictly functional therein shall be protected in accordance with Article. A.10.2.3.40. to Article A.10.2.3.50.

**A.10. 5.4.8.** Partition walls between premises of fire hazard category C (BE2) and technical and social annexes, laboratories and workshops annexed thereto (excluding sanitary units) shall be of reaction to fire class A1, A2s1d0 with a fire resistance of at least 2 hours (REI/EI120). Communication gaps in these walls shall be protected by fire resistant doors for a minimum of 45 minutes (EI45-C), equipped with automatic self-closing or closing devices in the event of fire. The separation floors will be **A1, A2s1d0, fire resistant for a minimum of 45 minutes (REI45) and any gaps therein protected with fire resistant closure elements for a minimum of 45 minutes (EI45).**

**A.10. 5.4.9.** In enclosed spaces (rooms) for production in fire hazard categories C, D or E (BE2 or BE1a,b), it is permissible to construct offices for personnel directly involved in production (foremen, supervisors, management, etc.), with elements of reaction to fire class A1, A2s1d0 and which may have glazed windows facing the production space.

**A.10. 5.4.10.** In order to limit the spread of fire and smoke in enclosed spaces (rooms) with open areas (without interior walls) greater than 10,400 m<sup>2</sup>, of fire hazard categories A, B and C (BE3a,b and BE2), smoke and hot gas exhaust systems shall be provided under the ceiling (floor soffit), consisting of devices for exhausting the products of combustion and screens of reaction to fire class A1, A2s1d0, in accordance with Art. A.10.9.36. to Art. **A.10.9.45.**

#### **A.10. 5.5. SMOKE EXHAUST (SMOKE EXTRACTION)**

**A.10. 5.5.1.** Smoke evacuation (smoke extraction) by organised natural draught or mechanical ventilation shall be carried out in accordance with Art. A.10.9.1. to Art. A.10.9.30. of the Annex, subject to specific conditions.

**A.10. 5.5.2.** It is mandatory to provide smoke evacuation from existing production and storage buildings specified in the Annex. The natural-organised draught smoke evacuation devices can be arranged in the roof or in the upper third of the external walls (in which case they can only provide smoke evacuation over a maximum depth of 30 m of the room). The devices shall ensure the standard free surface in the cases and conditions laid down in the Annex, with a view to their uniform distribution.

**A.10. 5.5.3.** Existing buildings for warehouses and storage rooms with an area greater than 36 m<sup>2</sup>, classified in categories A, B or C (BE3a,b or BE2) of fire hazard, shall be provided with smoke evacuation (smoke extraction) by natural - organised draught, with devices having a total free area of at least 1% of the area of those spaces, or an appropriate mechanical system.

**A.10. 5.5.4.** Closed stairwells which do not have windows to the outside and, where appropriate, access buffers to these stairwells, shall be provided with smoke evacuation (smoke extraction) by means of an organised natural draught.

**A.10. 5.5.5.** In all situations except stairwells, natural-organised smoke extraction may be replaced by mechanical smoke extraction, constructed and carried out in accordance with the provisions of this Annex.

**A.10. 5.5.6.** When smoke and hot gases exhaust systems are provided in case of fire (according to Art. A.10.5.4.10.), smoke exhaust is no longer mandatory.

**A.10. 5.5.7.** Smoke extraction from storage spaces shall be independent of that from production spaces, regardless of how it is achieved (by organised natural draught or mechanical ventilation).

**A.10. 5.5.8.** Smoke exhaust ducts passing through spaces or rooms having functions or categories of fire hazard other than those for which they are intended shall have walls so constructed as to comply with the requirements of the functions and categories of fire hazard concerned.

#### **A.10. 5.6. ESCAPE ROUTES IN CASE OF FIRE**

**A.10. 5.6.1.** Existing production and/or storage buildings shall be provided with a sufficient number of fire escape routes, suitably laid out, designed and sized in accordance with the provisions of Art. A.10.2.5.1. to Art. A.10.2.5.74. and specific requirements. In warehouses without permanent staff, it is not mandatory to provide escape routes in the event of fire.

**A.10. 5.6.2.** In existing production and/or storage buildings, escape routes may also be considered to be those passing through:

**a)** rooms or spaces of fire hazard categories D or E (BE1 a,b), if they are used for the evacuation of persons from adjoining production spaces or their technical and social annexes, and in the cases set out in **Art. A.10.5.6.3.** and **Art. A.10.5.6.6.**;

**b)** rooms or spaces of category C (BE2) fire hazard, if they serve to evacuate persons from neighbouring production spaces, when they are not their only way of escape; the second escape route may also consist of a category C (BE2) fire space if the routes are distinct and separated from each other by fire resisting walls for a minimum of 1 hour (REI/EI60) and the circulation gaps therein are protected by appropriate closing elements equipped with self-closing or automatic closing devices in case of fire;

**c)** rooms or spaces of categories A or B (BE3a, b) of fire hazard, if they serve to evacuate persons from production or storage facilities of the same fire hazard category and do not constitute the only possibility of escape.

**A.10. 5.6.3.** Evacuation of persons from offices for those directly involved in production (foremen, supervisors, management, etc.) located in the production or storage area can only be carried out through that area.

**A.10. 5.6.4.** Gaps of access to the exhaust stairway enclosures of existing production and/or storage structures shall be protected by:

**a)** solid or reinforced glazed doors where access to the staircase is from enclosed spaces (rooms) of fire category D or E (BE1a,b);

**b)** fire resistant doors for a minimum of 45 minutes (EI45-C) when access to the staircase is from enclosed production spaces (rooms) of fire hazard category C (BE2);

**c)** pressure-ventilated buffer rooms with fire resisting doors for a minimum of 45 minutes (EI45-C) where access to the stairway is from enclosed production or storage spaces (rooms) of fire hazard categories A or B (BE3a,b);

**d)** fire-resistant doors for a minimum of 1 hour and 30 minutes (EI90-C) or buffer rooms with 45-minute doors (EI45-C) when the enclosed spaces (rooms) are for the storage of combustible materials or substances.

In all cases, the doors protecting access openings to stairwells shall be equipped with self-closing devices.

**A.10. 5.6.5.** Access openings to lifts or other vertical means of transport (landing) in existing production and/or storage buildings shall be protected with:

**a)** solid doors of reaction to fire class **A1, A2s1d0**, where access is from enclosed production and/or storage spaces (rooms) classified as fire hazard category D or E (BE1 a,b);

**b)** fire-resistant doors for a minimum of 45 minutes (EI45-C) when access is from enclosed production spaces (rooms) of fire hazard category C (BE2);

*c) pressure-ventilated buffer rooms with fire doors for a minimum of 45 minutes (EI45-C) where access is from enclosed production or storage spaces (rooms) of fire hazard category A or B (BE3a,b);*

*d) fire doors 1 hour and 30 minutes (EI90-C) or buffer rooms with fire doors 45 minutes (EI45-C), where access is from enclosed spaces (rooms) for the storage of combustible materials or substances.*

*The doors protecting access openings to landing lifts shall be fitted with self-closing devices or, where appropriate, with automatic closing devices in the event of fire.*

**A.10. 5.6.6.** *Open internal escape stairways are permitted in existing production and/or storage buildings in the following cases:*

*a) existing buildings of fire stability levels I, II and III, classified in fire hazard category E (BE1b), if they serve for the evacuation of persons from not more than two storeys and their total number does not exceed 100 persons;*

*b) existing buildings of fire stability levels I and II, of fire hazard category D (BE1a), if they serve for the evacuation of persons from not more than two storeys and their total number does not exceed 50 persons;*

*c) existing buildings of fire stability levels I and II, of category C (BE2) fire hazard, if they serve for the evacuation of one storey and the total number of persons does not exceed 30.*

**A.10. 5.6.7.** *Beams, ramps, bridges and steps of open internal escape staircases referred to in Art. A.10.5.6.6., shall comply with the fire performance requirements laid down in Art. A.10.2.4.33. In existing production buildings of fire stability levels I, II, III, IV and V irrespective of the category of fire hazard, where open stairways are provided solely for access of personnel to machinery, plant, walkways, open platforms, unprotected gap floors, etc. — not constituting permanent (fixed) working places, beams, floors and steps of these open access ladders may be reaction class to fire A1, A2s1d0 with a fire resistance of 15 minutes or more (R15).*

**A.10. 5.6.8.** *In existing production and/or storage constructions, the ramps of the subsoil stairways will be separated from the ramps of the above-ground stairs, including the ground floor of the existing construction, typically by building elements reaction class to fire A1, A2s1d0 with fire resistance established according to the density of the heat load, ensuring access to underground ramps directly from outside. Any gaps of functional access between subsoil and above-ground ramps on the ground floor shall be protected by fire resistant fastenings for 1 hour and 30 minutes (EI90-C) equipped with self-closing devices. Exceptions are strictly functional accesses to technical basements and cases where the basement is not separated from the existing building above ground by a solid, fire-resistant floor.*

**A.10. 5.6.9.** *For the evacuation of persons from the permanent working places of the above-ground production and/or storage platforms open to the premises without perimeter closures), including working spaces fitted thereto, all levels and the fire hazard category shall be provided with stairway enclosures or open escape stairways, located, constructed and constructed and constructed in accordance with the provisions of this Annex.*

**A.10. 5.6.10.** *Open external escape staircases shall be located and constructed in such a way that the movement of users cannot be blocked by flames or smoke produced in the event of a fire on the existing building (platforms) for which they are intended, or on nearby objects.*

**A.10. 5.6.11.** *In determining the exhaust streams to be provided in the event of fire, the total number of permanent personnel of the largest replacement as determined by the design shall be taken into account in existing production structures. For warehouses, the permanent staff established by the*



project is taken into account. When it is not permanently required in the warehouse, discharge conditions are not mandatory.

**A.10. 5.6.12.** *The evacuation capacity of a stream (C) shall be determined in accordance with Table 169.*

**A.10. 5.6.13.** *The maximum permissible lengths of escape routes from existing production and/or storage structures shall be as set out in Table 170.*

#### **A.10. 5.7. SIGNALLING AND FIRE-FIGHTING INSTALLATIONS**

**A.10. 5.7.1.** *Existing production and/or storage buildings shall be equipped and fitted with fire-signalling and fire-extinguishing installations and means in accordance with the provisions of this Annex and the relevant technical regulations, and additionally whenever the beneficiary so requests.*

**A.10. 5.7.2.** *In determining the equipment and fittings, account shall be taken of the use of equipment, installations, means and substances appropriate to the fire risks (previous fire hazard categories), their characteristics of occurrence and fire classes, and their compatibility, ensuring the achievement of adequate fire safety.*

**A.10. 5.7.3.** *Fire-signalling and fire-extinguishing installations in production and/or storage buildings with a high fire hazard or vulnerable to fire shall be designed in such a way as to ensure functional parameters even in the event of damage to the component parts.*

**A.10. 5.7.4.** *In existing one-piece production and/or storage buildings, floor-mounted fire hydrants may be provided, so placed and constructed that they can be used in the event of fire*

#### **A.10. 5.8. UTILITY INSTALLATIONS FOR EXISTING BUILDINGS**

**A.10. 5.8.1.** *Equipment, design and construction of upright installations<sup>III</sup> facilities relating to production and/or storage buildings shall be carried out in accordance with the provisions of the technical regulations in force and in this Annex.*

**A.10. 5.8.2.** *Utility installations associated with existing production and/or storage buildings shall be appropriate to the fire hazard categories of the premises concerned and so designed and constructed as to prevent the occurrence and spread of fire.*

**A.10. 5.8.3.** *The electrical installations shall correspond to the layout of the existing building, the fire hazard categories of the respective premises, ensuring the permitted performance levels.*

**A.10. 5.8.4.** *Heating systems and installations shall be determined on the basis of the fire hazard categories, the size of the existing constructions and the fire stability levels provided, and the use of open fire in existing rooms, spaces and buildings with a fire or explosion hazard shall be prohibited.*

**A.10. 5.8.5.** *Spaces and rooms in which combustible substances are released shall be provided with the discharge of gases, vapours, dust and dust as they are released in such a way as not to give rise to explosion hazard concentrations.*

**A.10. 5.8.6.** *Ventilation systems of rooms and spaces where flammable substances are used, handled or processed shall be independent of the other ventilation systems of the existing construction.*

**A.10. 5.8.7.** *Ventilation systems and installations related to warehouses of more than 36 m<sup>2</sup> for combustible materials or substances shall be independent of other ventilation systems or installations of the existing construction.*

### **A.10. 5.9. ACCESS, INTERVENTION AND RESCUE ROUTES**

**A.10. 5.9.1.** Existing production and/or storage structures shall have access, intervention and rescue routes in the event of fire so arranged and constructed that the intervention forces can operate as quickly and safely as possible.

**A.10. 5.9.2.** As a rule, existing production and/or storage buildings must be accessible to emergency vehicles on at least two sides. Except for existing constructions with a built-up area of up to 2,000 m<sup>2</sup>, to which intervention access may be on one side.

**A.10. 5.9.3.** The external access routes for motor vehicles, operated in accordance with the provisions of this Annex, must be such as to permit intervention in the more hazardous areas of the existing construction, at openings (protected or unprotected) in external walls, and with water supply sources.

**A.10. 5.9.4.** The internal traffic routes established for intervention in the event of fire shall be properly constructed, equipped and marked so as to be easily recognisable by the intervention personnel.

### **A.10. 5.10. EQUIPMENT WITH TECHNICAL FIRE EXTINGUISHING MEANS AND THE FIRE SERVICE**

**A.10. 5.10.1.** The existing production and/or storage buildings are equipped with technical fire extinguishing means corresponding to the fire classes in their rooms and spaces.

**A.10. 5.10.2.** As a rule, portable fire extinguishers (of the appropriate type) are provided, providing a minimum 6 Kg fire extinguisher for a maximum of 150 m<sup>2</sup> of deployed area from categories A, B or C (BE3a,b or BE2) and respectively 200 m<sup>2</sup> for categories D and E (BE1a,b), but at least two fire extinguishers per level of the existing construction.

**A.10. 5.10.3.** Portable fire extinguishers are also provided in existing rooms and spaces with a floor area of more than 500 m<sup>2</sup> and where combustible liquids may be located, recommending a minimum 50 Kg fire extinguisher for every 500 m<sup>2</sup>.

**A.10. 5.10.4.** In enclosed spaces and rooms for parking motor vehicles, it is recommended to ensure a minimum of one portable extinguisher for every 10 parking spaces, as well as transportable extinguishers in accordance with Article **A.10.5.10.3**.

**A.10. 5.10.5.** In addition to the technical means of extinction specified in Art. A.10.5.10.2. to Art. A.10.5.10.4., existing spaces, rooms, compartments and existing production and/or storage buildings shall be equipped, as appropriate, with sand boxes, fire panels, etc., depending on the substances used and the specific conditions.

**A.10. 5.10.6.** The fire-fighting equipment with which existing production and/or storage buildings are equipped and equipped shall be so arranged as to be readily accessible to personnel in the event of fire.

**A.10. 5.10.7.** The organisation of the fire brigade, its equipment and equipment shall be determined in accordance with the technical regulations depending on the fire hazard and vulnerability, as well as the level of equipment with signalling and extinguishing installations of the existing building.

**A.10. 5.10.8.** As a rule, existing constructions or existing production and/or storage building groups will have fire services set up in accordance with the relevant regulations. Beneficiaries may also establish fire brigades in smaller areas.

**A.10. 5.10.9.** The level of staffing and manning of the fire service shall be determined according to hazard, location, vulnerability to fire and the effects of a potential fire, taking into account fire safety scenarios according to specific technical regulations.

## CHAPTER 6

### PERFORMANCE SPECIFIC TO PRODUCTION AND/OR STORAGE BUILDINGS

#### A.10. 6.1. PERFORMANCE OF PRODUCTION AND/OR STORAGE BUILDING TYPES

##### *Existing buildings of the ordinary type*

**A.10. 6.1.1.** Existing production and/or storage constructions of a typical type are those that do not fall within existing single-site or armoured construction types. Existing buildings, spaces and production rooms shall have fire hazard categories established and specified. Storage rooms shall specify the fire hazard categories and classes of danger, established in accordance with the provisions laid down in this Annex.

**A.10. 6.1.2.** Existing production and/or storage constructions may be the level of fire stability **I, II, III, IV** and **V** resistance to fire, with respect to the correlation between the fire stability level, the fire hazard category, the number of levels and the area of the fire compartment, in accordance with Article. **A.10.5.2.5.** and Table 168 and the corresponding protection conditions. In cases where more combustible liquids are used than those set out in the Annex, additional technical measures shall be taken in accordance with their specific regulations.

**A.10. 6.1.3.** Ordinary existing constructions may be located independently or grouped or merged with other existing production and/or storage structures within the limits of the permitted fire compartments under the conditions laid down in this Annex. Existing production and/or storage constructions, as a rule, shall not be grouped together or merged with existing civil (public) buildings and shall be partitioned in accordance with the provisions of this Annex. The exception shall be made to existing mixed-function constructions, where appropriate protective measures shall be ensured.

**A.10. 6.1.4.** Existing normal production and/or storage constructions shall be placed in relation to other neighbouring existing constructions at the safety distances referred to in Article. **A.10.2.2.2.** and Table 145 or shall be divided by fire bulkheads and, where applicable, fire or explosion resistant in accordance with the provisions laid down in this Annex.

**A.10. 6.1.5.** Compliance with existing production and/or storage structures shall aim to ensure that spaces with dangerous fire hazard categories are arranged as far as possible in separate areas and adequate fire protection measures are ensured so that large areas built up are not affected in the event of fire or endanger neighbouring objects or are endangered by neighbours.

**A.10. 6.1.6.** Existing production and/or storage constructions shall be made of materials and building elements corresponding to the level of fire stability provided, in accordance with Article. **A.10.2.1.8** Article. **A.10.2.1.14.** in such a way that it does not lead to the slight spread of fire.

**A.10. 6.1.7.** Within the fire compartments, walls and floors functionally provided shall also ensure that the spread of fire and smoke is limited as specified in this Annex.

**A.10. 6.1.8.** Partitions (walls, floors) shall be provided between existing, functionally independent but pooled parts of buildings within an existing fire compartment **A1, A2s1d0** with fire resistance determined according to the density of the highest heat load of adjacent spaces, not less than 1 h and 30 minutes (**EI/REI90** walls and **REI90** floors). When separating rooms or spaces with an explosion hazard – categories A or B (**BE3a, b**) – these partitions shall also be explosion-resistant.

**A.10. 6.1.9.** Storage rooms for combustible materials and substances with an area greater than 36 m<sup>2</sup> shall be compartmentalised in relation to the rest of the building in accordance with the provisions laid down in this Annex. In these storage rooms, and in closed (windowless) escape stairwells, it is mandatory to provide smoke evacuation (smoke extraction) as specified in Art. **A.10.9.1.** to Art. **A.10.9.35.**

**A.10. 6.1.10.** *In existing production and/or storage buildings, properly distributed escape routes for persons shall be provided, designed, constructed and dimensioned in accordance with the provisions of Art. A.10.2.5.1. to Art. A.10.2.5.74. and Art. A.10.5.6.1. to Art. A.10.5.6.13. It is mandatory to provide escape routes in the case of fire in warehouses without permanent places of guns.*

**A.10. 6.1.11.** *Existing regular production and/or storage facilities shall be equipped with signalling and fire-fighting installations, in accordance with the provisions of the technical regulations. In addition to the mandatory scope of equipment, beneficiaries may determine the provision of such facilities in other cases.*

**A.10. 6.1.12.** *Utility installations relating to existing buildings (electrical, thermal, sanitary, ventilation, etc.) shall be provided and carried out in accordance with the provisions of the specialised regulations.*

**A.10. 6.1.13.** *For fire intervention, existing buildings used for production and/or storage shall have external access and circulation routes for fire-fighting vehicles, as a rule on at least two sides. The exception is existing constructions with a built-up area of up to 500 m<sup>2</sup>, which can be accessible on one side. The interior routes for fire-fighting personnel shall be suitably designed and constructed, as a rule, from the functional circulation of the existing building. Interior escape routes shall provide easy access to established fire hazard areas and rooms and to the fire safety installations and devices provided, and shall be appropriately marked.*

**A.10. 6.1.14.** *The equipping of existing buildings and installations with technical means of fire fighting and the establishment of the fire brigade shall be ensured in accordance with Art. A.10.5.10.1. to Art. A.10.5.10.9.*

#### **Existing monobloc constructions**

**A.10. 6.1.15.** *Existing monobloc production and/or storage structures are considered to be those which have a width of more than 72 m and the built up area of more than 20,000 m<sup>2</sup>. The grouping or combination of several fire compartments, separated by fire walls and having different levels of fire stability (I to V), does not constitute an existing single building within the meaning of this Annex, but a grouping of independent fire compartments, each ensuring the fulfilment of specific fire safety requirements. Existing fire compartments will typically include independent activities to which appropriate protective measures are applied.*

**A.10. 6.1.16.** *Existing monobloc buildings shall meet the requirements for classification in fire stability level I or II, and it is recommended that they be separated into fire compartments as specified in Art. A.10.5.2.5 and Table 168 of the Annex. Existing monoblock constructions will meet their specific fire performance requirements.*

**A.10. 6.1.17.** *Existing single-site constructions shall be located independently, at least at the normal safety distances (set out in the Annex) from other neighbouring constructions, and should be doubled.*

**A.10. 6.1.18.** *Existing portions of buildings with a high fire hazard shall be arranged in separate areas, usually adjacent to their perimeter enclosures and grouped together as far as possible.*

**A.10. 6.1.19.** *In existing monoblock buildings, spaces and fire compartments of fire hazard categories A, B and C (BE3a,b and BE2) shall be provided in their upper parts (upper third of the external walls and/or roof) with smoke extraction devices (smoke extraction) in case of fire, made in accordance with Art. A.10.9.1 to Art. A.10.9.35., having a total area of at least 0.2% of the area of the rooms or compartments concerned, or with mechanical exhausts.*

**A.10. 6.1.20.** *In existing buildings and existing enclosed spaces (without internal partitions), with clear areas greater than 10,400 m<sup>2</sup> of existing monoblock buildings, and classified in fire hazard*

categories A, B or C (BE3a,b or BE2), smoke and hot gas exhaust systems shall be provided to limit the spread of fire, in accordance with the provisions of Art. A.10.9.36. to Art. A.10.9.45.

**A.10. 6.1.21.** The existing production and/or storage buildings, monoblock, shall have provided, adequately sized, distributed, composed and realized user escape routes, according to the provisions of Art. A.10.2.5.1. to Art. A.10.2.5.74. and Art. A.10.5.6.1. to Art. A.10.5.6.13.

**A.10. 6.1.22.** The equipping and fitting of existing monoblock production and/or storage buildings with fire-signalling and fire-extinguishing installations and means shall be carried out in accordance with the provisions of the relevant technical regulations, depending on the categories of fire hazard determined, the level of fire stability provided and their vulnerability to fire. In existing monoblock constructions, underground (underfloor) internal fire hydrants connected to the external fire hydrant network may also be provided, so located that they can be used for extinguishing purposes.

**A.10. 6.1.23.** The utility installations for the existing monoblock constructions will be designed and built according to their specific technical provisions.

**A.10. 6.1.24.** Existing monoblock buildings shall be equipped with technical means of extinguishing appropriate to the fire classes of the premises (portable extinguishers, transportable extinguishers, sandboxes, fire panels, etc.) in accordance with the regulations.

**A.10. 6.1.25.** Existing monoblock production and/or storage buildings classified in fire hazard categories A, B or C (BE3a,b or BE2) shall have fire services established and organised in accordance with the relevant regulations. The level of equipment and staffing shall be determined in accordance with specific regulations.

#### **Existing armoured constructions**

**A.10. 6.1.26.** Existing armoured production and/or storage buildings, including armoured rooms with an area of more than 700 m<sup>2</sup>, shall be constructed and built in accordance with the provisions of this Annex, fulfilling the correlation conditions laid down in Art. A.10.5.2.5 and Table 168.

**A.10. 6.1.27.** Existing armoured constructions may be independently located or grouped or merged with other constructions.

**A.10. 6.1.28.** Grouping or merging of existing armoured buildings with other existing production and/or storage buildings may be carried out within the fire compartment limits laid down in Art. A.10.5.2.5. and Table 168, ensuring separation of functions with vertical and where appropriate, horizontal building elements (walls and floors) of reaction to fire class A1, A2s1d0 and fire resistance determined according to the heat load density of adjacent spaces. Existing civil (public) buildings to which they adjoin shall be separated by appropriate partition walls, and where they are incorporated shall be separated by fire-resistant walls and floors as required.

**A.10. 6.1.29.** Existing free-standing armoured buildings shall be located in relation to other neighbouring buildings at the safety distances specified in Art. A.10.2.2.2 and Table 145 or appropriately compartmentalised from them.

**A.10. 6.1.30.** Existing fireproofed buildings shall be so designed as not to facilitate the spread of fire over large areas, and spaces of high fire danger shall, as far as possible, be arranged in separate areas.

**A.10. 6.1.31.** Existing armoured buildings (including armoured rooms with an area greater than 700 m<sup>2</sup>) in fire hazard categories A, B and C (BE2a,b and BE2) shall be provided with devices to ensure the escape of smoke in the event of fire (smoke extraction). The devices will have the total free area of at least 0.2% of the floor area of the respective spaces or compartments, being composed, distributed and made according to the provisions of Art. A.10.9.1. up to Art. A.10.9.35. Smoke evacuation (smoke extraction) can also be ensured mechanically.

**A.10. 6.1.32.** Where existing buildings or open spaces (without internal partitions) with an area greater than 10,400 m<sup>2</sup> and classified in fire hazard categories A, B and C (BE3a,b and BE2), smoke and hot gas exhaust systems shall be provided to limit the spread of fire, in accordance with Art. A.10.9.36. to Art. A.10.9.45.

**A.10. 6.1.33.** The existing armoured production and/or storage buildings will have ensured user evacuation routes in case of fire, properly distributed, made and made, according to the provisions of Art. A.10.2.5.1. to Art. A.10.2.5.74 and Art. A.10.5.6.1. to Art. A.10.5.6.13.

**A.10. 6.1.34.** Existing armoured constructions shall be equipped and equipped with fire signalling and fire-fighting facilities and means, in accordance with the provisions of the technical regulations, depending on the categories of fire hazard and fire vulnerability. In addition to the mandatory scope of equipment, the beneficiaries may determine in other cases the provision of fire signalling and fire-fighting systems.

**A.10. 6.1.35.** Utility installations related to existing armoured constructions will be designed according to their specific technical regulations.

**A.10. 6.1.36.** For the intervention from the outside in case of fire, the existing armoured constructions will have the access of emergency vehicles at least on two sides. Access to and movement of intervention personnel in the existing construction shall be ensured by functional access to the existing construction or through access panels provided in (external) perimeter closure walls, not more than 40 m apart, easily removable from the outside and visibly marked to be easily recognisable.

**A.10. 6.1.37.** Existing armoured constructions shall be equipped with technical means of extinguishing appropriate to the fire classes in the spaces concerned in accordance with the regulations.

**6.1.38.** Existing armoured buildings shall have fire services in accordance with the regulations, depending on the area constructed and developed, the fire hazard categories, importance and vulnerability to fire.

## **A.10. 6.2. PERFORMANCE OF EXISTING STORAGE BUILDINGS**

### **Common provisions**

**A.10. 6.2.1.** Existing storage buildings and, in general, material and substance warehouses will have established fire hazard categories, according to Art. A.10.2.1.4. to Art. A.10.2.1.7., and hazard classes of the respective materials and substances, according to Art. A.10.6.2.19.

**A.10. 6.2.2.** When making deposits related to existing civil (public) buildings, the specific provisions of these existing buildings are also respected.

**A.10. 6.2.3.** The incorporation of storage rooms for combustible materials and substances in existing production structures and existing civil (public) buildings shall be permitted where functional considerations so require, provided that the conditions and protective measures set out in this Annex are ensured.

**A.10. 6.2.4.** It is allowed to store different materials and substances in the same room, if their mixture or respective vapours do not present a risk of self-ignition or explosion, and in case of fire, the same extinguishing products can be used.

**A.10. 6.2.5.** Stores of materials and substances may be located independently, grouped or pooled when they are in existing enclosed constructions and located only independently when they are closed deposits.

**A.10. 6.2.6.** Existing freestanding storage buildings shall be placed in relation to neighbouring objects at the safety distances laid down in Art. A.10.2.2.2. and Table 145 and in technical

regulations, or shall be compartmentalised as specified in this Annex. Open storage areas shall be set back from neighbours at the standard distances laid down in this Annex and in their specific regulations. Existing enclosed storage buildings grouped or combined with each other or with other buildings shall be separated in accordance with the provisions of this Annex.

**A.10. 6.2.7.** Existing warehouse buildings that the beneficiary considers important or of high value should be located independently.

**A.10. 6.2.8.** In the location of warehouses, consideration shall be given to limiting the possibility of a fire produced in a warehouse endangering major neighbouring buildings or installations or populated centres, as well as the burning of the warehouse due to a fire produced on a neighbouring object.

**A.10. 6.2.9.** Stores of combustible materials and substances shall be located in such a way that, as far as possible, the direction of the dominant wind is not towards neighbouring constructions, and where this is not technically feasible or justified, appropriate protective measures shall be taken.

**A.10. 6.2.10.** Combustible liquid stores, typically, shall be located in areas lower than neighbouring constructions in such a way that it is not possible to discharge or drain liquids and spread of fire to its surroundings, or appropriate protective measures (dykes, protective walls, etc.) shall be provided. The location of these warehouses will also ensure distances and protective measures from watercourses, lakes, ponds, baths, etc. located in the vicinity.

**A.10. 6.2.11.** The storage of combustible materials and substances is carried out according to their physical and chemical characteristics so that they do not generate fire and can be extinguished with the same extinguishing products.

**A.10. 6.2.12.** The storage of solid combustible materials together with combustible liquids or gases is generally not permitted. Except as permitted in this Annex.

**A.10. 6.2.13.** When storing materials or substances which present a danger of self-ignition, it is mandatory to determine the duration of their storage and to take the necessary measures to check their temperature rise.

**A.10. 6.2.14.** Pipes carrying combustible fluids (liquid gases), heating and electrical networks for other consumers may not pass through warehouses or storage rooms. Where it is not technically possible or justified, these penetrations shall be made in closed ducts with walls and floors of reaction to fire class A1, A2s1d0, with a fire resistance corresponding to the separation conditions imposed by the warehouse.

**A.10. 6.2.15.** The laying of pipes for water or for products containing water or on which water can condense, in storage areas for materials or substances which react dangerously with water, is prohibited.

**A.10. 6.2.16.** Combustible materials and substances may be kept in production premises and rooms only in the minimum quantities required for the technology flow, as specified by the design theme. The storage of combustible materials and substances in larger quantities shall be carried out in rooms designed, constructed and protected in accordance with the provisions of this Annex.

**A.10. 6.2.17.** The warehouses shall be provided with access, functional and escape routes so dimensioned and designed as to limit the possibility of fire spreading and at the same time allow fire-fighting intervention. For warehouses without permanent workplaces (visited a maximum of 8 times per shift), it is not mandatory to provide escape routes in case of fire.

**A.10. 6.2.18.** Stores of combustible materials or substances shall be equipped with fire signalling and fire-fighting facilities appropriate to the stored materials and substances, as well as their quantity and importance, in accordance with the provisions of this Annex and the relevant technical regulations.

**A.10. 6.2.19.** Existing constructions and existing storage rooms for materials and substances shall be carried out in accordance with Article. **A.10.6.2.1.** having regard to the fire hazard category and their hazard class, determined by their contribution to the appearance and development of fires and their sensitivity to the effects of fires, as set out in Table 171. Responsibility for the adoption of measures regarding the storage of materials/products and substances with particularly high danger and those with high danger specified in the table at letter F (combustible liquids with flammability temperatures between 50-100 °C) falls to the designer and the investor / the beneficiary (regarding fire safety compliance measures regarding the proper storage of substances or mixtures and the provisions regarding their dangerousness). The designer having regard to the design theme and the type, quantities and possible interaction of the stored materials/products and substances made available by the beneficiary according to the specific characteristics of the manufacturer, together with the technology, shall ensure compliance measures in relation to the stored products or mixtures and their dangerousness, for the adoption of protective and compliance measures on the fire safety line of the spaces concerned. In all cases the designers will also apply the methodology for categorisation of stored goods (as set out in SR EN 12845); and where water is not indicated as an extinguishing substance, automatic extinguishing systems with other substances referred to in the profile standard shall be provided. Fire risk classification of spaces, rooms, fire compartments and production and/or storage buildings with stored materials/products and substances of the hazard class: P.1, P.2, P.3 and P4 (excluding combustible liquids with flammability temperatures between 50 and 100 °C) are to be determined in the agreement **and** with calculation of heat load density and the fire limitation measures provided for in this Annex are mandatory.

**A.10. 6.2.20.** Combustible liquids shall be classified as reaction to fire classes according to their vapour flammability temperature as set out in Table 172.

**A.10. 6.2.21.** Depending on the storage capacity and hazard class of stored fuel liquids, the categories of combustible liquid storage shall be determined in accordance with Table 173.

**A.10. 6.2.22.** Liquid deposits in tanks, according to their execution, can be:

**a)** above ground, when the bottom of the tanks is above the surrounding ground, at the same level as it or at a depth less than half the height of the tanks, and in cases where the level of liquid is above the elevation of the surrounding ground by at least 2.00 m;

**b)** semi-buried, where the bottom of the tanks is buried more than half their height and the maximum possible level of the combustible liquid is not more than 2.00 m above the level of the surrounding ground;

**c)** buried, when the upper part of the tanks is at least 0.20 m lower than the elevation of the surrounding ground.

Note:

The elevation of the surrounding land shall be considered as the minimum land level for a distance of **6.00 m** from the tank mantle.

**A.10. 6.2.23.** In existing constructions or existing building rooms, in the cases and under the conditions permitted by this Annex, combustible liquids may be stored in tanks or containers (packaging). Irrespective of how combustible liquids are stored, it is mandatory to specify the category of storage, according to Art. A.10.6.2.21., and the provision of the specific protective measures specified in this Annex and the specific technical regulations so as to ensure that the spread of fire is limited and that it can be extinguished effectively.

**A.10. 6.2.24.** The storage of liquids with a flammable vapour temperature below 28 °C, in quantities greater than 2.00 m<sup>3</sup> and stored in containers and packages, is recommended to be carried out in above ground constructions.



### **Existing closed deposits**

**A.10. 6.2.25.** Existing enclosed buildings for the storage of materials and substances, (enclosed warehouses), may be of fire stability levels I to V, depending on the fire hazard category and the hazard class established according to Art. A.10.6.2.19., provided that the correlation allowed in Art. A.10.5.2.5. and Table 168 between the fire stability level, the number of levels and the constructed area of the fire compartment and the specific provisions for combustible liquids. Exceptions are the situations specified in this Annex.

**A.10. 6.2.26.** If the construction of the existing warehouse is monoblock or armoured, it is mandatory to comply with the corresponding provisions of Art. A.10.6.1.15. to Art. A.10.6.1.38.

**A.10. 6.2.27.** Existing closed buildings established by the beneficiary, in which materials, substances, products, objects of value or high fire risk are stored, it is recommended that they be subdivided by fire resistant elements in areas of maximum construction **750 m** and equipped with fire signalling and fire-fighting systems.

**A.10. 6.2.28.** Existing closed storage structures shall be constructed with fire resistant floors in accordance with the provisions laid down in this Annex in such a way as to prevent the propagation of fires between construction levels. Any functional gaps in the floor shall be protected with appropriate closures. Exceptions are warehouses with mechanised storage platforms, without permanent working places, where the platforms (total or partial) may be materials and elements of reaction to fire class A1, A2s1d0, fire resistant for a minimum of 15 minutes (R/REI15), if automatic fire extinguishing systems are provided on each level.

**A.10. 6.2.29.** Existing construction of higher deposits of **6.00 m** they must meet the conditions and performance levels laid down in the specialised technical regulations corresponding to the density of the heat load and the danger of the spread of fire. As a rule, these high-stack stores must be equipped with automatic fire-fighting systems.

**A.10. 6.2.30.** Storage rooms for combustible materials and/or substances of hazard class P4 and P5 with a floor area greater than 36 m<sup>2</sup> shall be separated from the rest of the construction with vertical elements (walls) of reaction to fire class A1, A2s1d0, having a fire resistance corresponding to the thermal load density according to Art. **A.10.2.3.2**. When located in existing multi-storey buildings, they are also separated by fire reaction class A1, A2s1d0, fire resistant for a minimum of 1 hour and 30 minutes (REI90). The required circulation or functional gaps of the separation elements (walls, floors) shall be protected by appropriate fire resistant elements as prescribed in this Annex, depending on the type of penetrating element (wall, floor).

**A.10. 6.2.31.** Storage rooms for combustible materials and/or substances of hazard classes P2 and P3 with a floor area greater than 36 m<sup>2</sup> shall be separated from the rest of the building by walls of reaction to fire class A1, A2s1d0 with a minimum fire resistance of 1 and 1/2 hours (EI/REI90) and, where appropriate, floors of reaction to fire class A1, A2s1d0 with a minimum fire resistance of 1 hour (**REI60**). Circulation or functionally necessary gaps in separating elements shall be protected with fire-resistant elements for a minimum of 45 minutes (EI45-C), equipped with self-closing or automatic closing devices in case of fire.

**A.10. 6.2.32.** Storage rooms for materials and/or substances of hazard class P1 shall be separated from the rest of the existing construction by walls and, where appropriate, floors of reaction to fire class A1, A2s1d0, and the circulation or functional gaps therein shall be protected by non-combustible closing elements.

**A.10. 6.2.33.** Buffer stores of combustible materials and substances of hazard classes P4 and P5, other than those in the process stream, shall be separated from the rest of the existing construction by walls and, where appropriate, floor slabs of reaction to fire class A1, A2s1d0 with a minimum fire resistance of 3 hours for walls and 1 1/2 hours for floor slabs (EI/REI180 walls and REI90 floor slabs). The required circulation or functional gaps of the separation elements shall be protected by fire resistant fastenings for 1 hour (**EI60-C**) equipped with automatic self-closing or

closing devices in the event of fire. For combustible materials and substances of hazard classes P2 and P3, walls and partitions may be of reaction to fire class A1, A2s1d0 with 1 hour fire resistance (EI/REI60 walls and REI60 partitions) and the necessary circulation or functional gaps protected with 45 minutes fire resistant closures (EI45-C) equipped with self-closing devices, or automatic closure in case of fire. For hazard class P1, partitioning can be achieved with walls and floor boards of reaction to fire class A1, A2s1d0 and the communication gaps therein protected by non-combustible closures.

**A.10. 6.2.34.** In storage rooms for combustible materials of hazard classes P3, P5 and P4, no office gaps shall be permitted for finishing, testing or repairing stored products and for the distribution of combustible liquids. Such spaces shall be fitted out in their own rooms, separated from the storage rooms by walls and, where appropriate, fire reaction class A1, A2s1d0, fire-resistant floorboards in accordance with Art. A.10.2.2.2. Shipping reception areas are usually separated in the same way.

**A.10. 6.2.35.** Spaces for receiving and dispatching, offices, for loading, finishing or repairing the stored products, as well as for the distribution of combustible liquids, shall be separated from the storage rooms for combustible materials and substances of hazard classes P3, P4 and P5 respectively by walls and floors of reaction to fire class A1, A2s1d0, respectively fire resistant for at least 2 hours for walls and 1 hour for floors (EI/REI120 walls and REI60 floors). Traffic gaps in separation walls from storage shall be protected by fire resistant doors for 45 minutes (EI45-C), equipped with automatic self-closing or closing devices in the event of fire.

**A.10. 6.2.36.** In duly justified technical cases, fixed windows shall be permitted in office and reception walls – dispatch from warehouses P3, P4 or P5 reaction class to fire A1, A2s1d0 fire resistant at least 45 minutes (EI45) or ordinary windows, if protected with fire resistant shutters for a minimum of 45 minutes (EI45-C), equipped with automatic closing devices in the event of fire.

**A.10. 6.2.37.** An exception to Art. A.10.6.2.35. and Art. A.10.6.2.36., the reception and dispatch areas of storage rooms of hazard classes P3, P4 and P5, where the same fire safety measures are provided as for the corresponding storage rooms, where separation from the storage room is no longer required. Also, in warehouses with class P1 and P2 hazardousness of the stored materials and substances, it is not mandatory to separate the reception-shipping areas and offices.

**A.10. 6.2.38.** Existing above-ground enclosed buildings for the storage of combustible liquids shall be constructed of materials and construction elements of reaction to fire class A1, A2s1d0, fire resistant in accordance with the specifications of this Annex and the relevant regulations, ensuring fireproof and, where appropriate, explosion-proof partition of storage rooms with a maximum capacity of 50 ml of liquids of classes LI or LII (or their equivalent for LIII and LIV).

**A.10. 6.2.39.** Rooms for the storage of a maximum of 20 m<sup>3</sup> of combustible liquids necessary for the functional consumption of the utility installations related to the construction (heating plant, generator, hot air heating plant, etc.), as well as those related to the operation of certain equipment (lifts, platforms, etc.) shall be separated from the rest of the construction by walls and floors of reaction to fire class A1, A2s1d0 with a fire resistance of at least 2 hours (EI/REI120 walls and REI120 floors).

**A.10. 6.2.40.** The rooms referred to in Art. A.10.6.2.39. may have a manhole in the separating elements from the rest of the existing construction, protected by a fire resistant closure for a minimum of 45 minutes (EI45-C) and provided with a parapet (threshold) of such a height that it is not possible for liquid to escape from the room in the event of damage. Tanks are provided with pre-flame and vent pipe with flame arrester arranged outside. In these rooms it is not mandatory to provide pressure relief panels and smoke extraction devices (smoke extraction) and if lighting is provided it shall correspond to the fire hazard category.

**A.10. 6.2.41.** In addition to the day tank with a maximum capacity of 2,00 m<sup>3</sup> liquid fuel located in the thermal power plant and the one allowed in art. 6.2.39., the necessary liquid fuel reserve shall be provided outside the existing construction, according to the specific technical regulations.

**A.10. 6.2.42.** Storage of solid fuel for thermal power plants with a maximum capacity of 2,00 m<sup>3</sup> shall be carried out under the conditions laid down in Art. A.10.6.2.39., communication with the boiler room being permitted through fire doors for a minimum of 45 minutes (EI45-C). Exceptions are thermal power plants with large capacities, which comply with the provisions of the specific technical regulations.

**A.10. 6.2.43.** Existing bunkers for solid fuels and the supply funnels of combustion plants for thermal power stations shall be of reaction to fire class A1, A2s1d0, with appropriate protection and extinguishing measures. When bunkers are larger than 3.00 m<sup>3</sup> they are separated from the rest of the existing construction by walls and floor slabs of reaction to fire class A1, A2s1d0, fire resistant for at least 2 hours (EI/REI120 walls and REI120 floors).

**A.10. 6.2.44.** Closed storage rooms (existing buildings or rooms with an area greater than 36 m<sup>2</sup>) for combustible materials or substances shall be provided with smoke exhaust devices made in accordance with Art. A.10.5.5.1. to Art. A.10.5.5.7., providing 1% of the floor area, and where storage rooms of categories A, B, or C (BE3a,b or BE2) and hazard classes P3, P4 or P5 have a free area (without internal walls) greater than 10,400 m<sup>2</sup>, they shall be provided with smoke and hot gas exhaust systems according to Art. A.10.9.36. to Art. A.10.9.45. Exceptions are as specified in the annex.

**A.10. 6.2.45.** Existing enclosed storage facilities for combustible materials and substances shall be equipped with fire signalling and fire-fighting systems in accordance with the relevant technical regulations, ensuring that the technical means of extinguishing in the event of fire are also adequately fitted.

#### **Existing open deposits**

**A.10. 6.2.46.** The siting and construction of existing open storage facilities for solid, liquid or gaseous combustible materials and substances shall be carried out in accordance with the provisions of this Annex and the specific technical regulations, ensuring the limitation of losses in the event of fire and appropriate intervention conditions.

**A.10. 6.2.47.** Where combustible materials and substances of different sorts are stored on the same platform, they shall be arranged in such a way as not to encourage the spread of fire over large areas.

**A.10. 6.2.48.** Existing open deposits of combustible liquids are typically located in areas below neighbouring objects. Where the location is at a higher elevation, measures shall be taken to prevent the ingress of combustible liquids and the transmission of fire to neighbouring objects. In the case of siting near water, measures shall be taken to prevent flooding of stores and to prevent the escape of combustible liquids into them.

**A.10. 6.2.49.** Existing tanks without double walls or groups of such above-ground or semi-buried tanks shall be provided with a containment vessel bounded by dykes or walls of reaction to fire class A1, A2s1d0 continuous non-combustible, which can withstand the mechanical and technical stresses produced during damage and fire. Existing holding tanks shall be sized and constructed so as not to allow liquids to spill out of them.

**A.10. 6.2.50.** Storage of combustible liquids in packaging or containers may be carried out on open platforms made of materials of reaction to fire class A1, A2s1d0, located above the level of the surrounding ground and provided with drainage channels.

**A.10. 6.2.51.** Open stores of combustible materials and substances shall be equipped with first intervention means and shall be equipped with signalling and fire-fighting installations in accordance with the relevant technical regulations.

**A.10. 6.2.52.** For access and operational intervention in the event of fire, open warehouses shall have access to all sides.

## SECTION IV

### EXISTING BUILDINGS WITH MIXED FUNCTIONS

#### CHAPTER 7

#### PERFORMANCE COMMON TO EXISTING MIXED-FUNCTION BUILDINGS

##### A.10. 7.1. FIRE RISK AND FIRE HAZARD CATEGORY, FIRE STABILITY LEVEL

###### **Risk and fire hazard category**

**A.10. 7.1.1.** Existing areas, rooms, fire compartments and existing free-standing mixed-function buildings shall have the specific fire risks and, where appropriate, hazards determined and specified as provided for in Art. A.10.2.1.1. to Art. A.10.2.1.7. of this Annex.

**A.10. 7.1.2.** For civil (public) functions, fire risks shall be established and, for production and/or storage, the risks of fire shall be expressed by fire hazard categories as determined in accordance with the provisions of this Annex.

**A.10. 7.1.3.** In an existing mixed-function construction, the portions of existing civil (public) buildings, suitably separated according to the Annex from those with production and/or storage activities, shall be considered to be the largest fire risk in that portion, which accounts for at least 30% of its area. Where in the existing mixed-function building, the developed area of the portions with public civil functions represents more than 60% of the total developed area of the existing building, the existing building in question shall be considered civil (public) and with the risk established in accordance with the first paragraph, and as a whole shall meet its common and specific performance as set out in this Annex.

**A.10. 7.1.4.** Portions of existing buildings with production and/or storage activities within an existing mixed-function building, appropriately separated according to the Annex from those with civil (public) functions, are considered with the most dangerous fire category representing more than 30% of their developed area. Where, in the existing mixed-function building, the floor area of the production and/or storage activities represents more than 60% of the total floor area of the existing building, it shall be considered as production and/or storage having the fire hazard category established in accordance with the first paragraph, and as a whole it shall comply with the common and specific performance requirements set out in this Annex (Parts III and IV).

###### **Fire stability level**

**A.10. 7.1.5.** Existing mixed-function constructions shall have the level of fire stability provided and shall be specified in the documentation. When determining the fire stability level, the provisions of Art. A.10.2.1.8. to Art. A.10.2.1.14. and, where appropriate, the specific conditions of the existing type of construction.

##### A.10. 7.2. LOCATION AND FIRE COMPLIANCE

###### **Location**

**A.10. 7.2.1.** Existing buildings with mixed, independent, combined or grouped functions in accordance with the general provisions of the Annex shall be located at the safety distances set out in Art. A.10.2.2.1. to Art. A.10.2.2.3., taking into account the assembly as well as the fire risks (hazards) of the parts of the existing construction from which the distances are to be provided. Where the prescribed safety distances cannot be provided, they shall be subdivided as specified in the Annex.

**A.10. 7.2.2.** Existing mixed-function buildings comprising activities with a high fire risk or hazard or a large number of people are recommended to be located independently at the prescribed safety distances from neighbours.

### **Fire compliance**

**A.10. 7.2.3.** The fire compliance of existing buildings with mixed functions, civil (public), production and/or storage, as far as possible, shall aim at the separate arrangement of functions and at their specific protection measures, ensuring the fulfilment of the correlation conditions between fire hazard risk (category), fire stability level, number of levels and built-up area, as provided for in this Annex, taking into account the provisions of Art. A.10.7.1.1. to Art. A.10.7.1.4.

**A.10. 7.2.4.** Where an existing civil (public) building comprises different and functionally independent civil (public) activities, the most stringent appropriate performance conditions set out in the Annex for those civil (public) functions shall be met. If these functions are located in an existing tall, very tall, or crowded building, their specific performance requirements will also be met.

**A.10. 7.2.5.** In existing buildings with mixed civil (public), production and/or storage functions, the most stringent performance conditions set out in the Annex for those functions shall be met in each bay, taking into account their implications for the existing building as a whole.

**A.10. 7.2.6.** By complying with existing buildings with mixed functions, it will be ensured that the possibilities for the propagation of fire and smoke in both burnt and existing building sections with other functions are limited, taking appropriate protective measures.

**A.10. 7.2.7.** In existing multi-storey buildings with mixed civil (public) functions of any kind, it is not permitted to have spaces or rooms with an explosion hazard category A or B (BE3a,b) fire hazard on their lower levels (above or below ground).

**A.10. 7.2.8.** The arrangement of explosion hazard spaces and rooms of categories A or B (BE3a, b) of fire hazard in existing buildings with mixed production and/or storage functions is recommended at the last above-ground level and with appropriate protective measures taken.

### **A.10. 7.3. CONSTRUCTIVE ASSEMBLIES**

**A.10. 7.3.1.** Existing mixed-function constructions shall be made of materials and building elements corresponding to the level of fire stability required to meet the standard correlation conditions in such a way that they do not easily spread fire.

**A.10. 7.3.2.** Any internal gaps of the building elements shall have interrupted continuity in accordance with the provisions laid down in this Annex, so as not to favour the propagation of fire and smoke over large areas of construction and between different functions or destinations.

**A.10. 7.3.3.** The different functions of the existing construction shall be separated by vertical and, where appropriate, horizontal elements of the reaction to fire class, with the fire resistance determined in accordance with the provisions laid down in this Annex, depending on the level of the highest fire hazard (category), the heat load density and the performance conditions specific to the existing building function (destination) and type.

**A.10. 7.3.4.** When the existing parts of construction with distinct civil (public) functions of production and/or storage are composed and carried out, the performance conditions specific to each function shall be met, in accordance with the provisions of this Annex, and the entire existing construction must ensure that the performance conditions corresponding to the assembly considered are met, in accordance with Article A.10.7.1.1. in art. A.10.7.1.4.

**A.10. 7.3.5.** Storage rooms for combustible materials and substances shall be constructed, carried out and separated from the rest of the existing construction with mixed functions corresponding to

their general and specific provisions. Exceptions are storage rooms with a maximum area of 36 m<sup>2</sup> where no special protection measures are required.

**A.10. 7.3.6.** In situations permitted by this Annex, rooms with an explosion hazard, fire hazard category A or B (BE3a,b), arranged in such a way as not to endanger the existing construction, must be designed, constructed and provided with the necessary protective measures in accordance with the regulations in the Annex.

**A.10. 7.3.7.** Existing building portions which comprise or fall within the category of crowded rooms shall be constituted in accordance with their specific provisions, separating them from other functions of the existing construction by vertical and, where appropriate, horizontal building elements corresponding to the Annex.

**A.10. 7.3.8.** Underground parts of existing buildings with mixed functions, in which separate functions are provided, will also meet the specific conditions.

**A.10. 7.3.9.** The composition of existing buildings and building elements shall comply with the common performance conditions laid down in Article. **A.10.2.4.1.** up to Article **A.10.2.4.60.** as well as those specific to the respective functions.

#### **A.10. 7.4. LIMITING THE SPREAD OF FIRE AND SMOKE**

**A.10. 7.4.1.** The independent functions arranged in the existing construction shall be separated from each other and from the common traffic and escape routes by fire resistant components of construction in accordance with the provisions of this Annex. Where these functions constitute separate fire compartments, they shall be separated, as appropriate, by fire-resistant or explosion-proof partitions.

**A.10. 7.4.2.** The arrangement, design and construction of partitioning elements shall ensure that the spread of fire and smoke is limited to adjacent functions during normal times and, within the same function, that the spread of fire and smoke is limited to large areas.

**A.10. 7.4.3.** Building elements used to limit the spread of fire and smoke shall meet the general and specific performance conditions specified in the Annex, depending on their role.

**A.10. 7.4.4.** Separation of different functions in existing double-deck buildings shall be ensured by vertical and horizontal elements (walls and floors) constructed and constructed in accordance with the most hazardous adjacent space, and any gaps in circulation or functional gaps in the separation elements shall be protected in accordance with the provisions laid down in this Annex.

**A.10. 7.4.5.** Limiting the spread of fire between different functions in an existing multi-storey building will also be ensured on the facades (through the outside of the perimeter enclosures), by making full portions between successive gaps in the facades (which overlap), or by other appropriate protective measures (canopies, screens, etc.).

**A.10. 7.4.6.** The common traffic and escape routes (horizontal and, where appropriate, vertical) of the existing construction with mixed functions shall be separated from the different adjacent functions corresponding to their risk or fire hazard category, as specified in this Annex. The circulation gaps in these separation elements are adequately protected.

**A.10. 7.4.7.** The performance conditions of building elements intended to limit the spread of fire and smoke, constructed and carried out in accordance with Article. **A.10.2.3.1.** and Article **A.10.2.3.52.** are those set out in this Annex, corresponding to the respective functions.

**A.10. 7.4.8.** Public spaces for car parking may be provided in existing buildings with mixed functions, provided that they are separated from the rest of the existing construction by walls and floors in accordance with the provisions laid down in this Annex. Only strictly necessary access and traffic gaps, duly protected, shall be allowed in separators.

### **A.10. 7.5. SMOKE EXHAUST (SMOKE EXTRACTION)**

**A.10. 7.5.1.** Smoke ventilation (smoke extraction) is mandatory in the spaces and rooms set out in this Annex according to the specific function(s) and type of existing mixed use building.

**A.10. 7.5.2.** The design and construction of smoke exhaust (smoke extraction), by natural - organized draught or mechanical ventilation in existing buildings with mixed functions, must comply with Art. A.10.9.1. to Art. A.10.9.30. and specific provisions.

**A.10. 7.5.3.** Existing portions of constructions with distinct functions are typically provided with independent smoke evacuation devices in the event of fire, separated from smoke discharges from other functions. The common (horizontal and vertical) circulation and exhaust routes of an existing mixed-function building may be provided with a single smoke exhaust system (smoke extraction), independent of the smoke exhausts from the functional spaces in the existing building.

**A.10. 7.5.4.** For different functions with the same fire risk or fire hazard in the existing building, in technically justified cases, joint smoke exhaust systems may be installed in the event of fire, provided that protective measures are taken to limit the spread of fire between functions by means of ducts penetrating the separating elements (walls, floors).

**A.10. 7.5.5.** The independent release of smoke in the event of fire from crowded rooms, storage facilities for combustible materials and/or substances, as well as other existing rooms and building spaces with mixed functions to be determined by the beneficiary, is mandatory.

**A.10. 7.5.6.** Where smoke evacuation (smoke extraction) from existing rooms and spaces with a high fire risk is mandatory, independent smoke extraction devices or systems shall be provided in such rooms and spaces.

**A.10. 7.5.7.** Niches and ducts for smoke exhaust from a separate function shall not pass through other functions, and where technically justified, the walls of the ducts or flues shall be of reaction to fire class A1, A2s1d0 and with a fire resistance corresponding to the heat load density of the space, but for a minimum of 2 hours (EI/REI120).

**A.10. 7.5.8.** With the exception of stairwells, in all cases natural smoke extraction may be replaced by mechanical smoke extraction under the conditions and subject to the provisions of this Annex.

### **A.10. 7.6. ESCAPE ROUTES IN CASE OF FIRE**

**A.10. 7.6.1.** In existing constructions with mixed functions, escape routes shall be provided in the event of fire in an appropriate number arranged, constructed and dimensioned, in accordance with Article. A.10.2.5.1 Article. A.10.2.5.74. and provisions specific to the respective functions.

**A.10. 7.6.2.** Where the exhaust routes are common to more than one function or to all functions in the existing building, the most stringent performance conditions of the respective functions for which the exhaust is provided shall be met in the design and layout.

**A.10. 7.6.3.** Where the exhaust routes are common to more than one function or to all functions in the existing building, the most stringent performance conditions of the respective functions for which the exhaust is provided shall be met in the design and layout. In portions or areas of the existing construction where those functions result in smaller dimensions of escape routes, their widths may be reduced accordingly;

**A.10. 7.6.4.** Separation of escape routes from adjacent functions (destinations) shall be carried out in accordance with the conditions laid down for those functions and the type of building existing.

**A.10. 7.6.5.** Access openings to escape routes in their partitions shall be protected by closures appropriate to the fire risk (category of danger) and the purpose of each existing function and type of building.

**A.10. 7.6.6.** *As a rule, the common escape staircases of existing mixed-function buildings are enclosed in stairwells, properly constructed and separated from the rest of the existing building. Open/unenclosed interior staircases in stairwells, may be provided only in the cases and under the conditions laid down in this Annex.*

**A.10. 7.6.7.** *The staircase landings associated with basements shall be separated from the staircase landings above ground, including the ground floor of the existing building, in accordance with the provisions of this Annex. Exceptions are the situations mentioned in the regulation.*

**A.10. 7.6.8.** *Vertical traffic and transport routes (stairways, lifts, monte-charge, etc.) shall be separated from the rest of the existing construction by walls and where appropriate floors, which meet the performance conditions set out in this Annex. Access openings in the partition walls shall be protected by means of closures as specified in the Annex.*

**A.10. 7.6.9.** *Where external escape staircases are provided, they shall be so located and constructed that the movement of users is not blocked by flames or smoke produced in the event of fire in the building or in objects located in the vicinity, and shall be protected in accordance with the provisions laid down in this Annex.*

**A.10. 7.6.10.** *When determining fire escape flows, the existing building as a whole is usually considered. Where the escape routes are common, corresponding to the way in which the existing construction is considered to comply with the provisions of Article. **A.10.7.1.3.** and art. **A.10.7.1.4.** (civil (public) production and/or storage), the most stringent protective measures specific to their functions shall be ensured. Where separate (specific) evacuation routes are provided for a function or group of functions, the conditions laid down for that function (s) shall be met when determining the evacuation flows.*

**A.10. 7.6.11.** *The determination of the number of persons for whom evacuation conditions are ensured in the event of fire shall take into account the occupancy level and the maximum simultaneous capacities taken into account, depending on their intended use and layout in the existing construction.*

**A.10. 7.6.12.** *The evacuation capacity of a stream (C) shall be determined in accordance with each of the functions considered, as specified in this Annex, and for the whole existing construction the common escape routes shall ensure the most stringent standard conditions. If there are functions above the level of the existing above-ground construction which provide for the dimensioning of the escape staircase ramps which require - according to the provisions laid down in this Annex - smaller dimensions, these dimensions may be reduced accordingly in those portions. Under no circumstances is it permissible to reduce the dimensions of the escape routes on the route to the outside of the most congested level considered.*

**A.10. 7.6.13.** *The maximum permissible lengths of escape routes shall satisfy the conditions laid down in this Annex for the functions concerned and, for the common escape routes of the existing construction, where applicable, the lengths prescribed for the existing construction shall be respected (Article. **A.10.7.1.3.** and Art. **A.10.7.1.4.**).*

**A.10. 7.6.14.** *The composition and dimensioning of escape routes in the event of fire shall comply with the requirements laid down in this Annex.*

**A.10. 7.6.15.** *The common escape staircases of existing mixed-function buildings will also have access to the terraces of the respective existing buildings when they are very high or with crowded rooms.*

## **A.10. 7.7. SIGNALLING AND FIRE-FIGHTING INSTALLATIONS**

**A.10. 7.7.1.** *Existing buildings with mixed functions shall be equipped and provided with fire signalling and fire-fighting installations and means, in accordance with the way the existing building is considered, according to Art. **A.10.7.1.3.** and Art. **A.10.7.1.4.**, and its various functions*



*in accordance with its intended use and the determined fire risk (danger), according to the provisions of the technical regulations.*

**A.10. 7.7.2.** *Where the beneficiary so requests, the existing building may be equipped and fitted with additional signalling and fire-fighting installations in addition to the provisions of the relevant technical regulations.*

**A.10. 7.7.3.** *In determining the equipment and fittings, account shall be taken of the whole building with mixed functions and the use of installations, equipment, means and extinguishing products appropriate to the fire risks and fire hazard categories of the premises concerned.*

**A.10. 7.7.4.** *For the permanent supervision and control of the operation of fire prevention and fire-fighting installations in existing mixed-use buildings, as a general rule, a central building supervision dispatch centre shall be provided - as far as possible on the ground floor - to monitor the operation of these installations from all parts of the existing building. The different functions may have their own monitoring and control points of the installations with which they are equipped but whose operation will also be signalled at the central dispatcher of the existing building.*

#### **A.10. 7.8. RELATED UTILITY INSTALLATIONS**

**A.10. 7.8.1.** *The fitting, design and construction of utility installations for existing buildings with mixed functions shall be ensured in accordance with the provisions of this Annex and of the specific technical regulations, having regard to the fire hazards (categories) of the functions concerned, (destinations) and to ensure their protection and the adjacent functions from which they are separated.*

**A.10. 7.8.2.** *The utility installations of the existing building will correspond to the established fire hazards and risks (categories of danger) ensuring the limitation of the spread of fire and smoke in the building.*

**A.10. 7.8.3.** *The electrical, heating, plumbing, ventilation, etc. systems and installations must correspond to the fire risks (hazard categories) of the respective uses, the size of the existing buildings and the level of fire stability provided, according to the specific technical regulations.*

**A.10. 7.8.4.** *Spaces and rooms with release of combustible substances shall be ensured that they are released separately and in such a way as not to cause fires or explosions.*

**A.10. 7.8.5.** *Ventilation systems for rooms and spaces with a high fire risk, as well as for the public and crowded rooms, shall be independent of other existing building ventilation systems.*

#### **A.10. 7.9. ACCESS, INTERVENTION AND RESCUE ROUTES**

**A.10. 7.9.1.** *Existing buildings with mixed functions shall be provided with access, intervention and rescue routes in the event of fire, so arranged, designed and constructed that the intervention forces can act quickly and safely, in accordance with the provisions laid down in this Annex.*

**A.10. 7.9.2.** *Existing above-ground constructions with mixed functions, as a rule, must be accessible to emergency vehicles in case of fire, at least on two sides.*

**A.10. 7.9.3.** *External access routes for emergency vehicles (roads, platforms, etc.) must allow access and intervention especially to the more dangerous areas and functions of the existing construction, to those with crowds of people, to the openings (protected or unprotected) in the walls outside perimeters, as well as at water supply sources.*

**A.10. 7.9.4.** *The composition, conformation and reconstruction of the external circulation paths of the emergency vehicles will correspond to the provisions of this annex and of the technical regulations.*

**A.10. 7.9.5.** *The access ways and internal circulations of the existing construction, which also ensure the intervention of the fire brigade personnel in case of fire, are properly equipped and marked, so that they are easy to recognize and use in fire conditions.*

**A.10. 7.9.6.** *For existing building functions requiring special conditions for the rescue of users in the event of fire (sick, handicapped, etc.), access, circulation and rescue routes shall be provided which are suitably dimensioned, laid out and equipped in accordance with the provisions of this Annex and their specific technical regulations.*

#### **A.10. 7.10. THE PROVISION OF INTERVENTION MEANS AND THE FIRE SERVICE**

**A.10. 7.10.1.** *Existing mixed-function constructions shall be equipped with technical means of extinguishing appropriate to the fire classes in the spaces and rooms concerned, in accordance with the provisions of this Annex and their specific technical regulations.*

**A.10. 7.10.2.** *For each function, the necessary technical means of extinguishing (portable, transportable extinguishers, etc.) shall be provided, and for the existing building as a whole, the equipment shall be provided according to the provisions of this Annex, depending on whether it is classified as an existing civil (public) or production and/or storage building - according to Art. A.10.7.1.3. and Art. A.10.7.1.4.*

**A.10. 7.10.3.** *The technical means of extinguishing the existing construction and its various functions shall be arranged in such a way that they can be easily accessible and used in case of need.*

**A.10. 7.10.4.** *The level of equipment and staffing of the fire service of the existing construction with mixed functions shall be determined according to the size of the existing construction, risks (categories of danger) of fire, vulnerability, existing construction type, level of equipment with fixed systems for prevention and extinguishing, etc., in accordance with the specialised regulations.*

**A.10. 7.10.5.** *As a rule, existing mixed-function buildings will have fire services (for the whole building) when the total developed area is 10,000 m<sup>2</sup> or more. Beneficiaries may also set up fire brigade services in smaller areas or even for the different functions set up in the existing construction.*

### **CHAPTER 8**

#### **SPECIFIC PERFORMANCE OF EXISTING MIXED-FUNCTION BUILDINGS**

##### **A.10. 8.1. PERFORMANCE OF MIXED-FUNCTION BUILDING TYPES**

###### **Existing buildings of the ordinary type**

**A.10. 8.1.1.** *Existing buildings of the ordinary mixed-function type are considered to be those that are not tall, very tall, with crowded rooms, existing monoblock armoured buildings.*

*The normal type of construction shall have the risks determined and specified and, where appropriate, the fire hazard categories - i.e. the hazard classes for storage - for each intended use or operation it covers.*

**A.10. 8.1.2.** *Existing buildings of ordinary type with mixed functions may be of fire stability level I to V, provided that the correlation between the fire stability level provided, the risk (category) of danger and the area of the fire compartment is respected, depending on the classification of the existing building as a civil (public) or production and/or storage building, according to Art. A.10.7.1.3. and Art. A.10.7.1.4.*

**A.10. 8.1.3.** *Existing buildings of the ordinary type may be located independently, or grouped or merged with other constructions, under the conditions laid down in this Annex and within the permitted limits of fire compartments.*

**A.10. 8.1.4.** *The positioning in relation to neighbours shall be carried out at the safety distances laid down in Art. A.10.2.2.2. and Table 145 or partitioned by fire walls, or fire resisting walls as appropriate.*

**A.10. 8.1.5.** *By complying with existing ordinary buildings with mixed functions, it will be sought to arrange the more dangerous risk (categories) in separate areas and with the appropriate protective measures so that in the event of fire it does not affect large built areas or endanger neighbouring objects or are endangered by neighbours.*

**A.10. 8.1.6.** *The separate and independent uses and functions in the existing building shall be separated from each other by vertical and, where appropriate, horizontal building elements (walls, floors) corresponding to the respective fire risks (categories of danger), as laid down in this Annex.*

**A.10. 8.1.7.** *Existing buildings normally used for mixed functions shall have fire escape routes suitably dimensioned, designed and constructed in accordance with the provisions of this Annex.*

**A.10. 8.1.8.** *The equipment and fitting out with installations and means of signalling and fire-fighting shall be carried out in accordance with the provisions of the specialist technical regulations, taking into account the existing building as a whole. Beneficiaries may establish equipment and facilities with such installations and means, as appropriate, and outside the mandatory fields.*

**A.10. 8.1.9.** *In order to ensure the conditions for intervention in the event of fire, existing normal buildings shall be provided with access, intervention and rescue routes, in accordance with the provisions of this Annex, in such a way as to allow access for emergency vehicles to at least one side of the building.*

#### **Existing tall, very tall, crowded, monoblock or armoured buildings**

**A.10. 8.1.10.** *Existing building types with mixed functions, can be existing tall and very tall buildings, existing buildings with crowded rooms, existing monoblock or armoured buildings.*

**A.10. 8.1.11.** *In existing buildings with mixed functions, only:*

**a)** *different independent or non-functional civil (public) functions;*

**b)** *civil (public) functions and some of the production and/or storage activities set out in this Annex;*

**c)** *different production and/or storage activities.*

**A.10. 8.1.12.** *In existing high, very high or crowded civil (public) buildings, only civil (public) functions are allowed. The provision of separate production and/or storage functions is strictly prohibited. Exceptions are activities related to civil (public) functions falling within the risk levels (maintenance workshops, publishing, storage, etc.).*

**A.10. 8.1.13.** *In existing monoblock production and/or storage buildings, civil (public) functions may also be arranged, provided they are separated into separate fire compartments.*

**A.10. 8.1.14.** *The specific performances set out in this Annex shall be ensured for each existing construction type and their specific conditions and performances shall be met for the different functions.*

**A.10. 8.1.15.** *In existing civil (public) high, very high or crowded room buildings, the provisions of Art. A.10.7.1.3. and Art. A.10.7.1.4., as these existing buildings are of a civil (public) nature.*

**A.10. 8.1.16.** *The various independent functions in existing civil (public) high, very high or crowded buildings shall be arranged in separate fire compartments with walls and floors of reaction to fire class A1, A2s1d0 fire resistant according to the provisions laid down in this Annex.*

**A.10. 8.1.17.** *The specific performance conditions set out in this Annex shall be fulfilled for each of them.*

#### **A.10. 8.2. PERFORMANCE OF SOME USES IN EXISTING MIXED-FUNCTION BUILDINGS**

**A.10. 8.2.1.** *In existing buildings with mixed functions, civil (public), production and/or storage functions may be arranged in the cases and under the conditions permitted by the Annex.*

**A.10. 8.2.2.** *Separate civil (public) functions that can be arranged in an existing mixed-function building are those for:*

- a)** *housing, administration, tourism, commerce and parking;*
- b)** *administration, commerce, health, tourism and parking;*
- c)** *health, housing and parking, education, sport and parking;*
- d)** *worship, administration, housing and parking.*

**A.10. 8.2.3.** *The civil (public) and production and/or storage functions permitted in an existing construction with mixed functions are those for residential, administrative, commercial and parking purposes, together with production and/or storage activities falling under categories C, D or E (BE2, BE1 or BE1 b) of fire hazard.*

**A.10. 8.2.4.** *The provision in an existing mixed-function building of only production and/or storage activities of fire hazard categories A (BE3a), B (BE3b), C (BE2), D (BE1a) and E (BE1b) shall be permitted subject to the conditions and protective measures laid down in this Annex.*

#### **Mixed civil (public) functions**

**A.10. 8.2.5** *Rooms, spaces and civil (public) functions in the existing building with mixed functions shall have a specific fire risk established and specified, determined in accordance with Art. A.10.2.1.1. to Art. A.10.2.1.3.*

**A.10. 8.2.6** *Depending on the fire hazard and heat load density, each separate civil (public) function shall be separated from the rest of the existing building by walls and floors suitably constructed and constructed in accordance with the provisions laid down in this Annex.*

**A.10. 8.2.7** *Compliance with the existing construction shall aim to separate the high fire risk functions, separating them with fire-resistant building elements corresponding to the density of the thermal load in the spaces concerned and the provisions of this Annex, so as not to endanger other adjacent civil (public) functions or construction.*

**A.10. 8.2.8** *As a rule, civil (public) functions with a high fire risk shall not be arranged under spaces with an agglomeration of persons or, where this is not possible or technically justified, appropriate protective measures shall be provided.*

**A.10. 8.2.9** *The existing mixed-function building shall be provided with a level of fire stability appropriate to meet the conditions of correlation between it and the number of storeys, floor area and maximum simultaneous capacity as laid down in this Annex.*

**A.10. 8.2.10** *In the composition of the existing building and its construction elements, the performance conditions set out in this Part and Art. A.10.2.4.1. to Art. A.10.2.4.60., as well as the specific requirements of Part II of this Annex.*

**A.10. 8.2.11.** *Civil (public) functions arranged in existing constructions shall be separated from each other and from the common traffic and escape routes by fire resistant elements (walls, floors), corresponding to the destinations and type of building existing.*

**A.10. 8.2.12.** *The layout, design and construction of the partitions shall ensure that the spread of fire and smoke to adjacent spaces is limited during normal times and that the function prevents the easy spread of fire and smoke over large areas.*

**A.10. 8.2.13.** *Separation of different functions shall be achieved through walls and, where appropriate, fire resistant floors in accordance with the provisions laid down in this Annex, and any circulation or functional gaps therein shall be protected by suitable closing elements.*

**A.10. 8.2.14.** *The layout and protection will limit the possibilities of fire spreading on the building facades, ensuring fullness between successive gaps in the perimeter walls.*

**A.10. 8.2.15.** *The performance requirements for fire and smoke spread limitation elements shall be as laid down in this Annex Art. A.10.2.3.1. to Art. A.10.2.3.52.*

**A.10. 8.2.16.** *Public spaces for parking cars shall be separated from the rest of the existing building with mixed functions by walls and floors of fire reaction class A1, A2s1d0 with fire resistance standardized according to the annex and in which only the gaps strictly necessary for functional circulation are allowed, adequately protected with closing elements, according to the provisions of this annex.*

**A.10. 8.2.17.** *Smoke evacuation (smoke extraction) in the event of fire from spaces with crowded rooms and their escape routes, horizontal and vertical common circulations, and stores of combustible materials or substances, in the situations set out in this Annex, shall be provided naturally-organised or mechanically,*

**A.10. 8.2.18.** *Smoke exhaust (smoke extraction) systems shall be self-contained for the spaces set out in this Annex and their ducts and flues shall not constitute fire and smoke propagation routes into the building.*

**A.10. 8.2.19.** *The construction of common smoke exhaust systems (smoke extraction) is permitted only in the cases and under the conditions set out in this Annex.*

**A.10. 8.2.20.** *Existing civil (public) mixed-function buildings may have evacuation routes common to all civil functions, or separate for one or more civil (public) functions in the building.*

**A.10. 8.2.21.** *Exhaust ducts shall be dimensioned, laid out, constructed and built in accordance with the provisions of this Annex and functional access openings thereto shall be adequately protected.*

**A.10. 8.2.22.** *When dimensioning the exhaust ducts of existing buildings with mixed civil (public) functions, their specific provisions shall be observed.*

**A.10. 8.2.23.** *The provision of fire signalling and fire-fighting installations in existing buildings with mixed civil (public) functions, as well as in their separate functions, shall be carried out in accordance with the provisions of this Annex and the relevant technical regulations.*

**A.10. 8.2.24.** *The associated utility installations shall comply with the provisions of the specialised technical regulations appropriate to the fire destinations and risks.*

**A.10. 8.2.25.** *Existing buildings with mixed civil (public) functions shall have access, intervention and rescue routes so distributed, laid out, marked, equipped and constructed as to allow easy intervention in the event of fire.*

**A.10. 8.2.26.** *As far as possible, existing buildings with mixed civil (public) functions should be accessible to emergency vehicles on all facades, but at least two.*

**A.10. 8.2.27.** *Access, intervention and rescue routes for civil (public) functions for persons to be transported by stretcher, trolley, etc. shall be appropriately dimensioned.*

**A.10. 8.2.28.** Existing buildings and existing civil (public) functions thereof shall be equipped with means of first intervention appropriate to their intended use and fire class, in accordance with the provisions of this Annex.

**A.10. 8.2.29.** Buildings with mixed civil (public) functions will have fire services established according to specific regulations.

**Existing mixed civil (public) functions and some existing production and/or storage activities**

**A.10. 8.2.30.** The distinct functions, the rooms and their spaces, permitted in the existing construction with mixed functions in accordance with the provisions of this Annex, shall have the risks, namely the fire hazard categories, determined in accordance with Article. **A.10.2.1.1** Article. **A.10.2.1.7.** of this annex.

**A.10. 8.2.31.** In accordance with the risks and fire hazard categories established and the density of the heat load, each distinct operation shall be separated from the rest of the existing construction by appropriate sited, constructed and dimensioned walls and floors.

**A.10. 8.2.32.** By conforming the existing construction, it is ensured that the hazardous or high fire risk functions are separated by appropriately constructed and dimensioned building elements, in accordance with the provisions laid down in this Annex, so as not to endanger other functions or the construction.

**A.10. 8.2.33.** It is recommended that civil (public) functions be arranged in separate areas of existing construction levels from production or storage. Where it is not technically possible or justified, appropriate separations shall be ensured. It is not recommended to arrange civil (public) functions directly over deposits of combustible materials or substances with hazard class P4 or P5 and heat load density greater than 840 MJ/m<sup>2</sup> and when this is not possible, only by taking measures to prevent the spread of fire and smoke (separations, protection with covers above windows, equipping with automatic signalling and extinguishing systems, etc.).

**A.10. 8.2.34.** The existing construction with mixed functions shall ensure the level of fire stability appropriate to meeting the correlation conditions between it and the built area, the number of levels, the maximum capacity and the risk (category) of fire, as applicable, in accordance with the provisions of the Annex, taking into account how the existing construction is considered to be in accordance with Article. **A.10.7.1.3** and Article **A.10.7.1.4.**

**A.10. 8.2.35.** The existing construction and the building elements associated with it shall be constructed in such a way as to meet the common and specific performance conditions set out in this Annex.

**A.10. 8.2.36.** The different distinct functions of the existing construction shall be separated from each other and from the common traffic and escape routes by construction elements (walls, floors) corresponding to the provisions of this Annex.

**A.10. 8.2.37.** The separating elements of the functions shall be so arranged, designed and constructed as to limit the spread of fire and smoke into adjoining spaces during the standard time (as specified in the Annex), and within each function to prevent the spread of fire and smoke over large areas.

**A.10. 8.2.38.** Traffic or functional gaps in the separation elements shall be protected by shut-off elements in accordance with the provisions laid down in this Annex, depending on their role for fire safety.

**A.10. 8.2.39.** The construction elements provided for limiting the spread of fire and smoke shall be designed and constructed in accordance with Art. **A.10.2.3.1.** to Art. **A.10.2.3.52.** and the specifications in Sections **II, III** and **IV** of the Annex.

**A.10. 8.2.40.** Smoke evacuation (smoke extraction) in the event of a fire shall be provided in accordance with the conditions and functions laid down in the building, (natural-organised or mechanical) as specified in the Annex.

**A.10. 8.2.41.** Smoke exhaust (smoke extraction) shall be carried out in accordance with the provisions of this Annex relating thereto (Art. A.10.9.1. to Art. A.10.9.35.) and it is mandatory to provide independent systems for civil (public) functions from production and storage.

**A.10. 8.2.42.** Existing constructions may have escape routes common to all their distinct functions, or separate for different functions.

**A.10. 8.2.43.** The escape routes shall be arranged, constituted, dimensioned and carried out in accordance with the provisions of this Annex in accordance with the functions of the existing construction in such a way as to meet the specific performance levels.

**A.10. 8.2.44.** The provision and construction of the fire signalling and extinguishing systems shall correspond to the respective functions and the fire classes laid down.

**A.10. 8.2.45.** The design and construction of the related utility installations shall comply with the provisions of the specialised technical regulations, appropriate to the intended use, risks and hazards of fire, and to the type of existing construction.

**A.10. 8.2.46.** Existing buildings shall be provided with access, intervention and rescue routes so distributed, laid out, marked, equipped and constructed as to allow easy intervention in the event of fire.

**A.10. 8.2.47.** As a rule, existing buildings must be accessible to fire engines from at least two frontages, on appropriate traffic routes.

**A.10. 8.2.48.** The existing distinct functions and existing constructions shall be equipped with technical means of extinguishing appropriate to their intended purpose and fire class, in accordance with the provisions of the Annex.

**A.10. 8.2.49.** Where the developed area of existing buildings falls within the limits set out in this Annex for civil (public) or production and storage functions, fire services shall be established.

#### **Existing mixed production and/or storage functions**

**A.10. 8.2.50.** The distinct production and/or storage functions of existing buildings with mixed functions shall have specific fire hazard categories determined and specified, in accordance with Article. A.10.2.1.4 to Article. A.10.2.1.7.

**A.10. 8.2.51.** In accordance with the established fire hazard categories, intended use and heat load density, each function, including its rooms, shall be separated from the rest of the existing building by walls and floors suitably located, constructed and dimensioned in accordance with the provisions laid down in this Annex.

**A.10. 8.2.52.** Compliance with the existing construction ensures that hazardous functions are arranged separately and separated by walls and, where appropriate, floors so as not to endanger other functions or existing construction. Spaces, rooms and explosion hazard functions, categories A or B (BE3a or BE3b), as far as possible, shall be arranged at the top of the existing construction. Where it is not technically possible or justified, appropriate protection and separation measures shall be taken.

**A.10. 8.2.53.** The existing building will be provided with the appropriate level of fire stability to meet the conditions of correlation with the built-up area, fire hazard category and number of levels.

**A.10. 8.2.54.** The building elements and the existing construction as a whole shall be so constructed as to meet the reaction to fire conditions specific to them.

**A.10. 8.2.55.** *The distinct functions arranged in the existing construction shall be separated from each other and from the common traffic and escape routes, through walls and floors corresponding to the fire hazard categories, the density of the thermal load and the conditions under which the fire stability level is assigned.*

**A.10. 8.2.56.** *The arrangement and composition of the separating building elements will ensure that the propagation of fires is limited to adjacent functions as well as over large areas of that function.*

**A.10. 8.2.57.** *The necessary circulation or functional gaps of the separation elements shall be protected by appropriate elements depending on the hazard category and the role of the separator.*

**A.10. 8.2.58.** *The construction elements intended to limit the spread of fire and smoke shall be constituted and carried out in accordance with the provisions of this Annex relating to existing production and/or storage structures (Article. A.10.2.3.1 to Article. A.10.2.3.52.).*

**A.10. 8.2.59.** *It is mandatory to ensure smoke evacuation (smoke extraction) from the rooms and functions listed in the Annex, according to the provisions of Art. A.10.9.1. to Art. A.10.9.35. and specific requirements.*

**A.10. 8.2.60.** *Smoke extraction (smoke extraction) from storage rooms with an area greater than 36m<sup>2</sup> for combustible materials and substances shall be provided independently.*

**A.10. 8.2.61.** *In cases where it is mandatory to evacuate smoke in accordance with the provisions laid down in this Annex, it may be carried out naturally – organised or mechanically.*

**A.10. 8.2.62.** *Existing constructions may have escape routes common to all functions or distinct for one or more functions.*

**A.10. 8.2.63.** *Escape routes shall be arranged, constituted and sized as appropriate to the fire hazard categories and destinations concerned, ensuring their separation by appropriate building elements.*

**A.10. 8.2.64.** *Existing constructions shall be equipped with signalling and fire-fighting installations in accordance with the relevant technical regulations.*

**A.10. 8.2.65.** *The associated utility installations shall be designed and carried out in accordance with specific regulations, according to the hazard categories established and the destinations.*

**A.10. 8.2.66.** *Access, intervention and rescue routes in the event of fire shall be provided in accordance with the provisions of this Annex relating to existing production and/or storage structures so as to permit easy intervention, in particular to functions involving a high fire hazard.*

**A.10. 8.2.67.** *Access for emergency vehicles shall be provided in accordance with the provisions laid down in this Annex, so that intervention is possible on at least two sides of the existing building.*

**A.10. 8.2.68.** *Existing structures and separate functions shall be equipped with technical means of extinguishing, depending on the hazard and their fire classes, in accordance with the provisions laid down in this Annex.*

**A.10. 8.2.69.** *Existing buildings with mixed production and/or storage functions shall have fire services set up in accordance with the provisions of this Annex and the relevant regulations.*



## Section V

### SMOKE DISCHARGE (SMOKE EXTRACTION) AND HOT GASES

#### CHAPTER 9

#### SMOKE AND HOT GAS EXHAUST

##### General provisions

**A.10. 9.1.** *The purpose of smoke extraction is to remove part of the smoke and combustion gases from the fire in order to ensure evacuation conditions for users and the use of fire-fighting equipment and to limit the spread of fires. In constructed and unenclosed spaces with a free area over 10,400 m<sup>2</sup>, smoke and hot gases shall be exhausted to the outside in accordance with the regulations and this Annex.*

**A.10. 9.2.** *In principle, the removal of smoke is ensured by natural, organized draft or mechanical ventilation, achieving the circulation of air in the considered space and the evacuation of smoke in relation to the air introduced, or by pressure differences between the protected space and the one on fire placed in depression, or by a combination of the two methods.*

**A.10. 9.3.** *The smoke exhaust ducts (smoke vents) in case of fire (smoke extraction) must meet the following general technical requirements:*

- *the section is at least equal to the free surface of the exhaust outlets of a construction level to which they are connected;*
- *the ratio between the sides of the section of the channels (guides) is not greater than 2;*
- *the ducts (niches) shall be made of materials of reaction to fire class A1, A2s1d0, fire resistant for at least 15 minutes (E15), unless the provisions of the standard and of this Annex specify higher strengths; where smoke vents pass through rooms for purposes other than those for which they are intended, they shall have the same fire resistance as the walls or floors bounding that purpose;*
- *the main flues shall be vertical, with deviations of not more than 2% being permitted;*
- *the lengths of the horizontal connections of the smoke exhaust ducts between the outlets and the vertical ducts shall be as short as possible.*

**A.10. 9.4.** *The air inlet and smoke outlet openings (vents) shall be distributed alternately and as evenly as possible throughout the protected space so as to ensure air circulation and smoke exhaust, meeting the specific conditions laid down in the standard and this Annex.*

**A.10. 9.5.** *Air inlets can be achieved by:*

- *gaps (holes) in façades;*
- *doors of rooms that open out, in the external walls of the building;*
- *rooms or corridors with overpressure (the calculation must cover the surplus), or which are well ventilated;*
- *stairways not enclosed in stairwells;*
- *insertion gaps (holes), whether or not connected to channels and cheques.*

*Smoke evacuation shall be provided by roof holes or external walls, in accordance with the Rules and this Annex.*

**A.10. 9.6.** *Protection devices (shutters) for inlet or outlet openings must be made with automatic or manual actuation, in accordance with the provisions of the standard and this Annex. Automatic operation of protective devices shall always be coupled with manual operation.*

*In addition, in buildings fitted with automatic fire-extinguishing systems, the personnel present in the protected space shall be provided with the possibility of operating the system locally before the fire-extinguishing system is switched on.*

**A.10. 9.7.** *The devices for actuating the protective devices (shutters) of the gaps shall ensure:*

- the opening of the gaps and channels in the volume under consideration;*
- the shut-off of ventilators which are not provided for smoke evacuation in the event of fire (smoke extraction).*

**A.10. 9.8.** *The centralised or local manual control of the opening devices may be achieved by mechanical, electrical, pneumatic or hydraulic system.*

*Depending on the type of construction and specific provisions, the centralised manual control shall be placed at the fire service or at the main access of the construction.*

**A.10. 9.9.** *Automatic control of the devices for the protection of gaps (hydrants) shall be provided by the fire alarm installation in the room or space concerned or by local devices (fusible link) where no fire alarm installation is provided.*

**A.10. 9.10.** *The provision of smoke extraction devices and exhaust systems for smoke and hot gases produced in the event of fire is mandatory in the situations and under the conditions laid down in these regulations.*

### **Smoke evacuation (smoke extraction)**

#### **Natural draught - organised**

**A.10. 9.11.** *Smoke extraction by natural draught - organised is carried out by means of air inlets and smoke outlets communicating with the outside directly or through ducts (chimneys), so arranged, dimensioned and designed as to ensure the circulation of air in the protected volume and the evacuation of smoke.*

**A.10. 9.12.** *The introduction of air shall be carried out in accordance with Art. A.10.9.5., and smoke exhaust through openings in the facades (free or closed with devices that open automatically in case of fire), through ducts and niches, or through devices (hatches) with automatic opening in the roof or in the upper third of the outer walls of the room. Smoke extraction devices in the outside walls provide smoke extraction for a maximum depth of 30.00 m (including corridors).*

**A.10. 9.13.** *Smoke extraction devices in the event of a fire shall have a standard free area in relation to the area of the room they protect, as specified in the standard.*

**A.10. 9.14.** *Permanently open natural ventilation gaps, practiced in the roof or in the upper third of the external walls, add up to the free surface required for smoke removal.*

**A.10. 9.15.** *Protective devices for smoke vents (shutters, panels, hatches, etc.) must be (in the stand-by position) made of materials of reaction to fire classes A1, A2s1d0 fire-tight for air inlets and fire-resistant for outlets, with a fire resistance equal to that of the duct on which they are mounted. For gaps provided in the roof or in external walls, these conditions are not mandatory.*

#### **Mechanical smoke extraction**

**A.10. 9.16.** *Smoke extraction by mechanical ventilation is provided by mechanical smoke evacuation and natural or mechanical introduction of air so as to ensure air circulation in the protected space and smoke evacuation. Mechanical smoke extraction can also be provided by creating overpressure in the smoke-protected space (buffer rooms, protected clearances, stairwells, etc.).*

**A.10. 9.17.** *The natural introduction of air is carried out according to Art. A.10.9.5., and the mechanical introduction through inlets connected through ducts (niches) to an introduction fan.*

**A.10. 9.18.** Smoke evacuation shall be provided by wells connected through channels (ducts) to the exhaust fan (extraction).

**A.10. 9.19.** Channels (niches) must, as a rule, meet the conditions laid down in Art. A.10.9.3. and in addition shall be airtight.

**A.10. 9.20.** The air velocity at the inlets shall not exceed 5 m/s and the mechanical inlets shall provide at least 60% of the exhaust flow.

**A.10. 9.21.** The smoke vents must be protected with shutters made of materials of reaction to fire class A1, A2s1d0, fire-tight at the inlets and fire-resistant at the outlets in the stand-by position, with a resistance equal to that of the duct. It is not mandatory to prescribe the shutters when the channels (niches) relate to a single built level.

**A.10. 9.22.** The ratio of the long side to the short side of an inlet or outlet opening shall not exceed 2.

**A.10. 9.23.** The devices for operating the protective shutters shall be made in accordance with Art. A.10.9.6. to Art. A.10.9.9. and shall ensure automatic operation of the defrosting fans.

**A.10. 9.24.** Smoke exhaust fans must be designed so that they can operate at a smoke temperature of 400 °C for at least one hour. The connection between the fan and the column (niche) is made of materials of reaction to fire class A1, A2s1d0.

**A.10. 9.25.** The operating or non-functioning status of the fans related to smoke extraction will be reported to the fire service or other places where permanence is ensured.

**A.10. 9.26.** Installations, including smoke extraction fans, must be electrically powered from a normal source and a backup electrical source.

**A.10. 9.27.** The normal ventilation or conditioning system of an existing building may also be used for the exhaust of smoke produced in the event of a fire (smoke extraction) if it meets all the conditions specific to smoke extraction.

### **Specific conditions for smoke extraction**

#### **Closed stairwells**

**A.10. 9.28.** In order to avoid smoke flooding of enclosed stairwells, they can be vented by natural - organised draught or by overpressurising the adjacent rooms with which they communicate. Mechanical smoke evacuation from stairwells is not permitted.

**A.10. 9.29.** The smoke extraction by natural - organized draught of the closed stairwell is achieved by automatic and manual opening of the smoke exhaust device (located in the upper third of the top level of the stairwell) and the air inlet (opening) (provided at the bottom of the stairwell).

**A.10. 9.30.** Preventing smoke from entering escape stairwells by overpressure from adjacent rooms with which they communicate is achieved by mechanically introducing air into the stairwell, or by mechanically exhausting smoke from adjacent rooms with which they communicate, or by a combination of the two methods (as shown in Figure 277). The overpressure achieved at the stairway enclosure doors, shall be between **20** and **80 Pa**. The flow must ensure a velocity of at least 0.5m/s in front of the access doors to the level under fire, considering closed doors on the other levels. The stairwell at the top shall have a smoke escape device (hatch) with a free area determined according to the standard, but at least 1 m<sup>2</sup>, with the possibility of opening by control from the stair access level. The opening of the device (hatch) shall also be controllable from the fire service. Where accesses to stairway enclosures are protected by buffer spaces, overpressure shall be provided in the buffer spaces.

**A.10. 9.31.** In order to avoid smoke flooding of the horizontal enclosed common spaces of existing buildings, they may be pressurised above the adjacent rooms with which they communicate, or they may be vented by natural - organised draught or mechanical ventilation.

**A.10. 9.32.** Ensuring the evacuation of smoke from closed horizontal common circulations is mandatory in the situations set out in the regulations.

#### **Closed horizontal common circulations**

**A.10. 9.33.** When adjacent rooms are provided with smoke vents, (natural-organised or mechanical) the horizontal common circulations no longer require deflating, providing an overpressure of approx. 20 Pa in relation to the rooms with which they communicate directly or from which they are isolated by overpressure buffer rooms.

**A.10. 9.34.** The natural-organised draught smoke extraction of closed horizontal common circulations shall be carried out under the conditions laid down in Art. A.10.9.11. to Art. A.10.9.15. according to the following rules:

- air inlets and smoke outlets (vents) shall be arranged alternately at horizontal distances - measured in the axes of circulation - not exceeding **10.00 m** in a straight line or **7.00 m** in a broken line;
- doors to publicly accessible rooms should be located more than 5.00 m from any inlet or outlet;
- the intake and exhaust openings will have surfaces of at least **0.10 m<sup>2</sup>** for each exhaust flow of the common horizontal circulation in the area they exhaust;
- the apertures will be arranged with their highest part to the maximum **1.00 m** above the floor and the exhaust outlets shall have a minimum of bottom (floor) **1.80 m** floor coverings (to be in the upper third of the common circulation);

Openings in façades may constitute insertion and/or evacuation pins, provided that they comply with the specified arrangement conditions.

**A.10. 9.35.** The mechanical smoke removal of closed horizontal common circulations is carried out in accordance with the provisions of Art. A.10.9.16. to Art. A.10.9.27. and according to the following rules:

- air inlets and smoke outlets shall be arranged alternately, depending on the location of the fire hazard, at horizontal distances - measured in the axes of circulation - of not more than **15.00 m** in a straight line and **10.00 m** in a broken line;
- doors to publicly accessible rooms should be located more than **5.00 m** from any inlet or outlet;
- inlets shall have their top side not more than **1.00 m** from the floor and outlets shall have their bottom side (parapet) not less than **1.80 m** from the floor (must be in the upper third of the common circulation);
- the common circulation portions between a smoke outlet and an air inlet shall have an extraction flow of at least **0.5 m<sup>3</sup>/s** for each exhaust flow provided.

During smoke removal operation, the pressure difference between the exhaust stairwell and the smoke-free horizontal common circulation must be less than **80 Pa**, at all closed staircase doors.

#### **Evacuation of smoke and hot gases**

**A.10. 9.36.** In the situations laid down in the Annex and the Rules, in order to limit the spread of fire in buildings without internal partitions to ensure the evacuation of smoke and hot gases by natural-organised draught, systems shall be provided (in the roof) consisting of exhaust devices and vertical screens of reaction to fire class A1, A2s1d0, lowered below the ceiling, depending on the heat load density of the spaces concerned, in accordance with Table 174.

**A.10. 9.37.** Devices for the evacuation of smoke and hot gases shall be distributed as evenly as possible and provided with automatic and manual opening. Permanently open gaps (vents) in the roof or in the upper third of the exterior walls add up to the area required to evacuate hot gases.

**A.10. 9.38.** Where mechanical release of smoke and hot gases is planned, it shall comply with the following conditions:

- layout of screens reaction class to fire **A1, A2s1d0** below the ceiling, corresponding to the specific provisions for discharge by natural draught – organised (Art. **A.10.9.36.** and Art. **A.10.9.44.**):
- provision of outlets shall be such as to ensure at least one outlet per maximum **320 m<sup>2</sup>**;
- the extraction flow of an outlet shall be at least **1 m<sup>3</sup>/s per 100 m<sup>2</sup>** bounded by screens and at least **1.5 m<sup>3</sup>/s** per room;
- a maximum of two volumes bounded by screens may be connected to an exhaust fan and the flow rate of the fan may be reduced to the flow rate required by the largest connected volume;
- air can be introduced mechanically or naturally via the bottom of the walls as close as possible to the floor.

**A.10. 9.39.** The provision of hot gas discharge devices shall not be required in existing construction areas which are less than 30 m from external walls having in the upper third of rooms openings or windows fitted with movable meshes which automatically open in the event of fire, with the required free surface and provide for the evacuation of hot gases. When manual operation cannot take place close to the exhaust devices (hatches, windows, etc.) and the centralisation of controls is not technically justified, it is permissible that they are not manually operated. In the case of the use of hot gas exhaust device systems, it is no longer mandatory to provide smoke exhaust devices (smoke extraction).

**A.10. 9.40.** Automatic opening of smoke outlets and hot gases in the event of fire may be made individually or in a group.

**A.10. 9.41.** In existing constructions with automatic extinguishing systems, the automatic actuation of hot gas exhaust devices shall take place after the extinguishing systems have been triggered.

**A.10. 9.42.** In existing constructions equipped with skylights, the exhaust of hot gases must be provided by means of movable meshes which comply with the conditions of hot gas exhaust devices. Exceptions are the situations specified in Art. A.10.9.39

**A.10. 9.43.** In existing multi-storey buildings, smoke and hot gas exhaust shall be provided separately for each storey and the respective ducts passing through other storeys shall have walls of reaction to fire class A1, A2s1d0 with a fire resistance of at least 1 hour (EI/REI60). Exceptions shall be made for specific, technically justified situations which are laid down in specific regulations.

**A.10. 9.44.** The screens will lower below the ceiling in such a way that their lower edge is usually as low as possible, but at least **50 cm** below the ceiling. The height of screens below the ceiling may be reduced by a maximum of **1/3**, if equivalent conditions to limit the lateral propagation of hot gases below the roof of the rooms are achieved by their spacing less than that specified in Table 174 and through the provided opening surface. In rooms with suspended ceilings, the continuity of the gaps between the suspended ceilings and the load-bearing floor must be interrupted in front of the screens with material of reaction to fire class A1, A2s1d0.

**A.10. 9.45.** The screens shall be so constructed and arranged as to make a casing of the space under the roof. Each cassette shall be provided with at least one hot gas evacuation device. Screens are usually arranged on the side of the resistance elements in the potential fire risk area. It is not permissible for fuel elements to cross screens.

**General note Annex 10: if for the compliance of interventions to existing buildings (when they do not change their use) there are provisions in Annex 10 that are more restrictive than the performance provisions required for new buildings, those provisions required for new buildings (less restrictive) will apply.**

## **ANNEX 11 - SMOKE AND HOT GAS EXHAUST SYSTEMS**

*(313) The aerodynamic free area of the air inlets is the total unobstructed cross-sectional area (geometric free area), measured in the area with the smallest cross-section, as shown in the figures.*

*(314) In buildings having buffer rooms to stairwells, enclosed stairwells which have windows directly to the outside through which smoke can escape shall be provided with a smoke extraction device. The free aerodynamic area of self-opening devices for the evacuation of smoke in the event of a fire by natural-organised draught must represent at least 5% of the area of the highest level of the enclosed stairwell, but at least 1 m<sup>2</sup>. Buffer rooms for access to stairs are put under overpressure. The design and calculation of the system is based on **SR EN 12101-6** - Systems for the control of smoke and hot gases. Part 6: Specification for pressure differential systems. Kits (mandatory) and **SR EN 12101-13** - Smoke and heat control systems. Part 13: Pressure differential systems (PDS). Design and calculation methods, installation, acceptance testing, routine testing and maintenance.*

*(315) In buildings that have stairwells, enclosed stairwells that do not have direct windows to the outside through which smoke can escape, and stairwells that have stairwell access buffers, the design and calculation of the system shall be based on **SR EN 12101-6** - Smoke and heat control systems. Part 6: Specification for pressure differential systems. Kits (mandatory) and **SR EN 12101-13** - Smoke and heat control systems. Part 13: Pressure differential systems (PDS). Design and calculation methods, installation, acceptance testing, routine testing and maintenance.*

*(316) Over-pressurisation, design and calculation of the system based on standards **SR EN 12101-13** - Smoke and heat control systems Part 13: Pressure differential systems (PDS). Design and calculation methods, installation, acceptance testing, routine testing and maintenance, and **SR EN 12101-6** - Smoke and heat control systems. Part 6: Specification for pressure differential systems. Kits (mandatory) shall be in accordance with the design requirements of a PDS (door opening force, pressure difference, airflow velocity, initiation time, operating time and response time), bearing in mind that the PDS must be designed so that it can perform its function throughout the required service life.*